

DRESSING & TISSUE FORCEPS

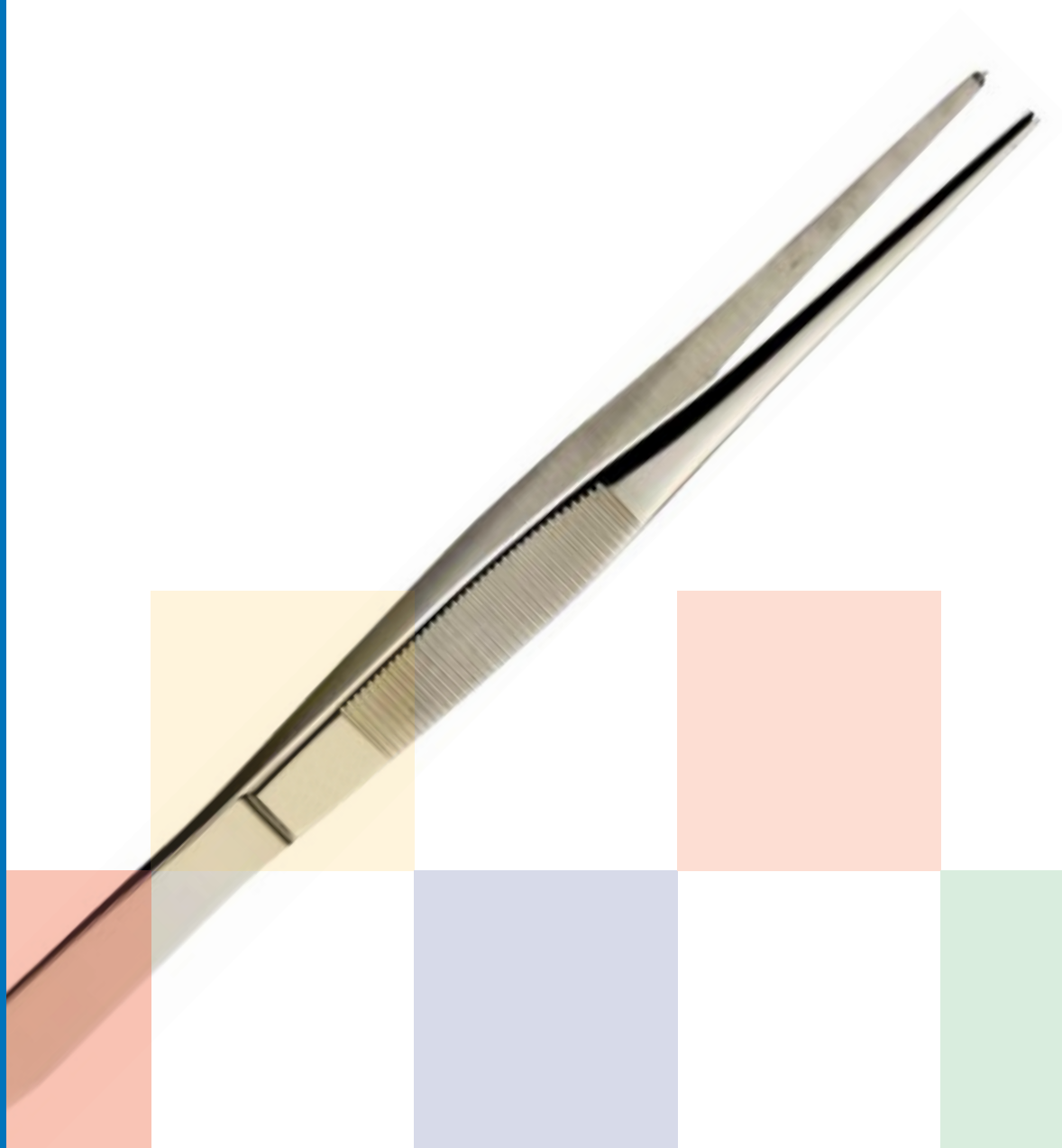

14

Dressing Forceps

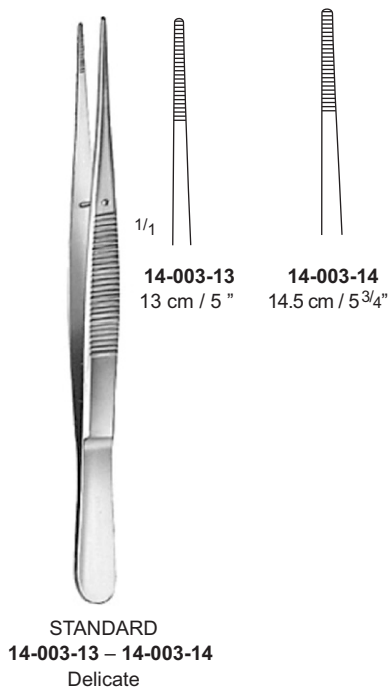
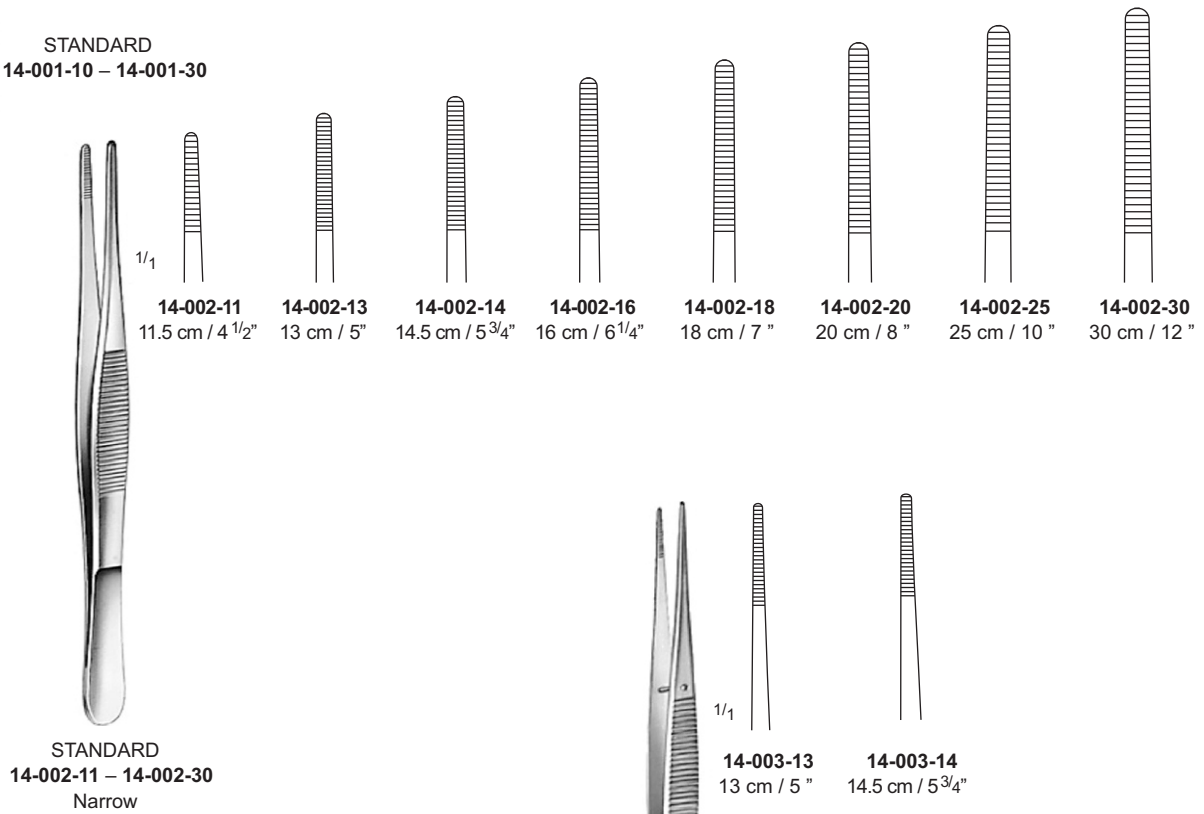
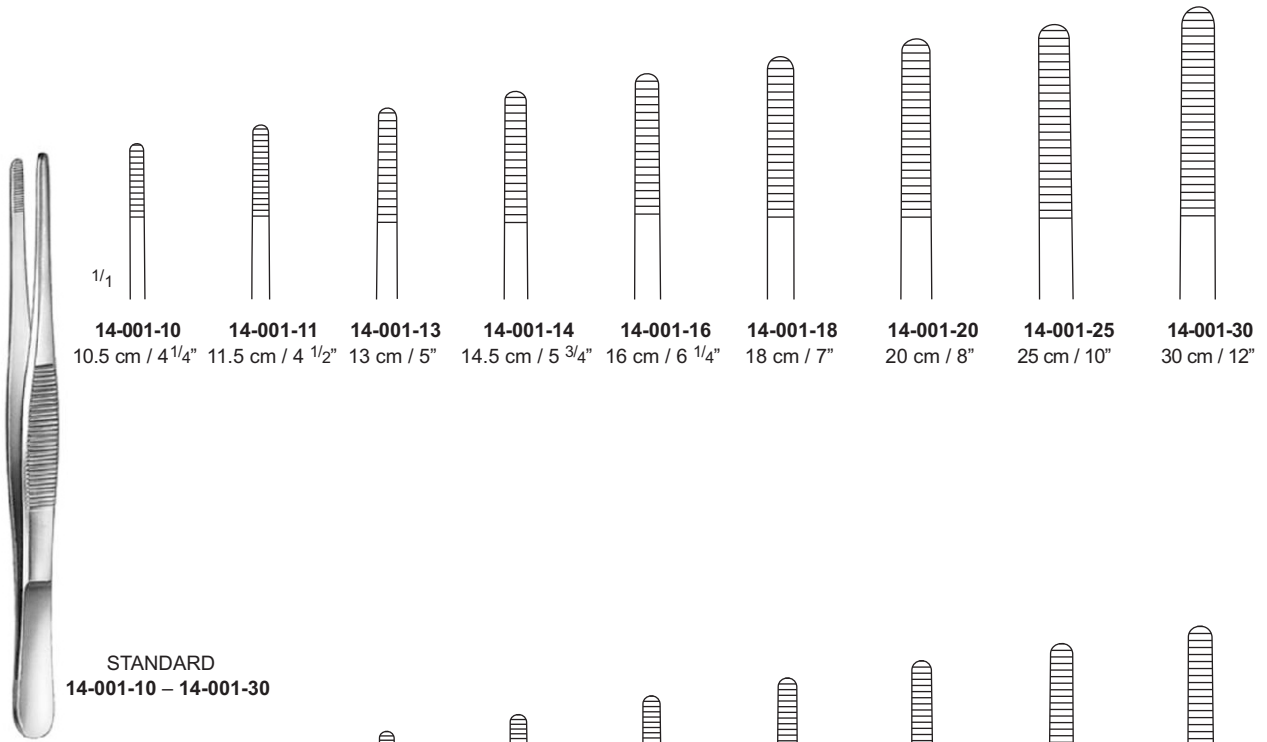

Tissue Forceps

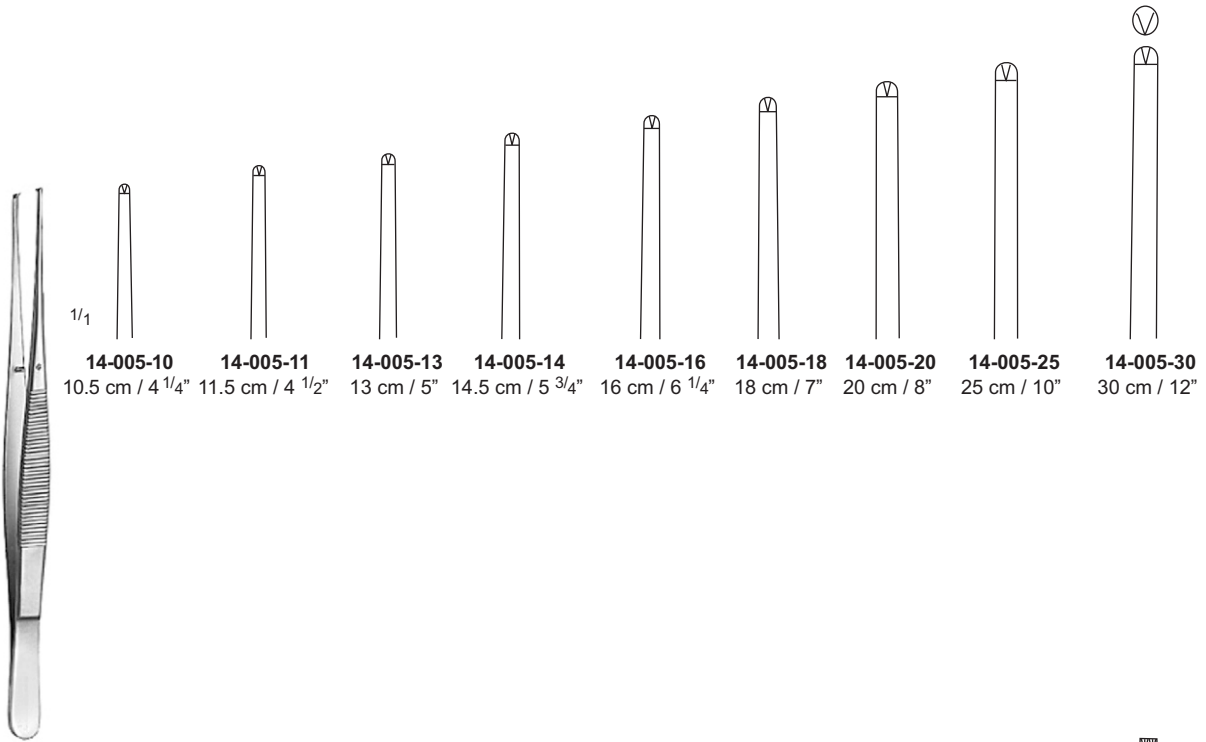

14-005-14 – 14-005-30
 1 x 2 teeth

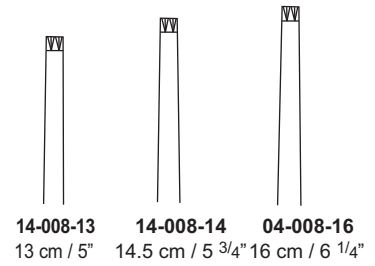

14-008-13 13 cm / 5"
 14-008-14 14.5 cm / 5 3/4"
 04-008-16 16 cm / 6 1/4"

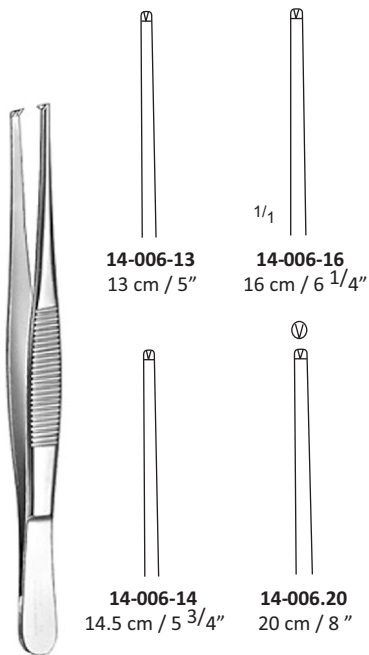

MEDIUM
 14-006-13
 1 X 2 teeth

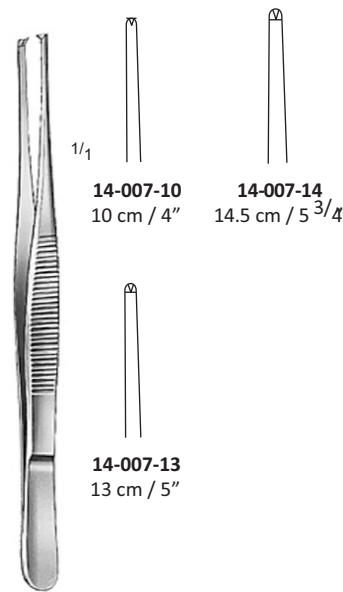

DELICATE
 14-007-13
 1 X 2 teeth

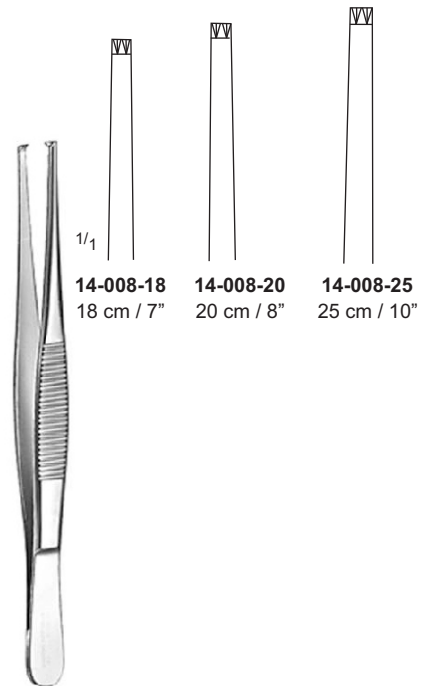

14-008-13 - 14-008-25
 2 x 3 teeth

Tissue Forceps



1/1

14-009-14
14.5 cm / 5 3/4"



14-009-16
16 cm / 6 1/4"

14-009-14 – 14-009-16
3 x 4 teeth



1/1

14-010-13
13 cm / 5"



14-010-16
16 cm / 6 1/4"

14-010-13 – 14-010-16
4 x 5 teeth



1/1

LERCHE
14-010-15
15 cm / 6"
5 X 6 teeth

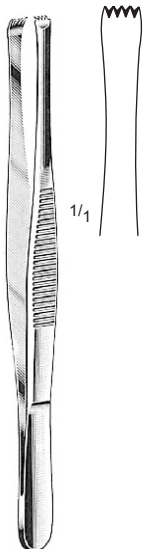

1/1

STONE
14-011-15
15 cm / 6"
5 x 6 teeth



1/1

14-012-15
15 cm / 6"
2 x 3 teeth



14-012-20
20 cm / 8"
2 x 3 teeth



14-013-15
15 cm / 6"
4 x 5 teeth



14-013-20
20 cm / 8"
4 x 5 teeth

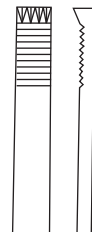

14-013-25
25 cm / 10"
4 x 5 teeth

ALDERKRUETZ
14-012-15 – 14-013-25

Adson Forceps, with Tungsten Carbide T/C Inserts

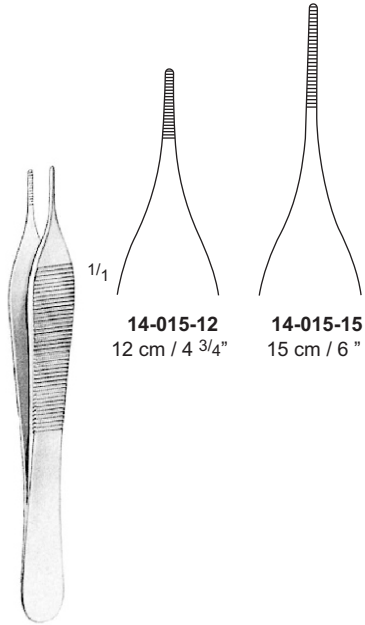

ADSON
 14-015-12 – 14-015-15

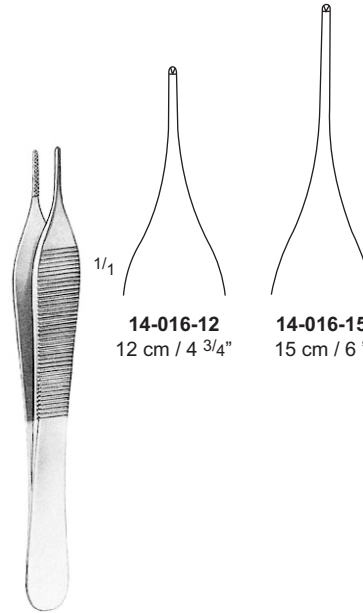

ADSON
 14-016-12 – 14-016-15
 1 x 2 teeth

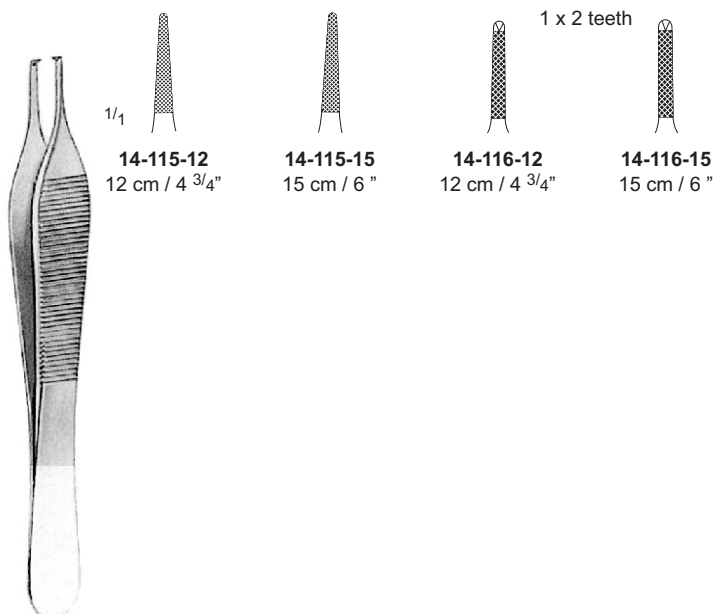

ADSON T/C
 14-115-12 – 14-116-15

Micro Tissue Forceps, with Tungsten Carbide T/C Inserts

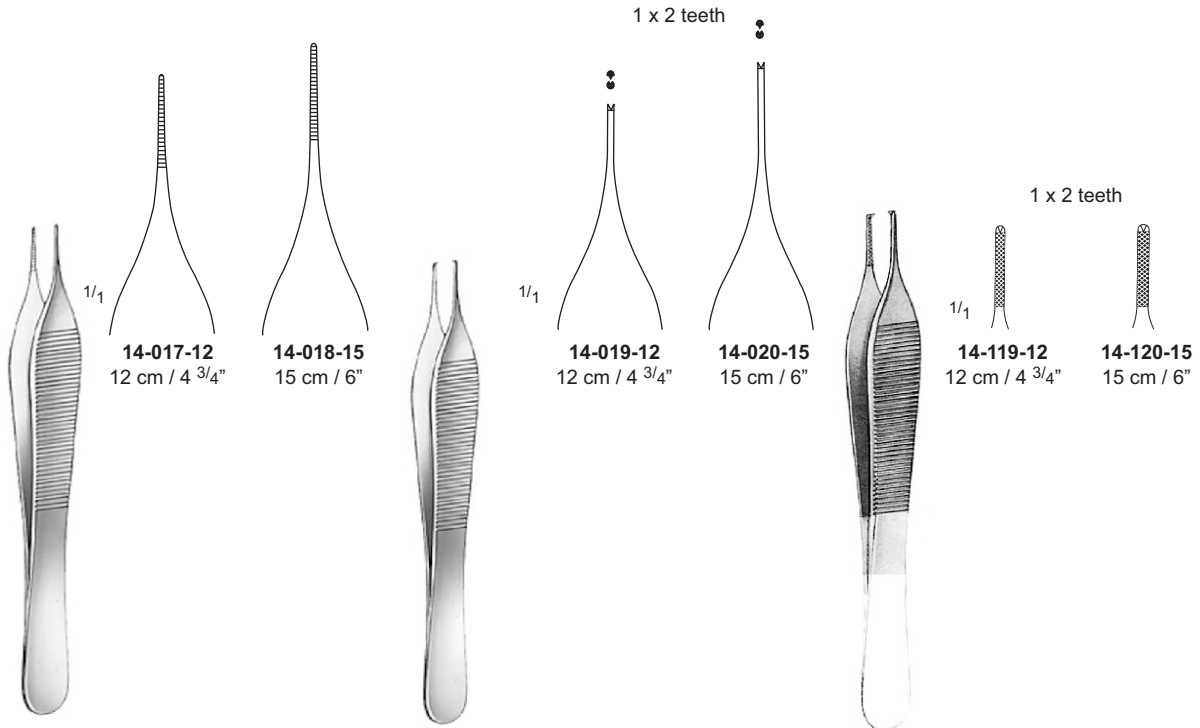

MICRO ADSON
 14-017-12 – 14-018-15

MICRO ADSON
 14-019-12 – 14-020-15

MICRO ADSON T/C
 14-119-12 – 14-120-15

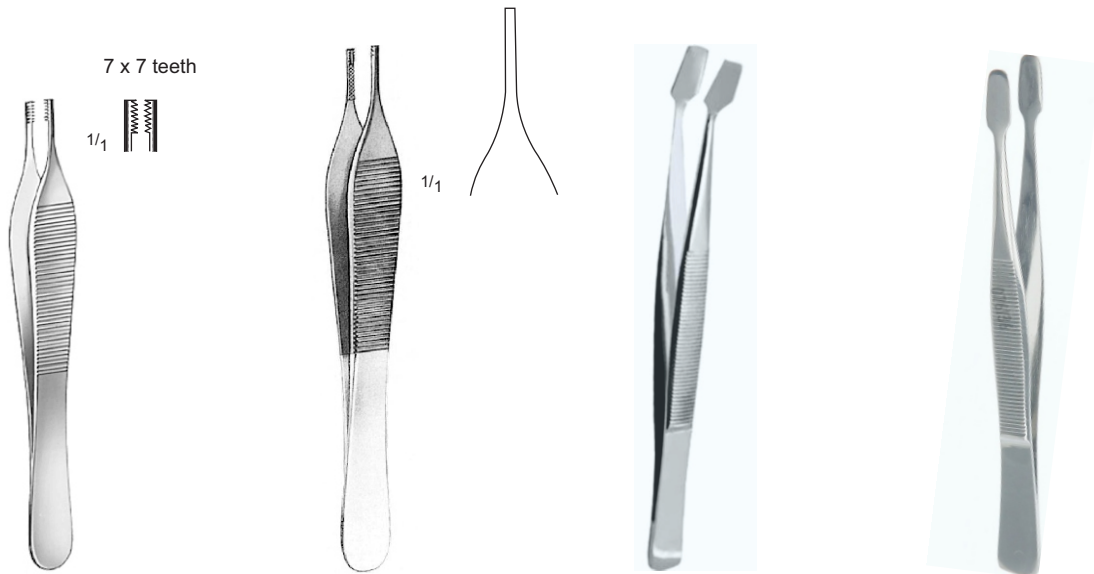

ADSON BROWN
 14-021-12
 12 cm / 4 3/4"

ADSON BROWN T/C
 14-121-62
 12 cm / 4 3/4"

KUEHNE,
 14-020-10
 10 cm

KUEHNE,
 14-220-12
 12 cm

Delicate Tissue Forceps, with Tungsten Carbide T/C Inserts

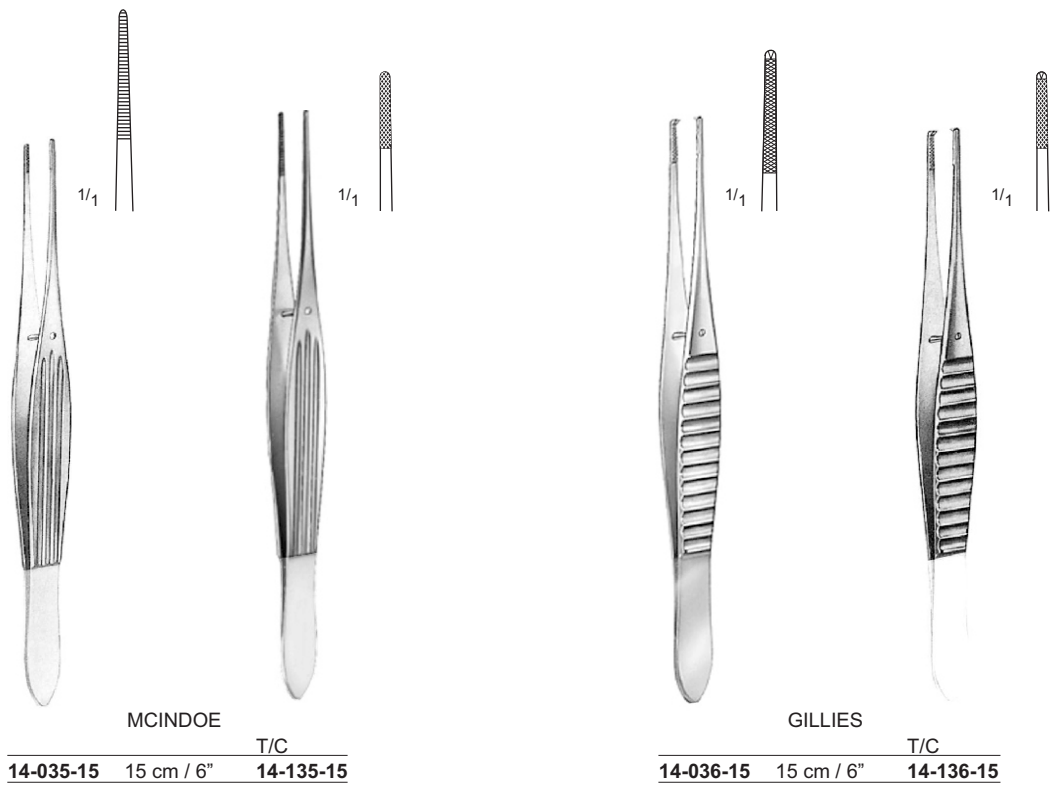
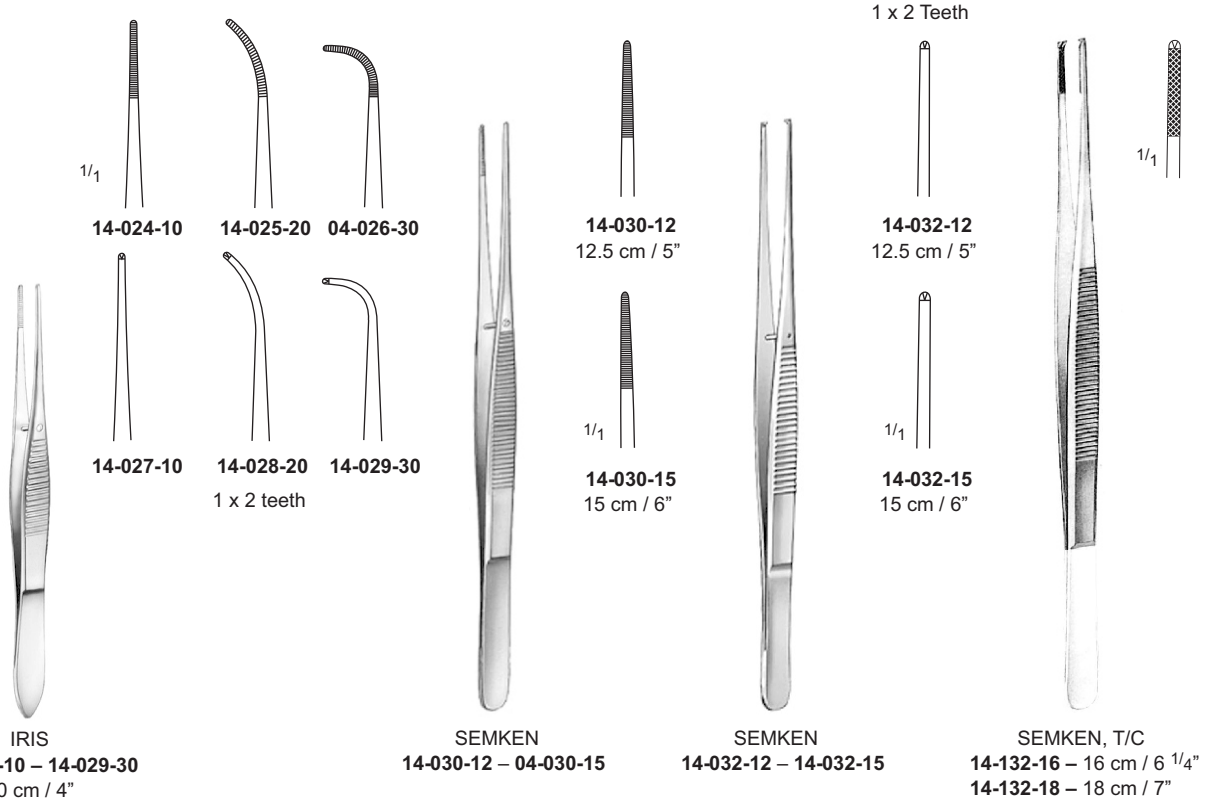

Tissue Forceps, with Tungsten Carbide T/C Inserts

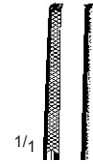
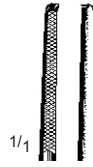

WAUGH
 1 x 2 teeth

T/C

15 cm / 6 " **14-037-15**
 20 cm / 8 " **14-037-20**

14-038-15
14-038-20

14-138-15
14-138-20

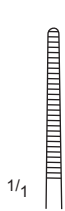

14-039-18
 18 cm / 7 "

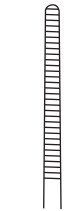

14-039-20
 20 cm / 8 "



14-039-25
 25 cm / 10 "



14-041-18
 18 cm / 7 "



14-041-20
 20 cm / 8 "



14-041-25
 25 cm / 10 "



14-139-18
 18 cm / 7 "



14-139-20
 20 cm / 8 "



14-139-25
 25 cm / 10 "

POTT SMITH
 14-039-18 – 14-039-25

POTT SMITH
 14-041-18 – 14-041-25
 1 x 2 teeth

POTT SMITH, T/C
 14-139-18 – 14-139-25

Atraumatic Vascular Forceps

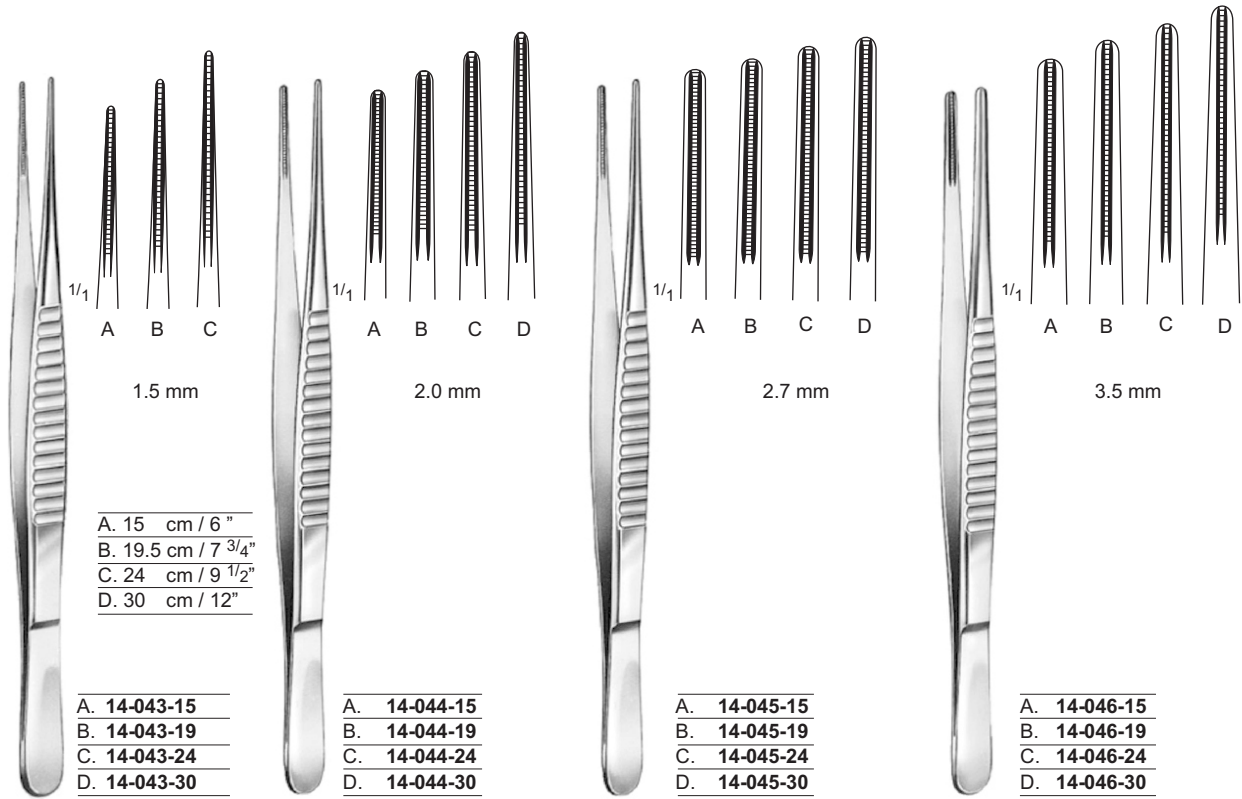

- A. 15 cm / 6"
- B. 19.5 cm / 7 3/4"
- C. 24 cm / 9 1/2"
- D. 30 cm / 12"

- A. 14-043-15
- B. 14-043-19
- C. 14-043-24
- D. 14-043-30

- A. 14-044-15
- B. 14-044-19
- C. 14-044-24
- D. 14-044-30

- A. 14-045-15
- B. 14-045-19
- C. 14-045-24
- D. 14-045-30

- A. 14-046-15
- B. 14-046-19
- C. 14-046-24
- D. 14-046-30

DE BACKEY

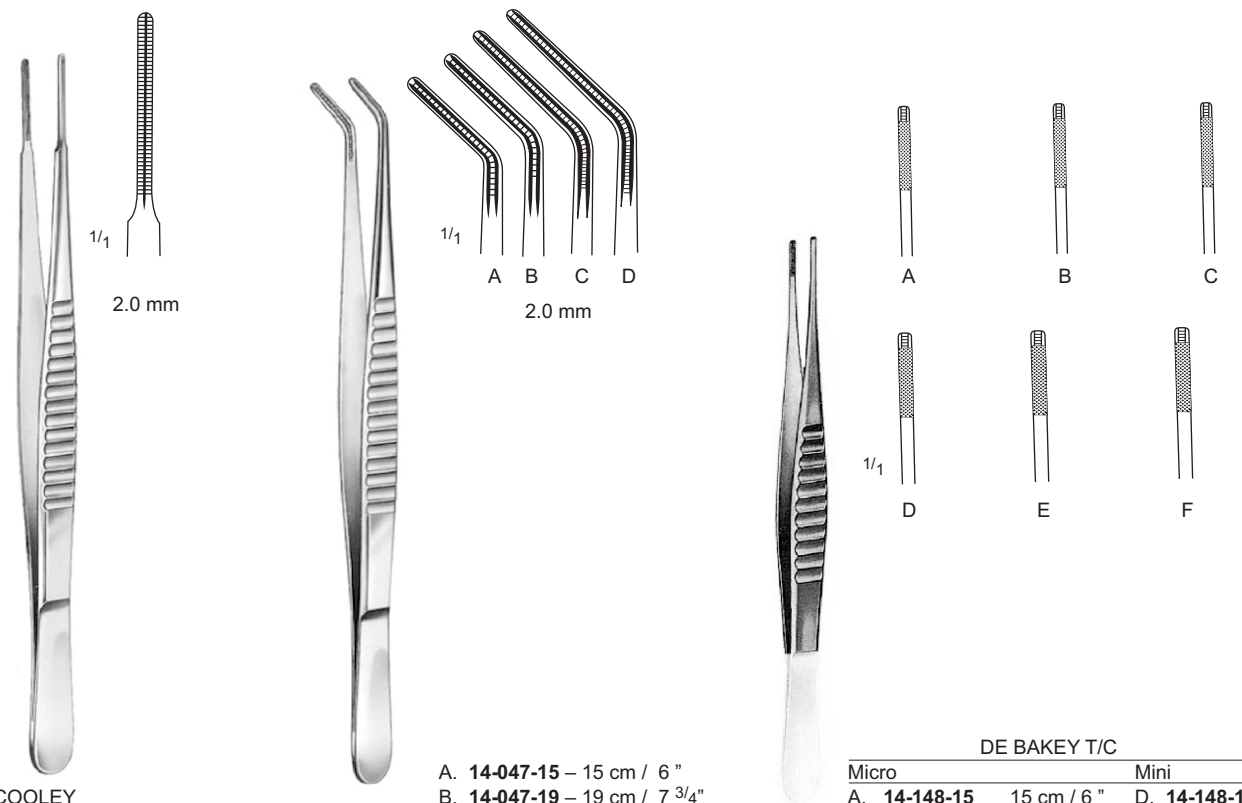

- COOLEY
 14-063-16 – 16 cm / 6 1/4"
 14-063-20 – 20 cm / 8"

- A. 14-047-15 – 15 cm / 6"
- B. 14-047-19 – 19 cm / 7 3/4"
- C. 14-047-24 – 24 cm / 9 1/2"
- D. 14-047-30 – 30 cm / 12"

DE BAKEY T/C			
	Micro		Mini
A.	14-148-15	15 cm / 6"	D. 14-148-15
B.	14-148-19	19.5 cm / 7 3/4"	E. 14-148-19
C.	14-148-24	24 cm / 9 1/2"	F. 14-148-24

Delicate Tissue Forceps, with Tungsten Carbide T/C Inserts

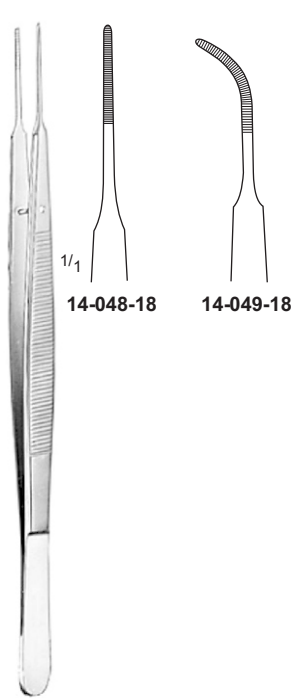

GEARLD
 14-048-18 – 14-049-18
 18 cm / 7"

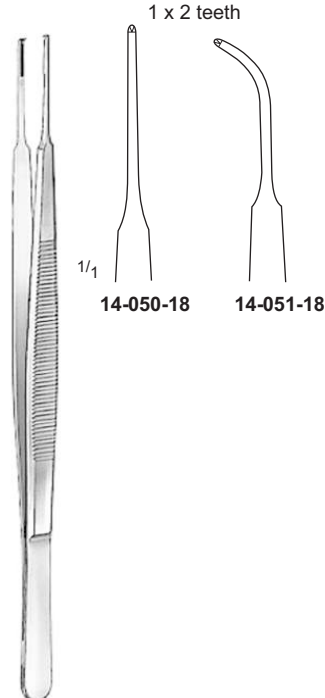

GEARLD
 14-050-18 – 14-051-18
 18 cm / 7"

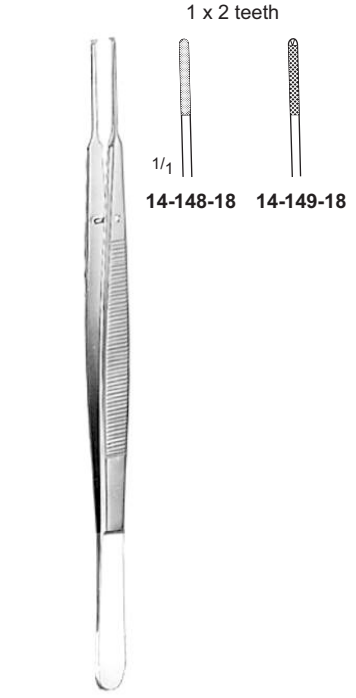

GEARLD, T/C
 14-148-18 – 14-149-18
 18 cm / 7"

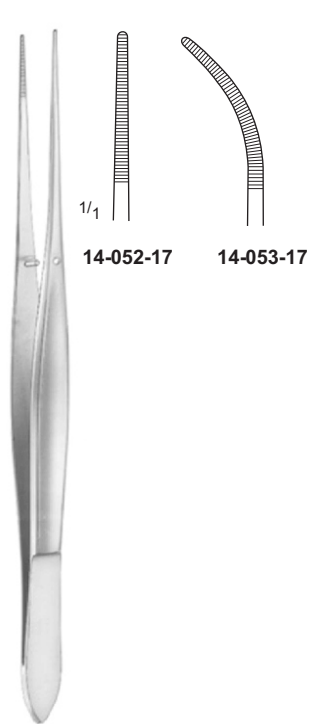

CUSHING
 14-052-17 – 14-053-17
 17.5 cm / 7"



CUSHING
 14-054-17
 17.5 cm / 7"

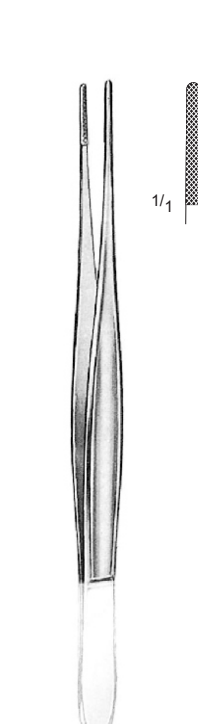

CUSHING T/C
 14-152-17
 17.5 cm / 7"

Tissue Grasping Forceps, with Tungsten Carbide T/C Inserts

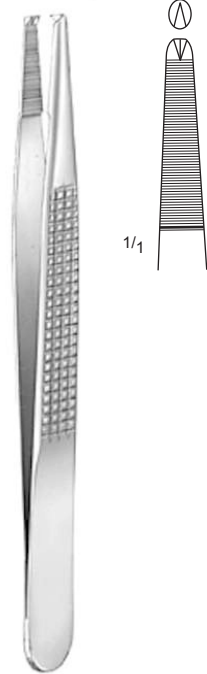

BONNEY
14-055-18
 18 cm / 7"

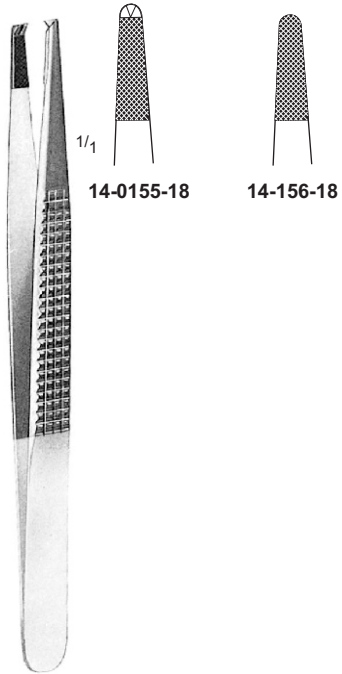

BONNEY T/C
14-155-18 – 14-156-18
 18 cm / 7"



TAYLOR
14-057-17
 17.5 cm / 7"



TAYLOR
14-058-17
 17.5 cm / 7"



TAYLOR
14-059-17
 17.5 cm / 7"



TAYLOR
14-060-17
 17.5 cm / 7"



TAYLOR
14-061-17
 17.5 cm / 7"



TAYLOR
14-062-17
 17.5 cm / 7"



TAYLOR, T/C
14-161-17
 17.5 cm / 7"

Tissue Grasping Forceps

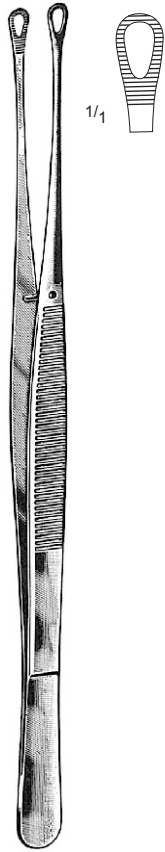

TUTTLE (SINGLEY)
 14-063-18 – 18 cm / 7"
 14-063-23 – 23 cm / 9"



RUSSIAN PATTERN
 14-064-15 – 14-064-25

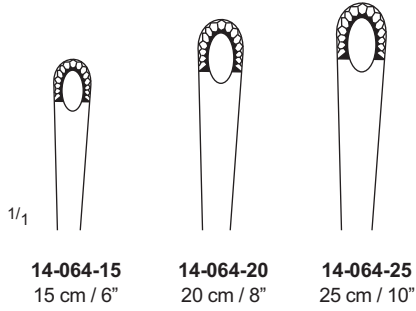

14-064-15
 15 cm / 6"

14-064-20
 20 cm / 8"

14-064-25
 25 cm / 10"

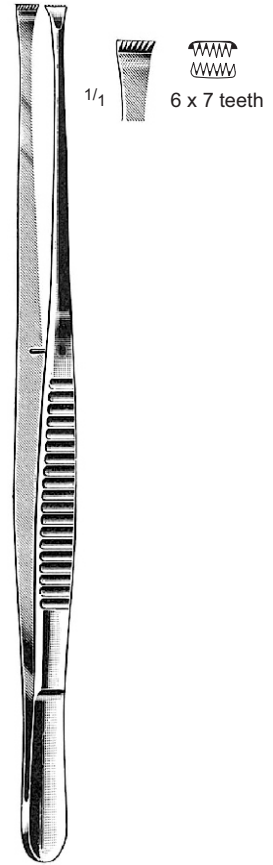

NELSON
 14-065-15 – 15 cm / 6"
 14-065-23 – 23 cm / 9"

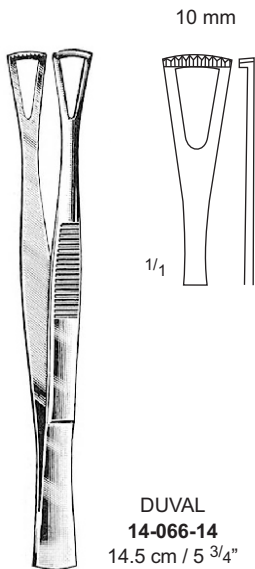

DUVAL
 14-066-14
 14.5 cm / 5 3/4"

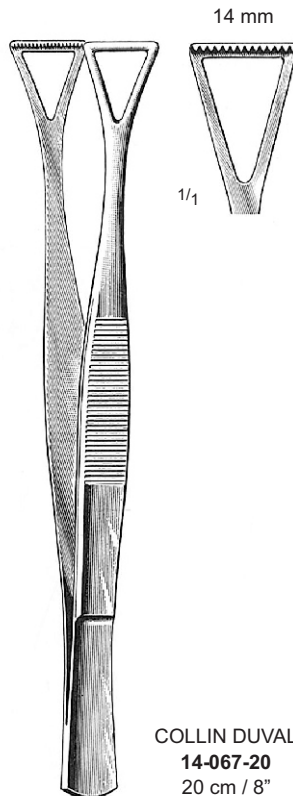

COLLIN DUVAL
 14-067-20
 20 cm / 8"

Ear and Nasal Dressing Forceps

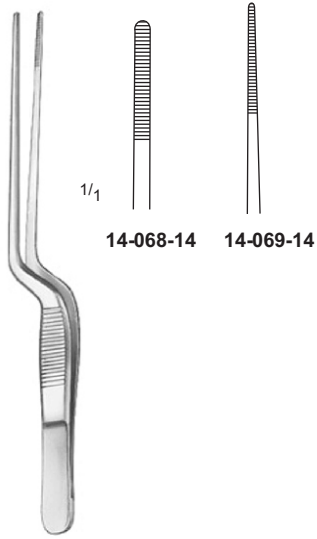

1/1
14-068-14 **14-069-14**

LUCAE
14-068-14 – 14-069-14
 14 cm / 5 1/2"

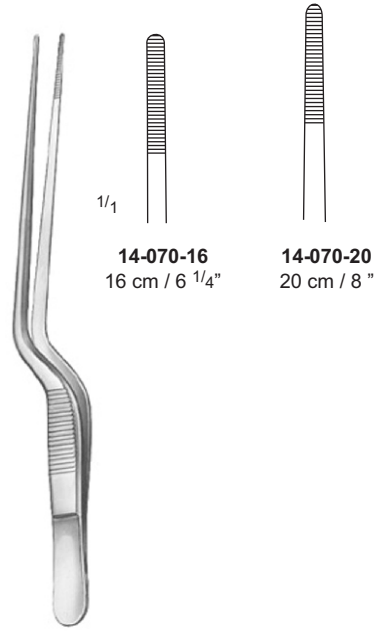

1/1
14-070-16 **14-070-20**
 16 cm / 6 1/4" 20 cm / 8"

GRUENWALD (JANSEN)
14-070-16 – 14-070-19

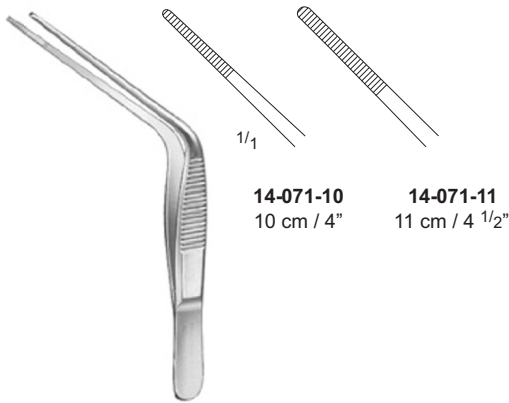

1/1
14-071-10 **14-071-11**
 10 cm / 4" 11 cm / 4 1/2"

TROELTSCH (WILDE)
14-071-10 – 14-071-11

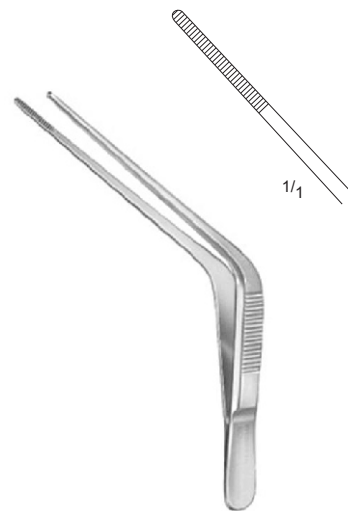

1/1
TROELTSCH (WILDE)
14-071-13
 13 cm / 5"

Delicate Pattern Forceps, Splinter Forceps

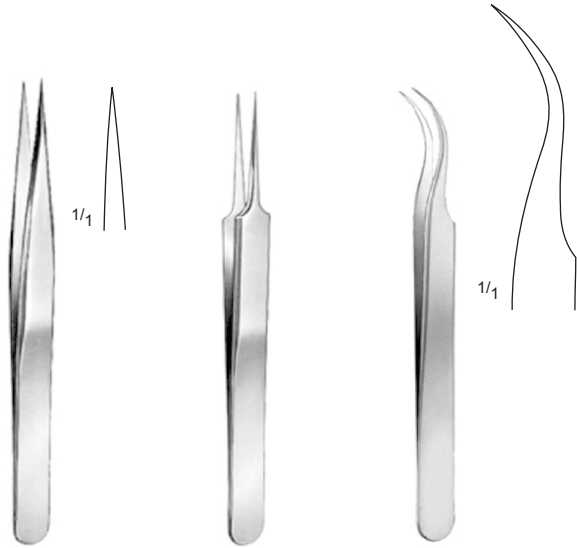

JEWELLER STYLE

14-079-03	14-081-05	14-082-07
No. 3	No. 5	No. 7
11.5 cm / 4 1/2"	11 cm / 4 1/4"	11.5 cm / 4 1/2"

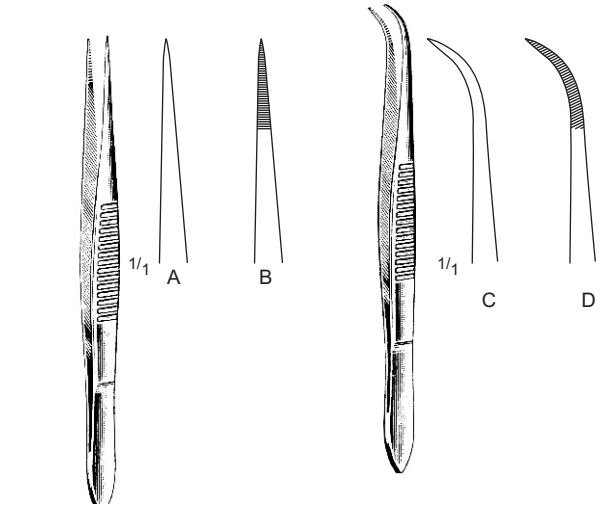

A	B		C	D
14-090-09	14-091-19	9 cm / 3 1/2"	14-092-09	14-093-19
14-090-11	14-091-21	11 cm / 4 1/2"	14-092-11	14-093-21
14-090-12	14-091-22	12.5cm / 5 "	14-092-12	14-093-22

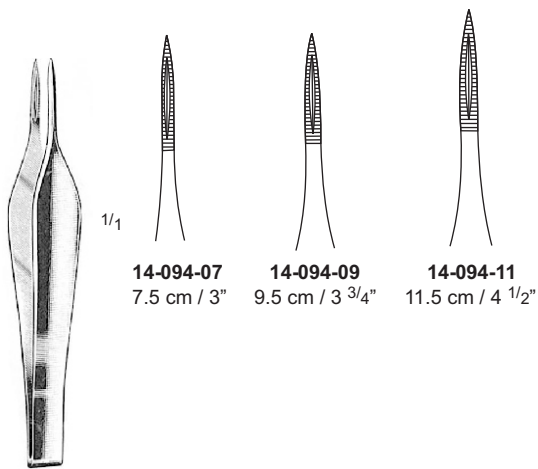

14-094-07 7.5 cm / 3"
14-094-09 9.5 cm / 3 3/4"
14-094-11 11.5 cm / 4 1/2"

FEILCHENFELD
 14-094-07 – 14-094-11

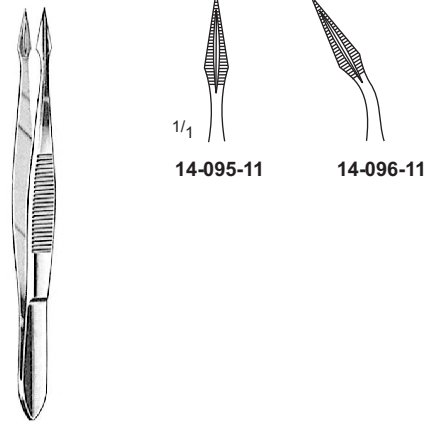

HUNTER
 14-095-11 – 14-096-11
 11 cm / 4 1/2"

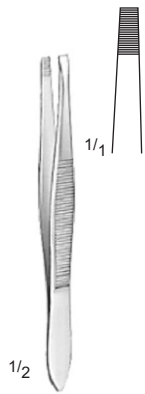

DOUGLAS
14-098-09
 9 cm / 3 1/2"

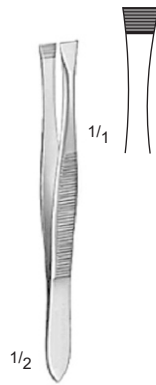

DOUGLAS
14-099-09
 9 cm / 3 1/2"

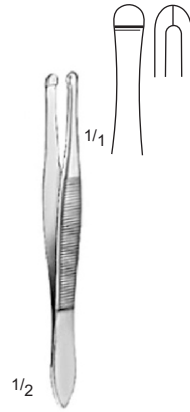

BEER
14-102-09
 9 cm / 3 1/2"



BARRAQUER
14-105-10
 10.5 cm / 4 1/4"



STEIGLITZ
14-188-14 – 14-189-14
 14 cm / 5 1/2"

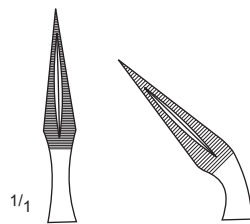

14-188-14

14-189-14



RALKS
14-190-14 – 14-191-4
 14.5 cm / 5 1/2"

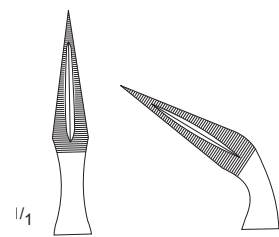

14-190-14

14-191-14

Micro Eye Forceps, Chalazion Forceps

