

Hemostatic Forceps



16

Bulldog Clamps



16-001-35
3.5 cm / 1 1/2"



16-002-35
3.5 cm / 1 1/2"



16-001-50
5 cm / 2"



16-002-50
5 cm / 2"

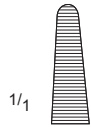

16-003-55
5.5 cm / 2 1/4"

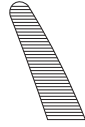

16-004-55
5.5 cm / 2 1/4"



DIEFFENBACH
16-001-35 – 16-004-55



JOHNS- HOPKINS
16-007-57 – 16-008-76



16-007-57
5.7 cm / 2 1/4"



16-007-63
6.3 cm / 2 1/2"

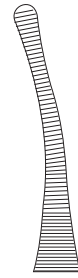

16-008-76
7.6 cm / 3"



DIETHRIC
16-005-08 – 16-005-22

1/1

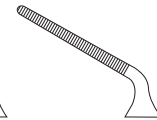
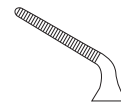

	16-005-08	16-005-10	16-005-12	16-005-18	16-005-20	16-005-22
Length	50 mm	50 mm	60 mm	50 mm	50 mm	60 mm
Jaws	8 mm	12 mm	20 mm	8 mm	12 mm	20 mm
Weight	3 gm	3 gm	3 gm	3 gm	3 gm	3 gm

Artery Forceps



HALSTEAD MOSQUITO
 16-010-12 – 16-019-14

16-010-12 12.5 cm / 5"	16-010-14 14 cm / 5 1/2"	16-011-12 12.5 cm / 5"	16-011-14 14 cm / 5 1/2"
16-018-12 12.5 cm / 5" 1 x 2 teeth	16-018-14 14 cm / 5 1/2" 1 x 2 teeth	16-019-12 12.5 cm / 5" 1 x 2 teeth	16-019-14 14 cm / 5 1/2" 1 x 2 teeth



MICRO- HALSTEAD MOSQUITO
 16-013-12 – 16-019-12

16-013-12 12.5 cm / 5"	16-014-12 12.5 cm / 5"
16-018-12 12.5 cm / 5" 1 x 2 teeth	16-019-12 12.5 cm / 5" 1 x 2 teeth

Artery Forceps



CHAPUT
 16-020-13
 13 cm / 5"



TUFFIER
 16-022-13
 13 cm / 5"

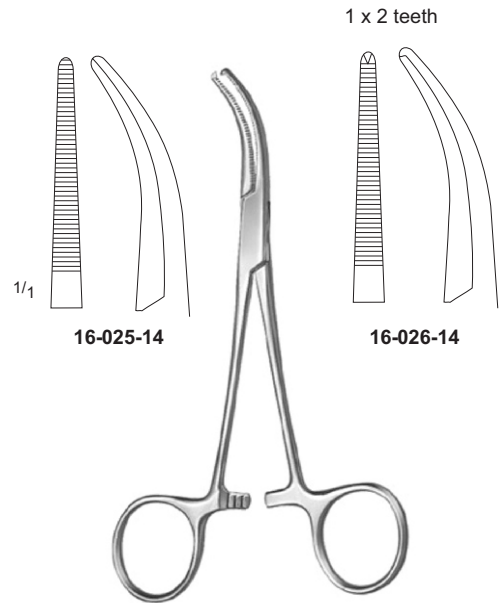

DANDY
 16-025-14 – 16-026-14
 14 cm / 5 1/2"

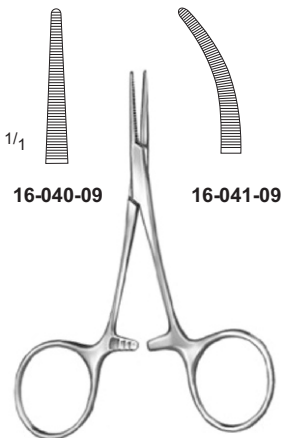

HARTMANN
 (BABY MOSQUITO)
 16-040-09 – 16-041-09
 9 cm / 3 1/2"

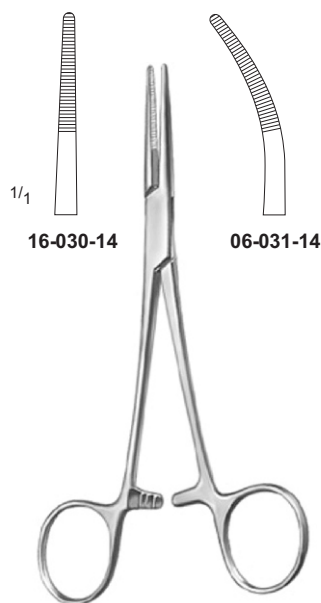

PROVIDENCE HOSPITAL
 16-030-14 – 16-031-14
 14 cm / 5 1/2"

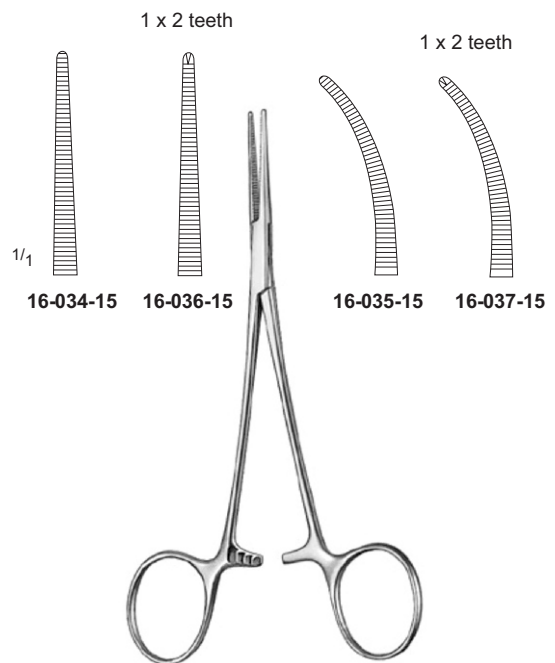

LERICHE
 16-034-15 – 16-037-15
 15 cm / 6"

Artery Forceps

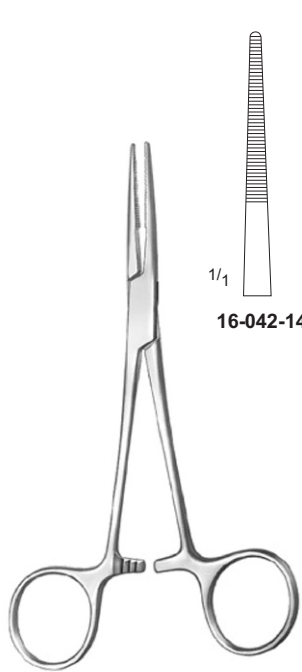

1/1

16-042-14

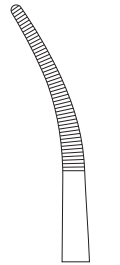

16-043-14

KELLY
 16-042-14 – 16-043-14
 14 cm / 5 1/2"

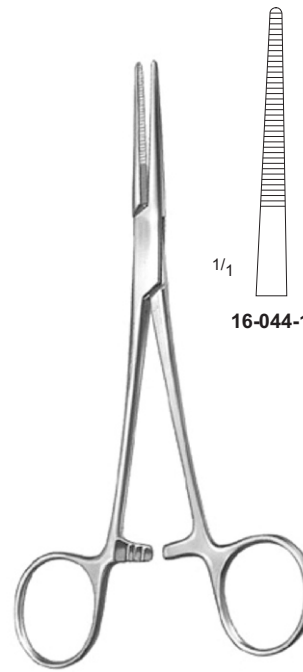

1/1

16-044-16

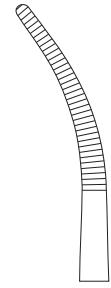

16-045-16

RANKIN-KELLY
 16-044-16 – 16-045-16
 16 cm / 6 1/4"

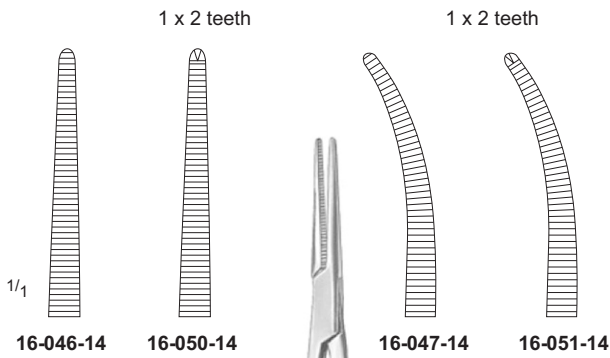

1 x 2 teeth

1 x 2 teeth

1/1

16-046-14

16-050-14

16-047-14

16-051-14

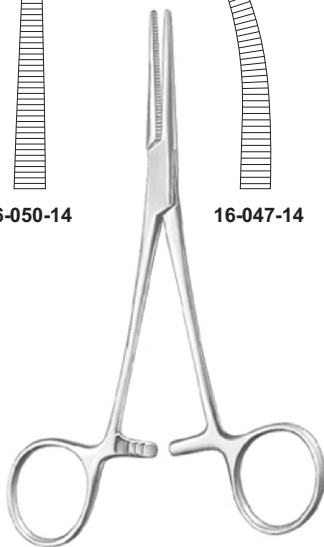

CRILE
 16-046-14 – 16-051-14
 14 cm / 5 1/2"

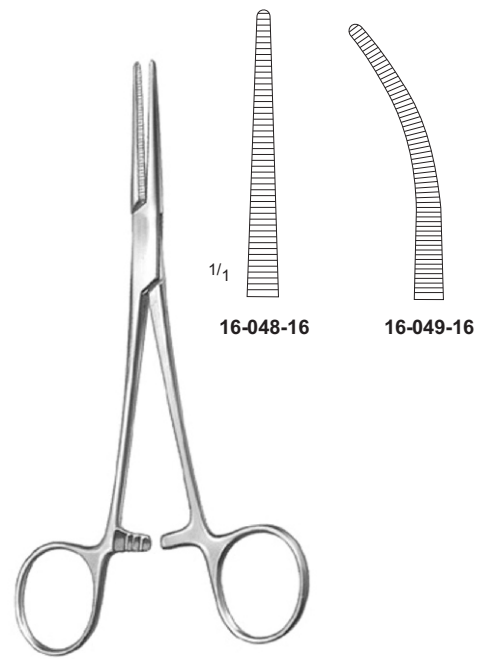

1/1

16-048-16

16-049-16

RANKIN-CRILE
 16-048-16 – 16-049-16
 16 cm / 6 1/4"

Artery Forceps

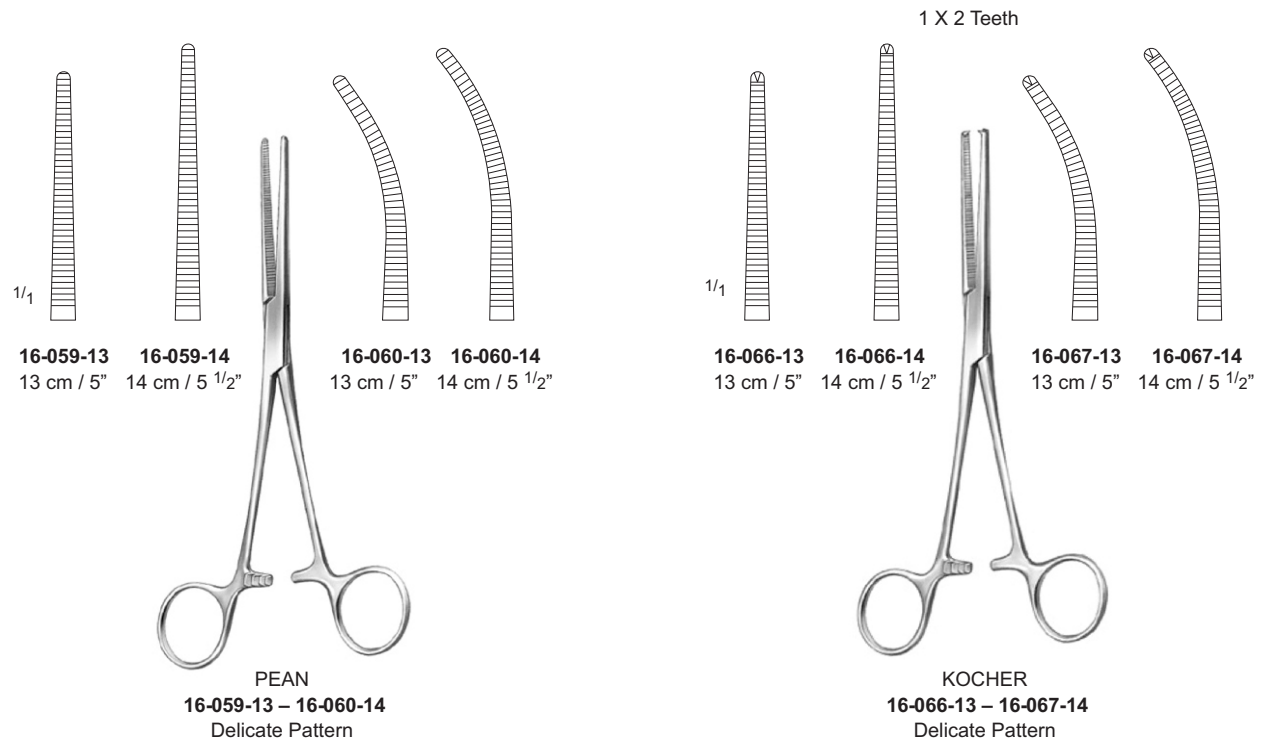
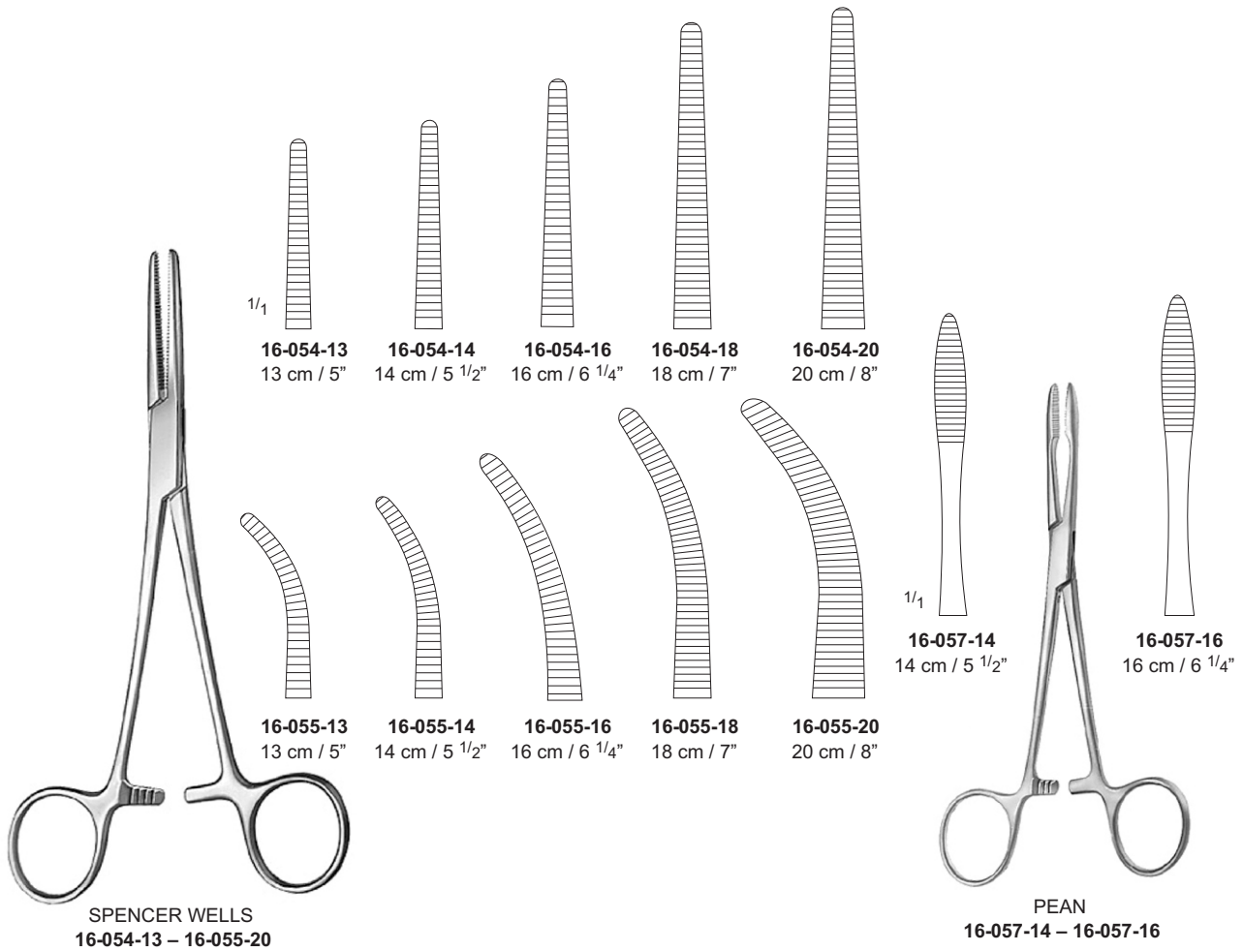

Artery Forceps

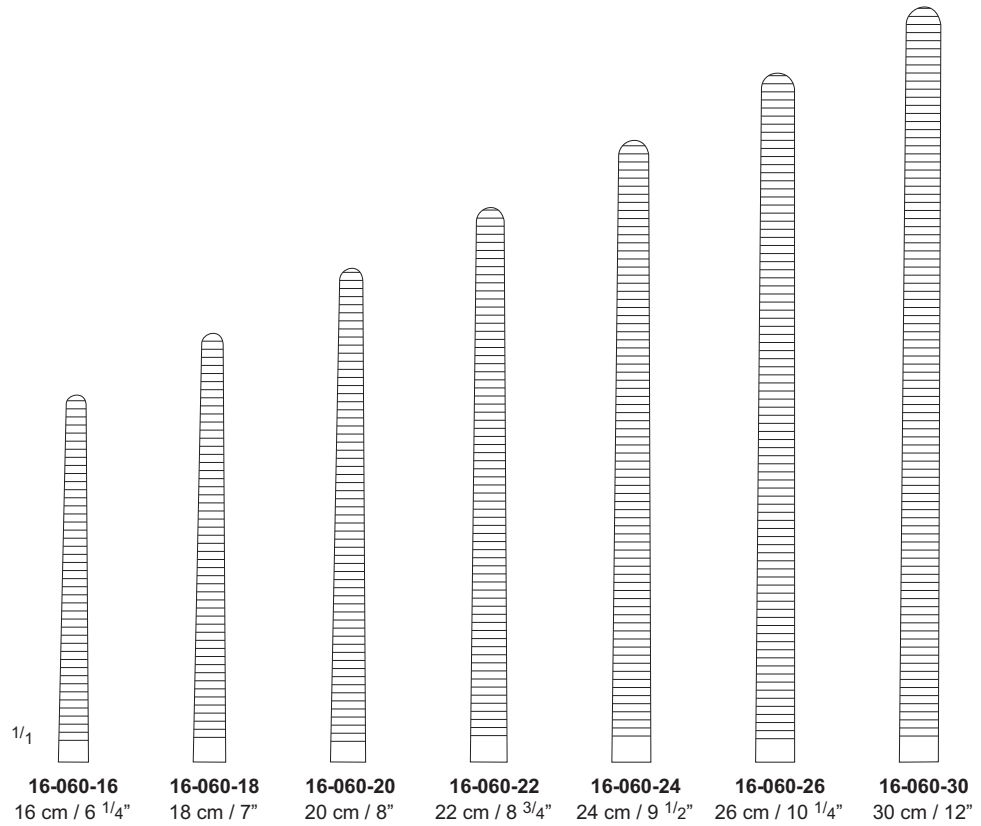

PEAN (ROCHESTER)
 16-060-16 – 16-060-30
 16-056-16 – 16-056-30

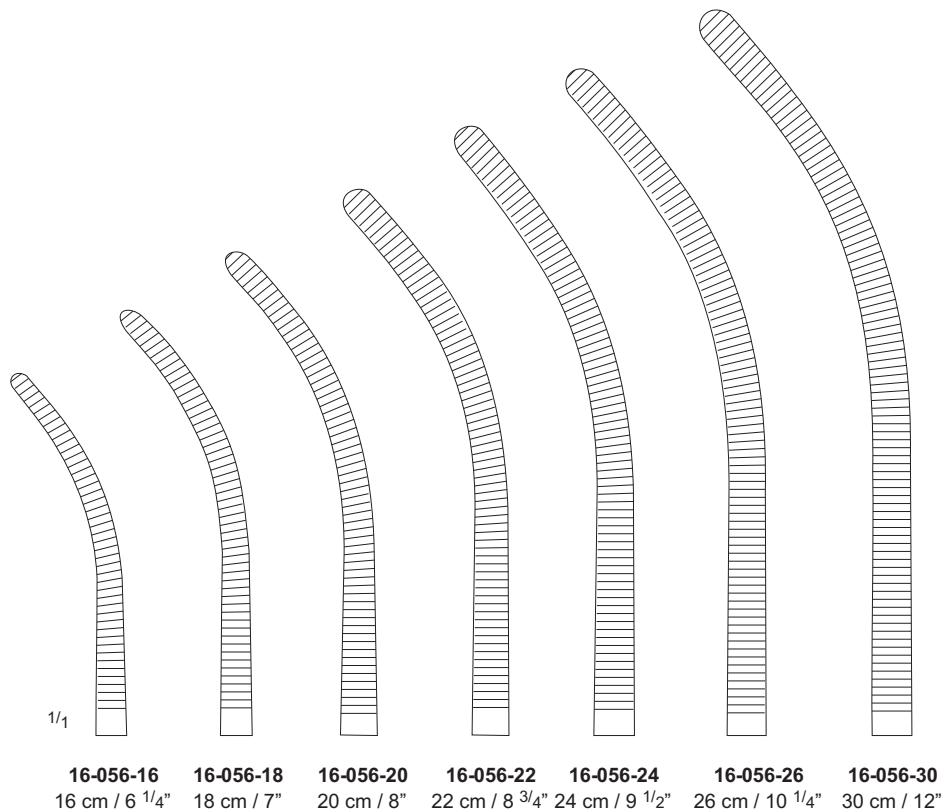

Artery Forceps

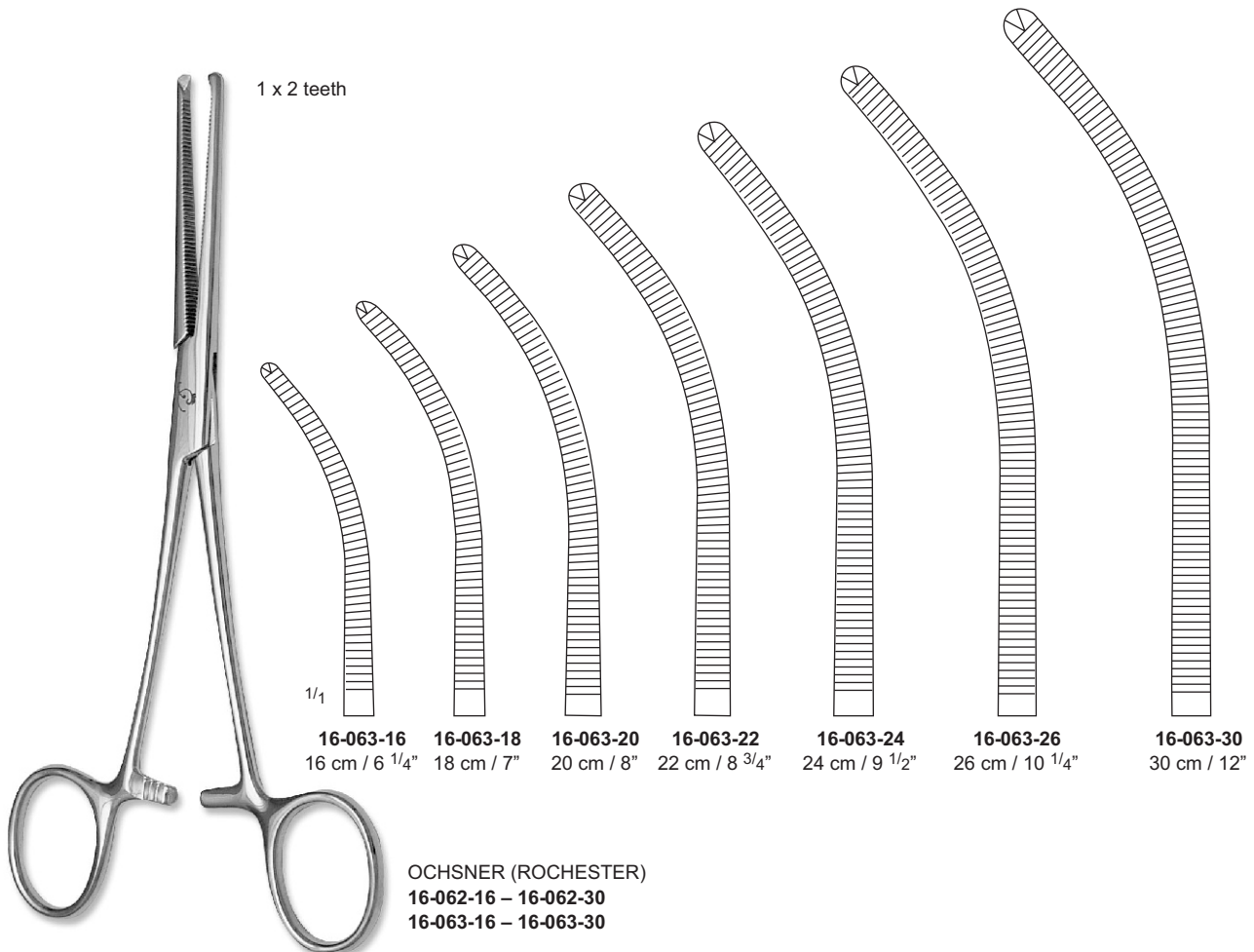
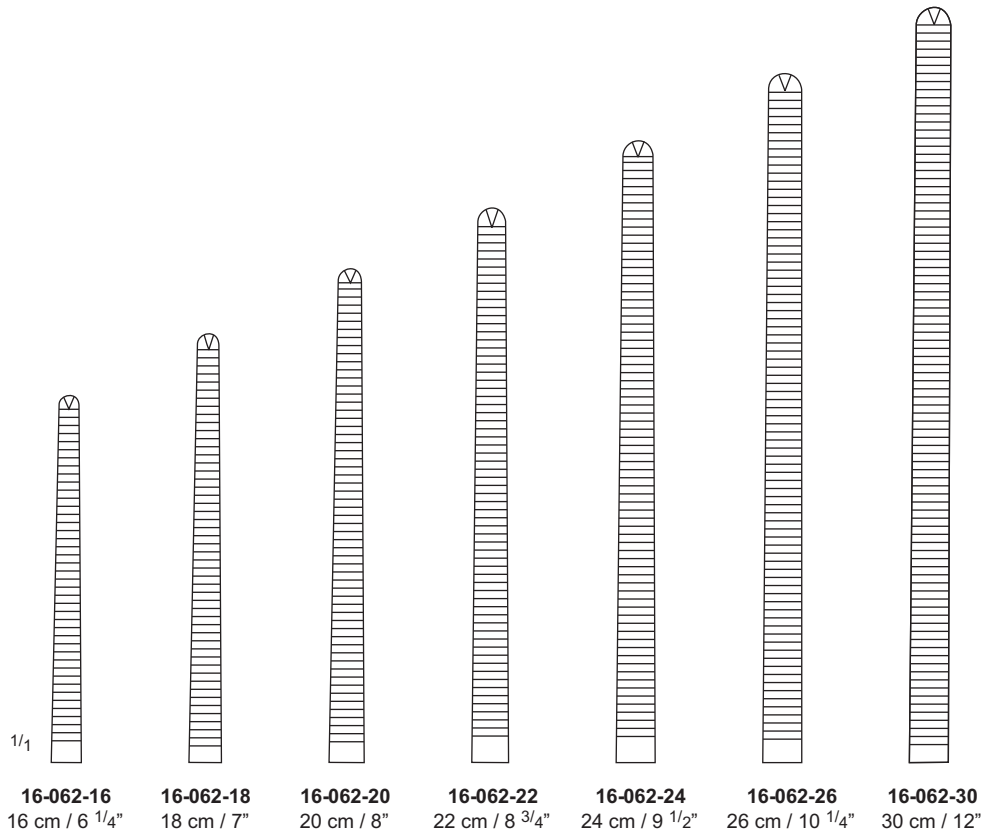

Artery Forceps

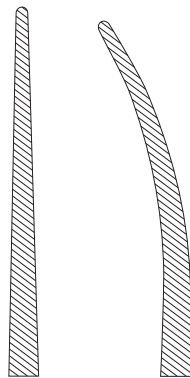

16-064-20 16-065-20
 20 cm / 8"

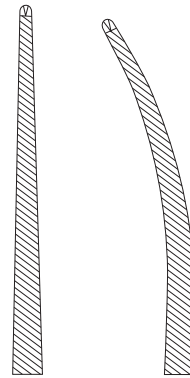

16-066-20 16-067-20
 20 cm / 8"
 1x2 teeth

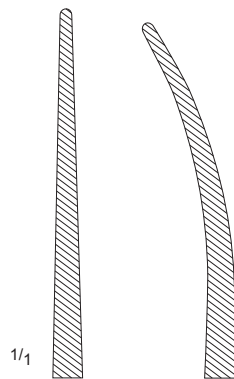

16-064-26 16-065-26
 26 cm / 10 1/4"

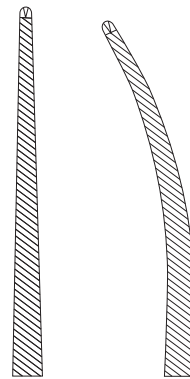

16-066-26 16-067-26
 26 cm / 10 1/4"
 1x2 teeth



BENGOLEA
 16-064-20 – 16-065-27

Artery Forceps, Dissecting & Ligature Forceps

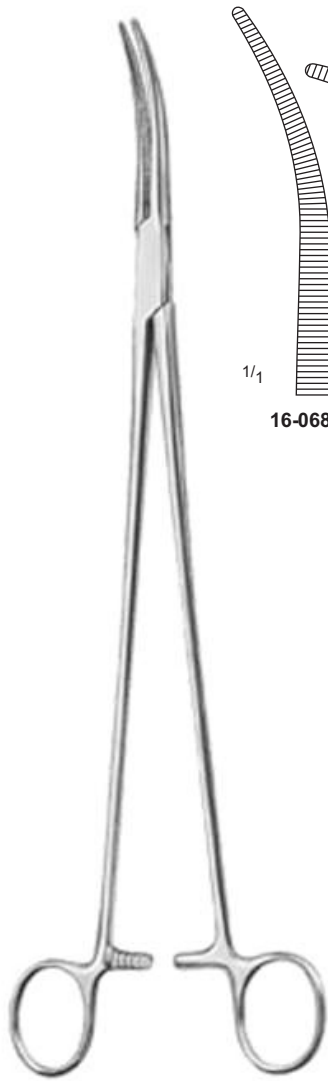

ZENKER
16-068-29 – 16-068-30
29.5 cm / 11 1/2"

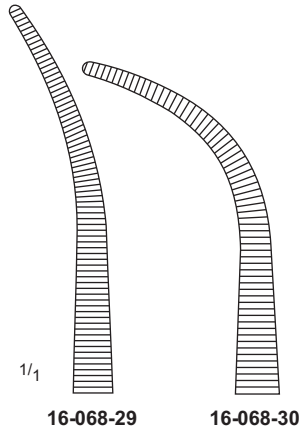

16-068-29

16-068-30

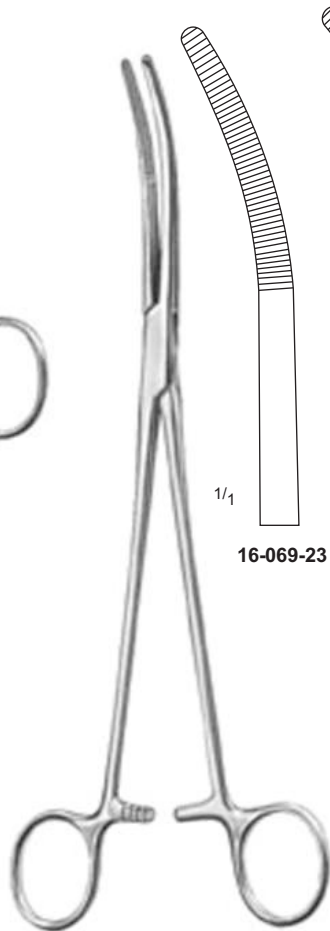

RUMEL
16-069-23 – 16-073-23
23 cm / 9"

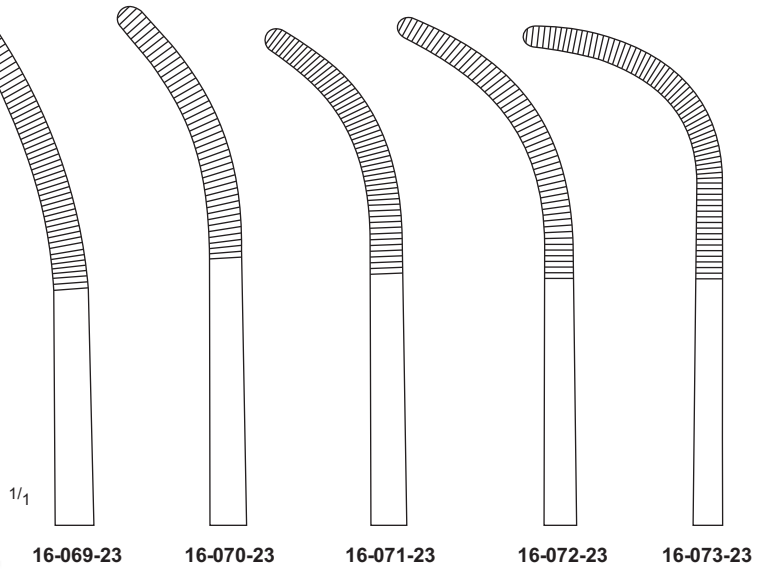

16-069-23

16-070-23

16-071-23

16-072-23

16-073-23

Artery Forceps, Hysterectomy and Vaginal Clamp Forceps

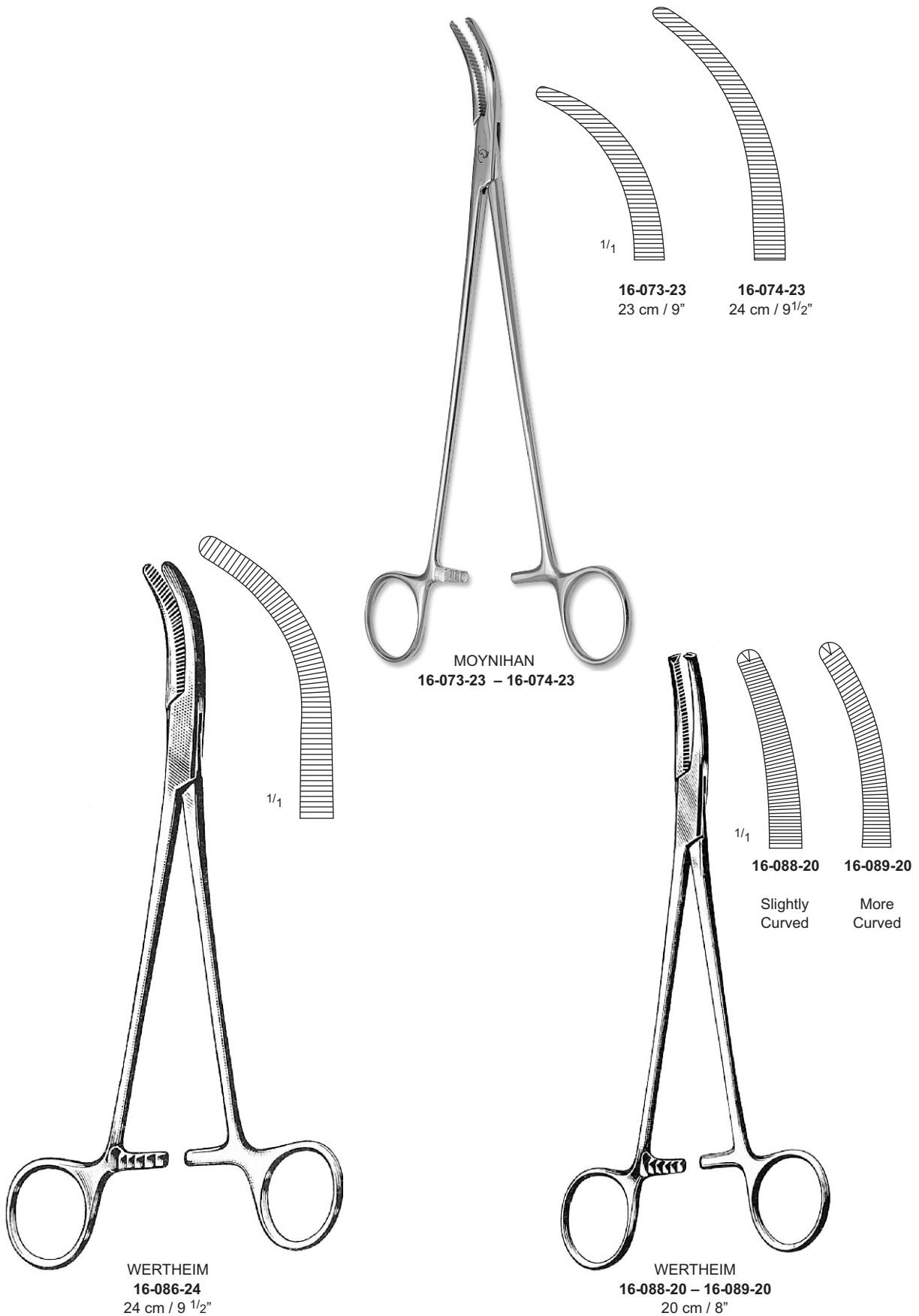

Artery Forceps, Clamps

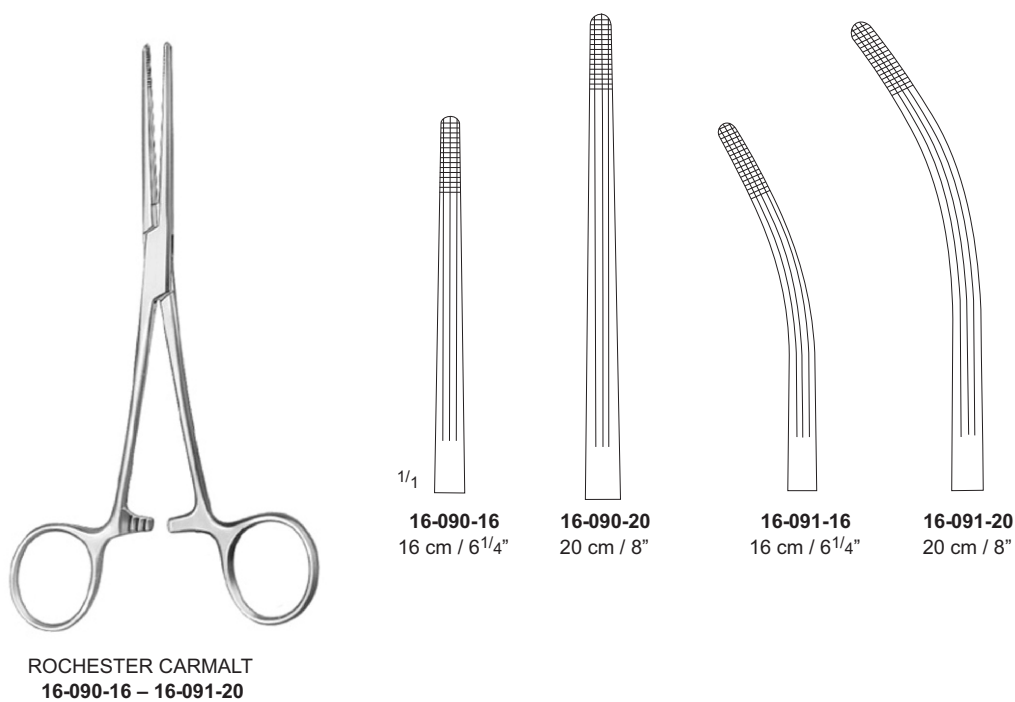
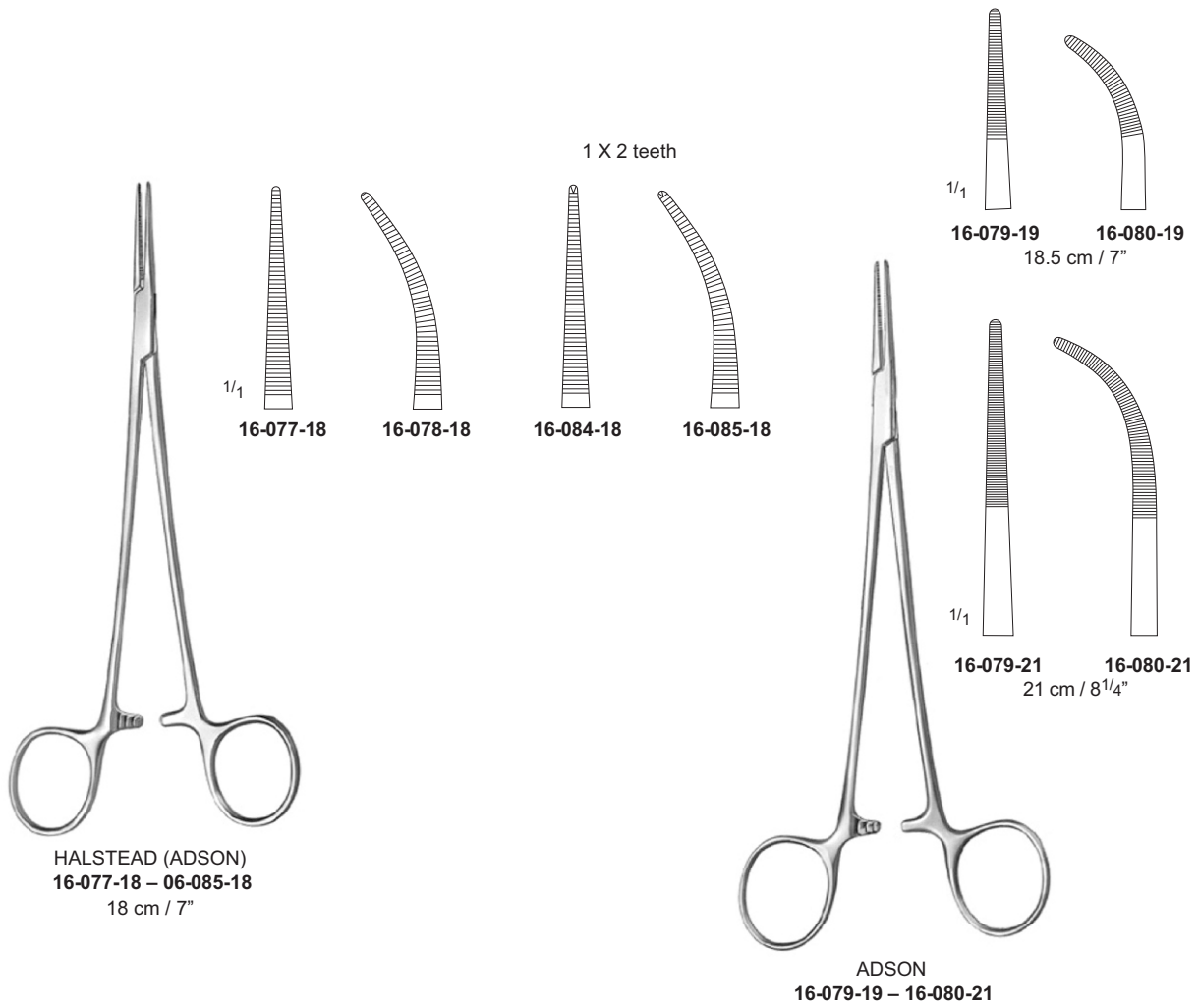

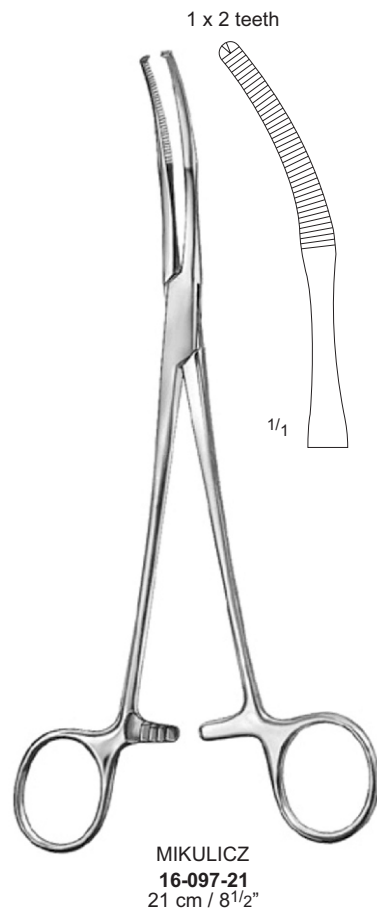
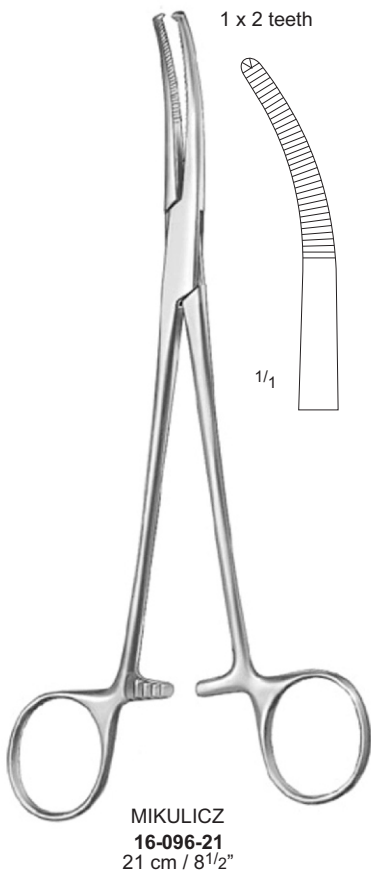
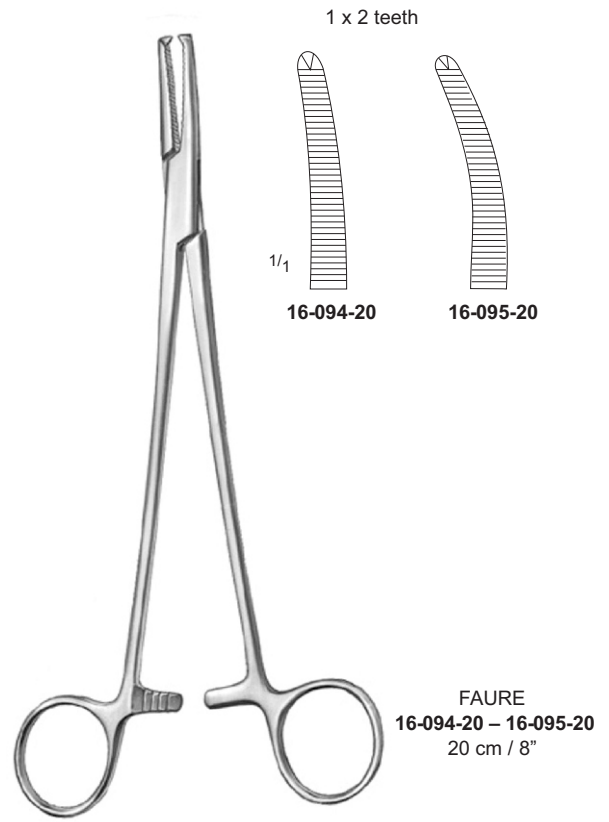
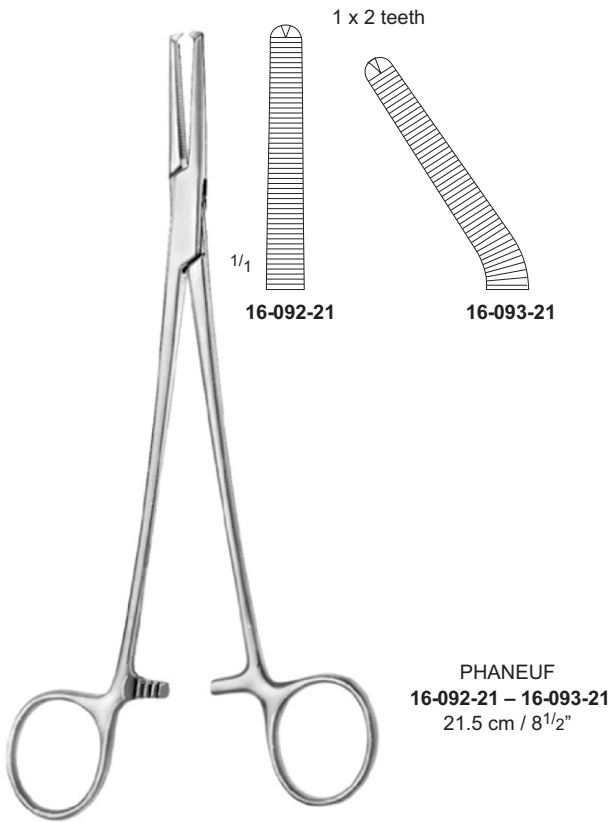

Artery Forceps, Dissecting and Ligature Forceps

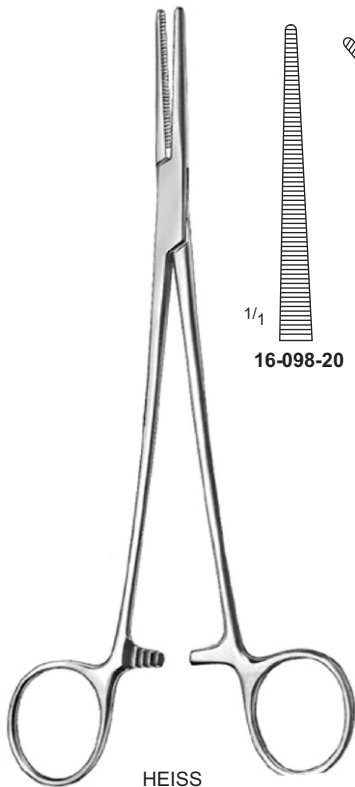

HEISS
 16-098-20 – 16-100-20
 20 cm / 8"

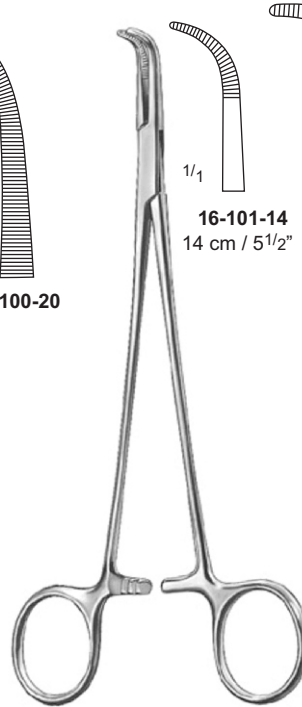
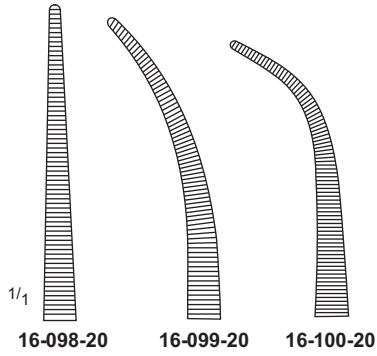

ADSON BABY
 16-101-14 – 16-102-19

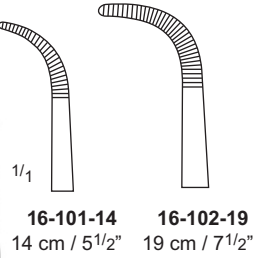

MIXTER BABY
 16-104-19
 19 cm / 7 1/2"

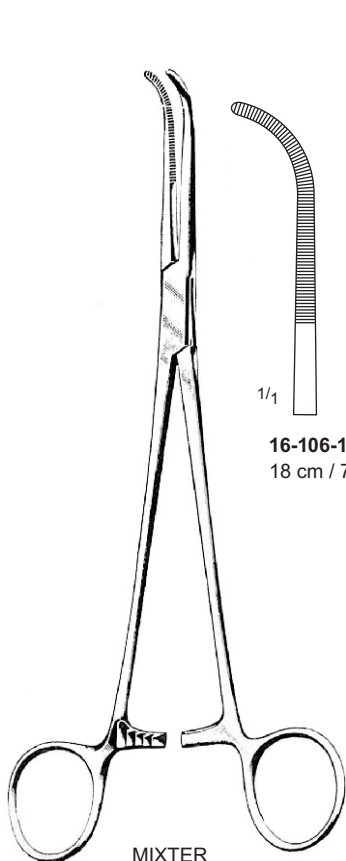

MIXTER
 16-106-18 – 16-106-23

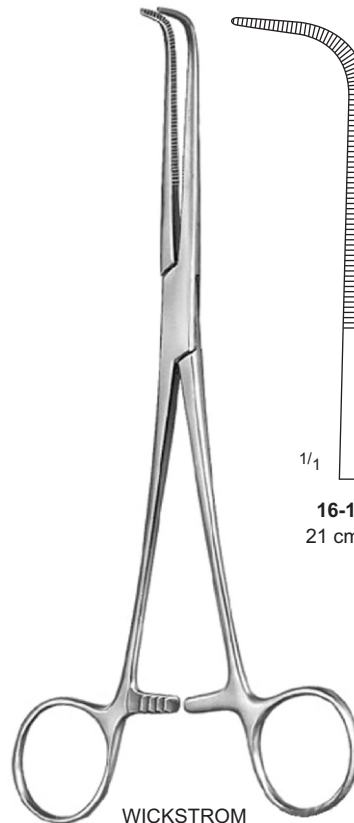
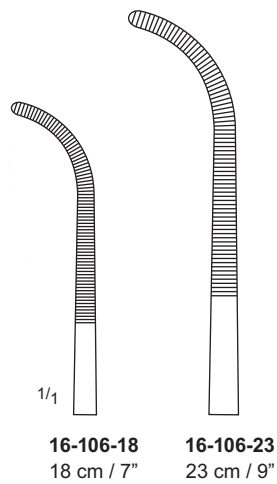

WICKSTROM
 16-107-81 – 16-107-24

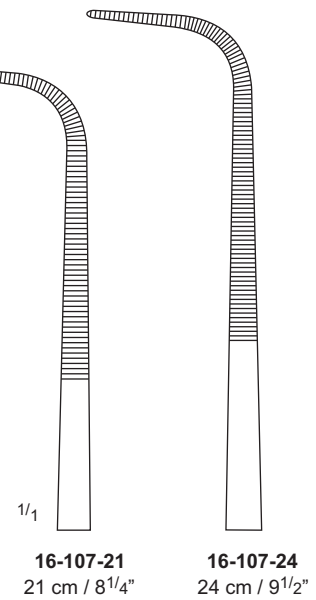

Artery Forceps, Dissecting and Ligature Forceps, Bronchus and Gall Duct Clamps

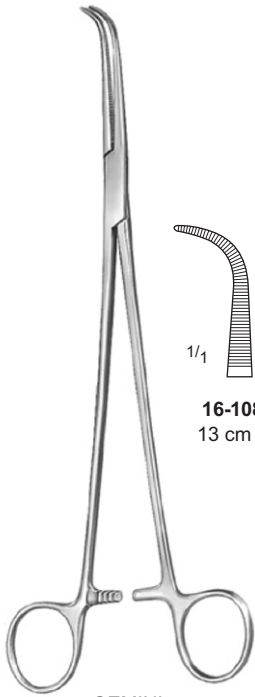

GEMINI
 16-108-13 – 16-108-28

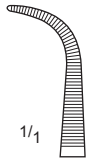

16-108-13
 13 cm / 5"

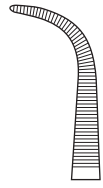

16-108-14
 14 cm / 5 1/2"

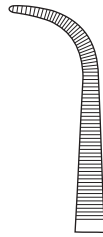

16-108-18
 18 cm / 7"



16-108-20
 20 cm / 8"



16-108-23
 23 cm / 9"



16-108-25
 25 cm / 10"

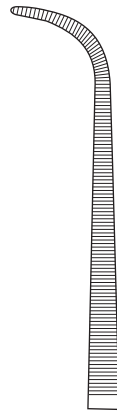

16-108-28
 28 cm / 11"



16-109-19

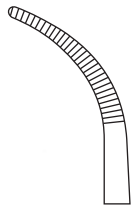

16-110-19



SCHNIDT
 16-111-19 – 16-111-18
 19 cm / 7 1/2"

Tonsil Seizing
 Forceps

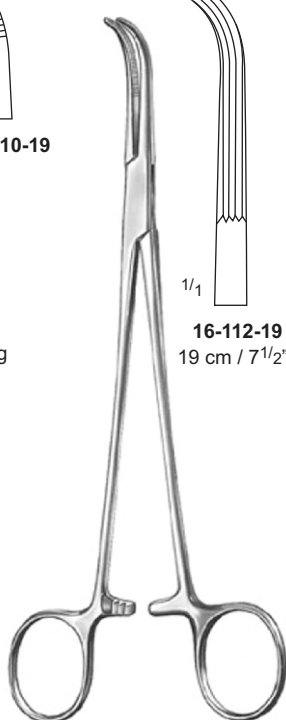

LAHEY



16-112-19
 19 cm / 7 1/2"

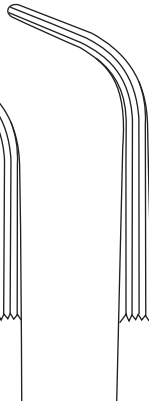

16-112-23
 23 cm / 9"

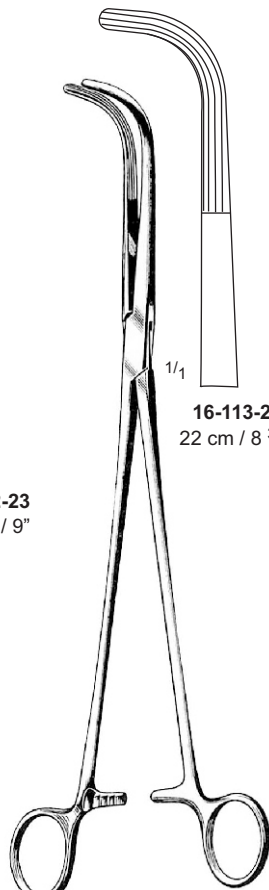

MIXTER
 16-113-22 – 16-113-27



16-113-22
 22 cm / 8 3/4"

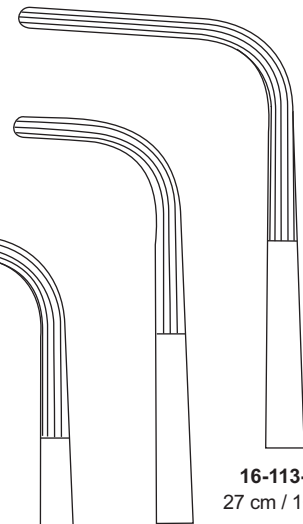

16-113-25
 25 cm / 10"

16-113-27
 27 cm / 10 3/4"

Tissue and Organ Holding Forceps

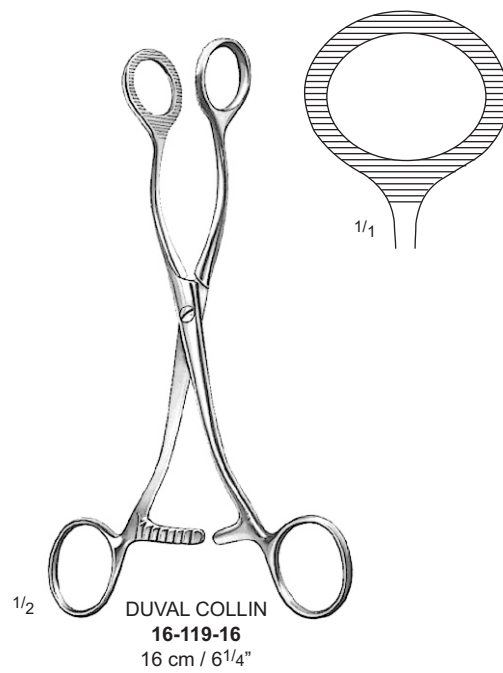
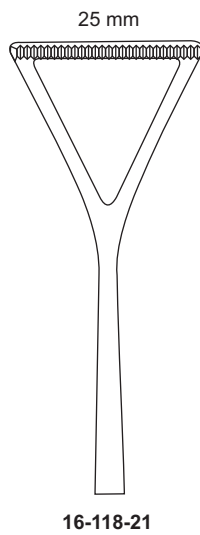
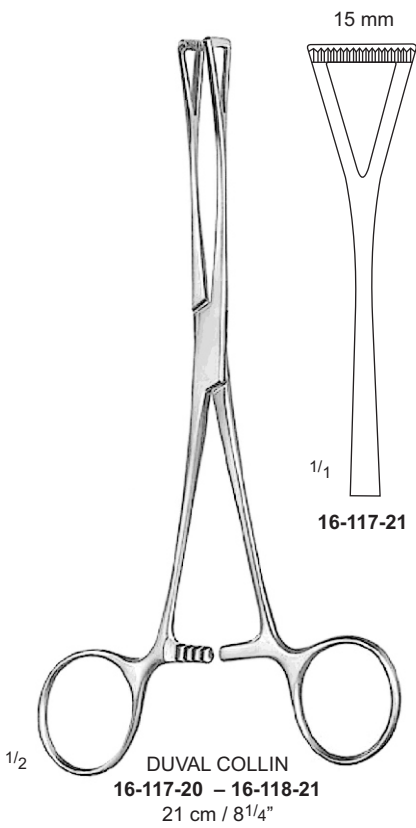
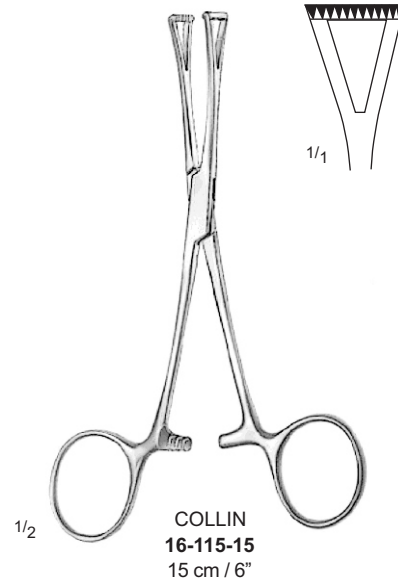
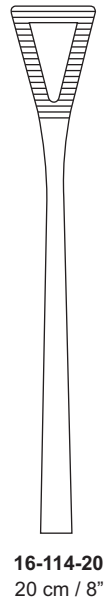
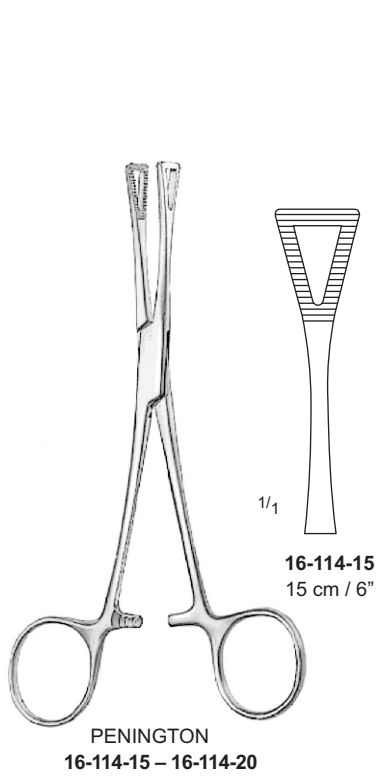

Towel Clamps



JONES
16-120-09
9 cm / 3 1/2"



SCHAEDEL
16-121-09
9 cm / 3 1/2"



BACKHAUS
16-125-09 – 09 cm / 3 1/4"
16-125-11 – 11 cm / 4 1/4"
16-125-13 – 13 cm / 5"
16-125-15 – 15 cm / 6"



BACKHAUS-ROEDER
16-128-13 – 13 cm / 5"
16-128-15 – 15 cm / 6"



BALL & SOCKET
16-130-13 – 13 cm / 5"
16-130-15 – 15 cm / 6"



LANE
16-133-15 – 15 cm / 6"
16-133-18 – 18 cm / 7"
16-133-20 – 20 cm / 8"

Tubing Clamps

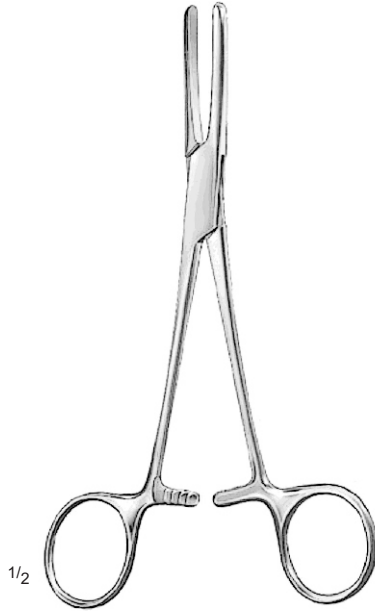

1/2

PRESBYTERIAN HOSPITAL
 16-134-16 – 16-134-20



1/1

16-134-16
 16 cm / 6 1/4"



16-134-18
 18 cm / 7"



16-134-20
 20 cm / 8"

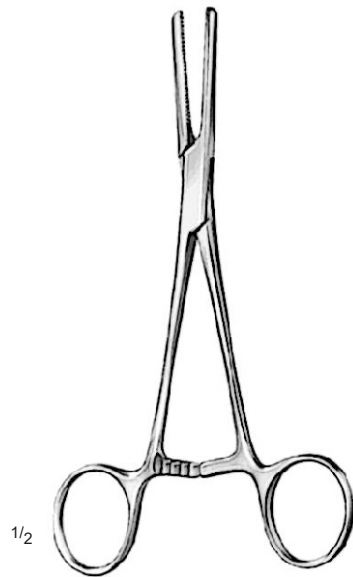

1/2

SCHOENBERG
 16-135-16 – 16-135-20

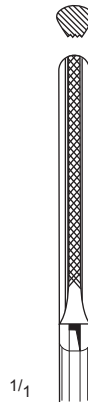

1/1

16-135-16
 16 cm / 6 1/4"



16-135-18
 18 cm / 7"



16-135-20
 20 cm / 8"