

Intestinal Rectal

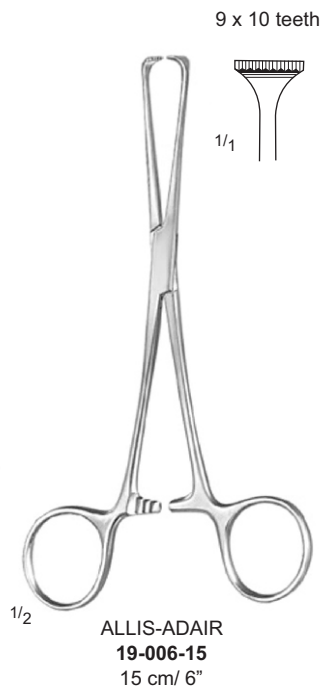

Tissue Holding Forceps

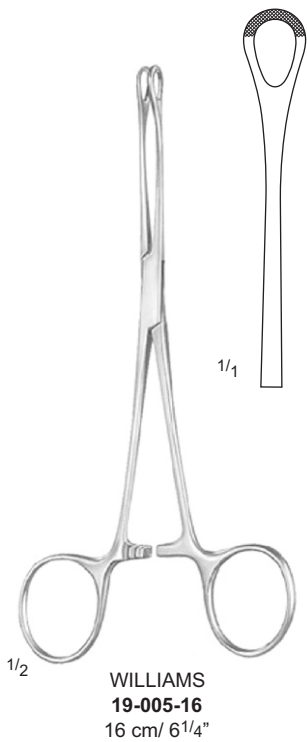
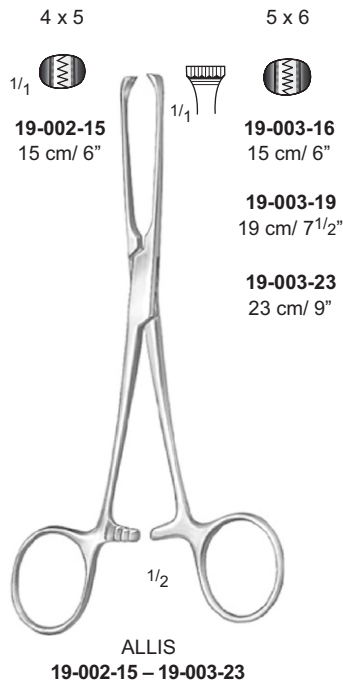

Tissue Holding Forceps

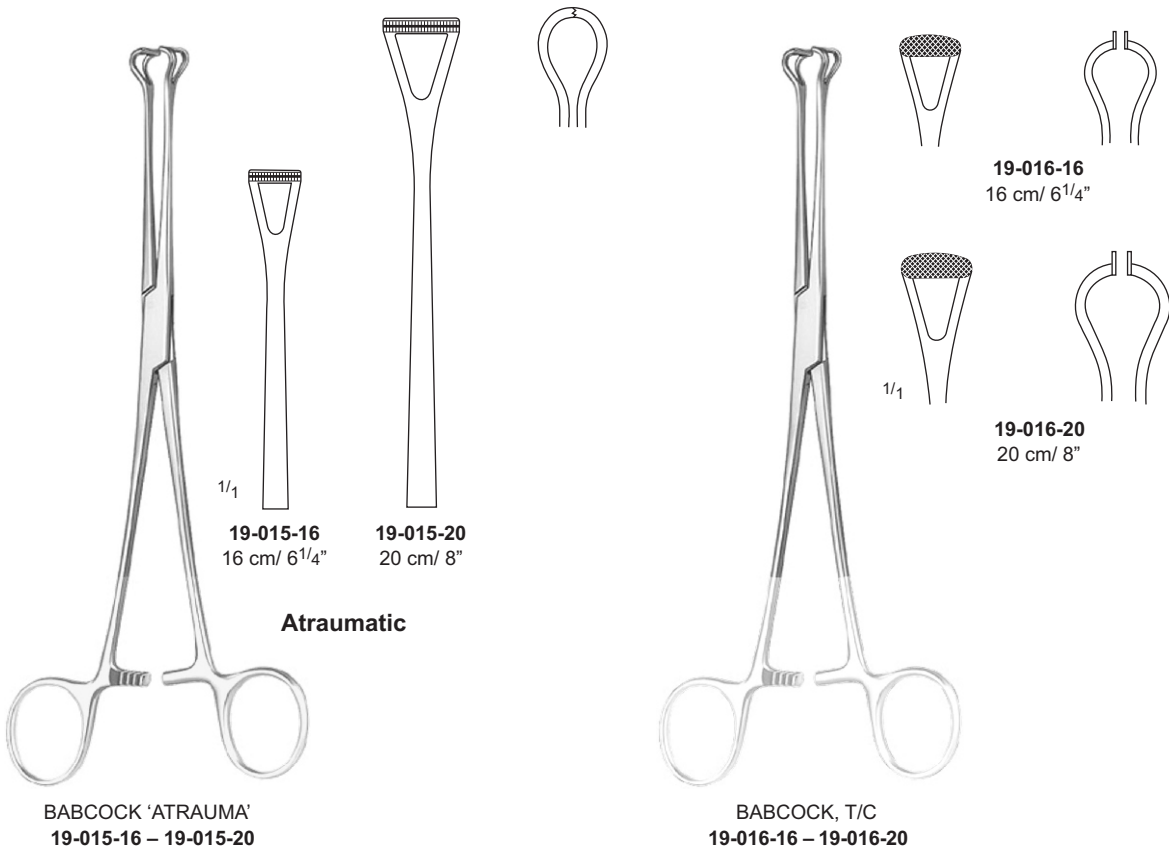
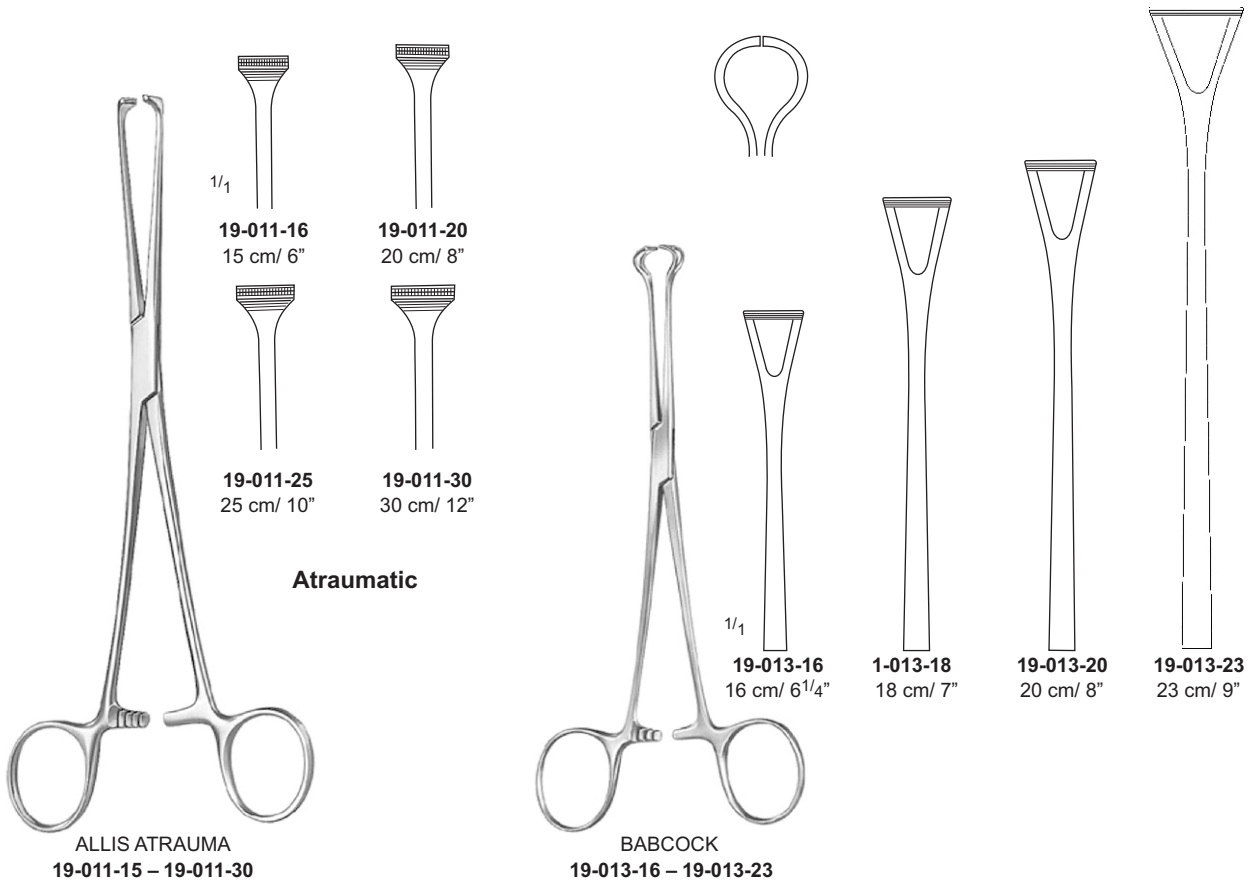

Intestinal Clamp Forceps

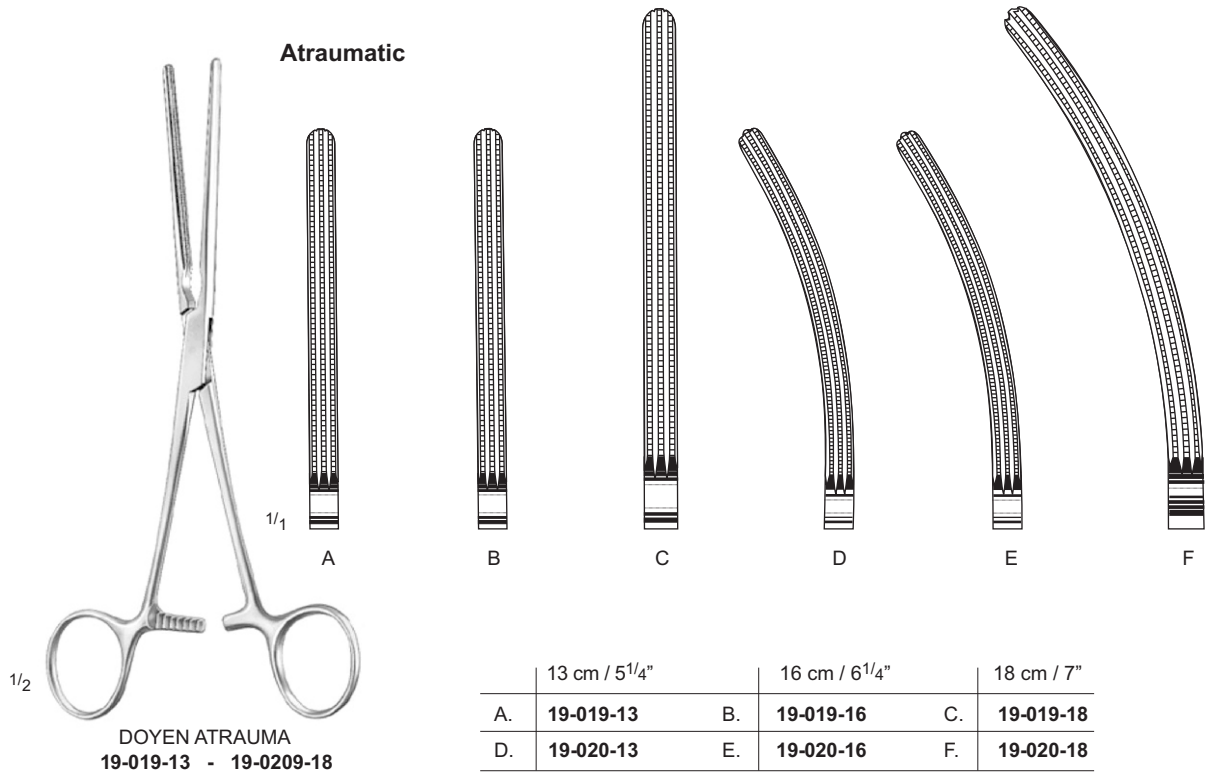
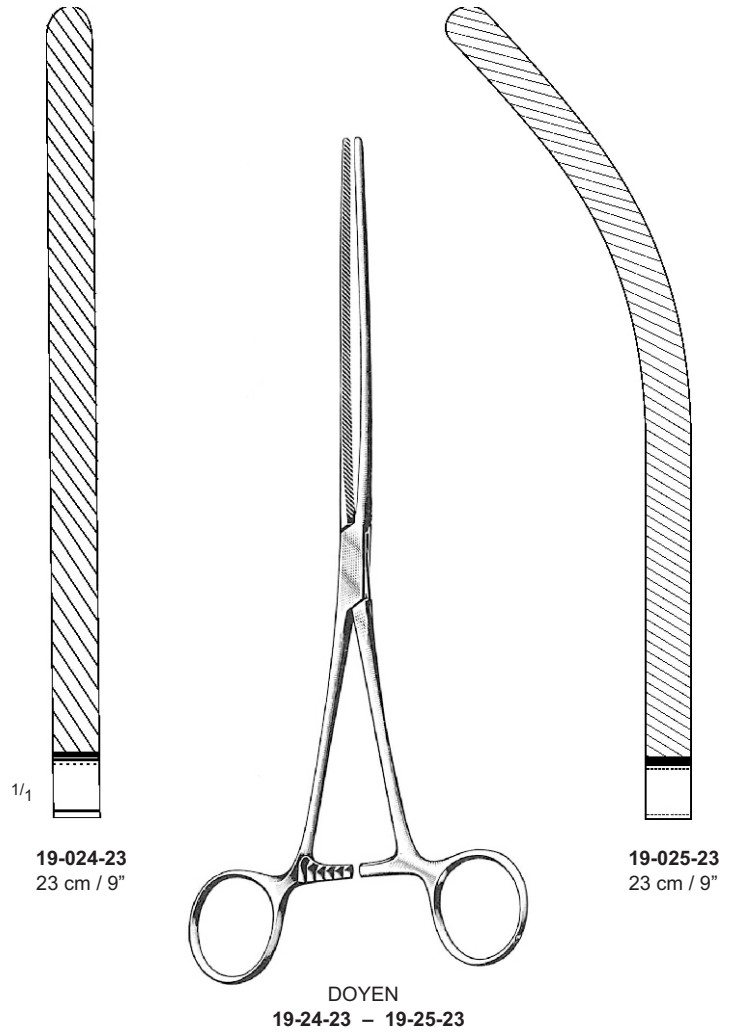
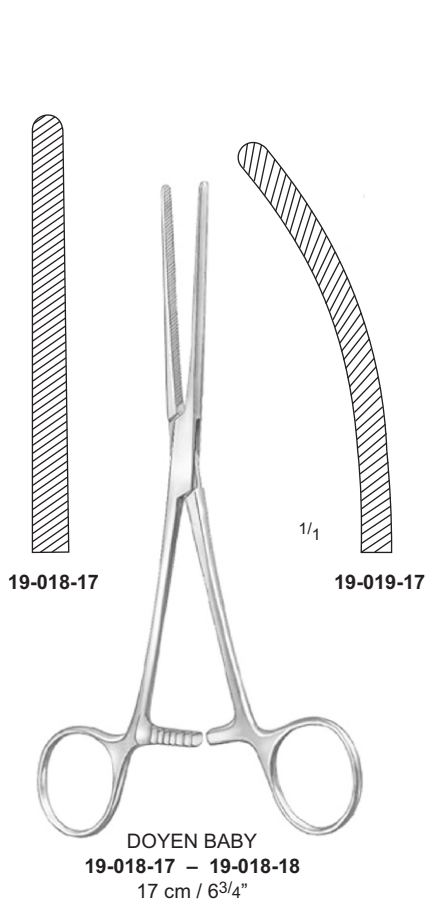

Intestinal Clamp Forceps



Atraumatic Clamp Forceps

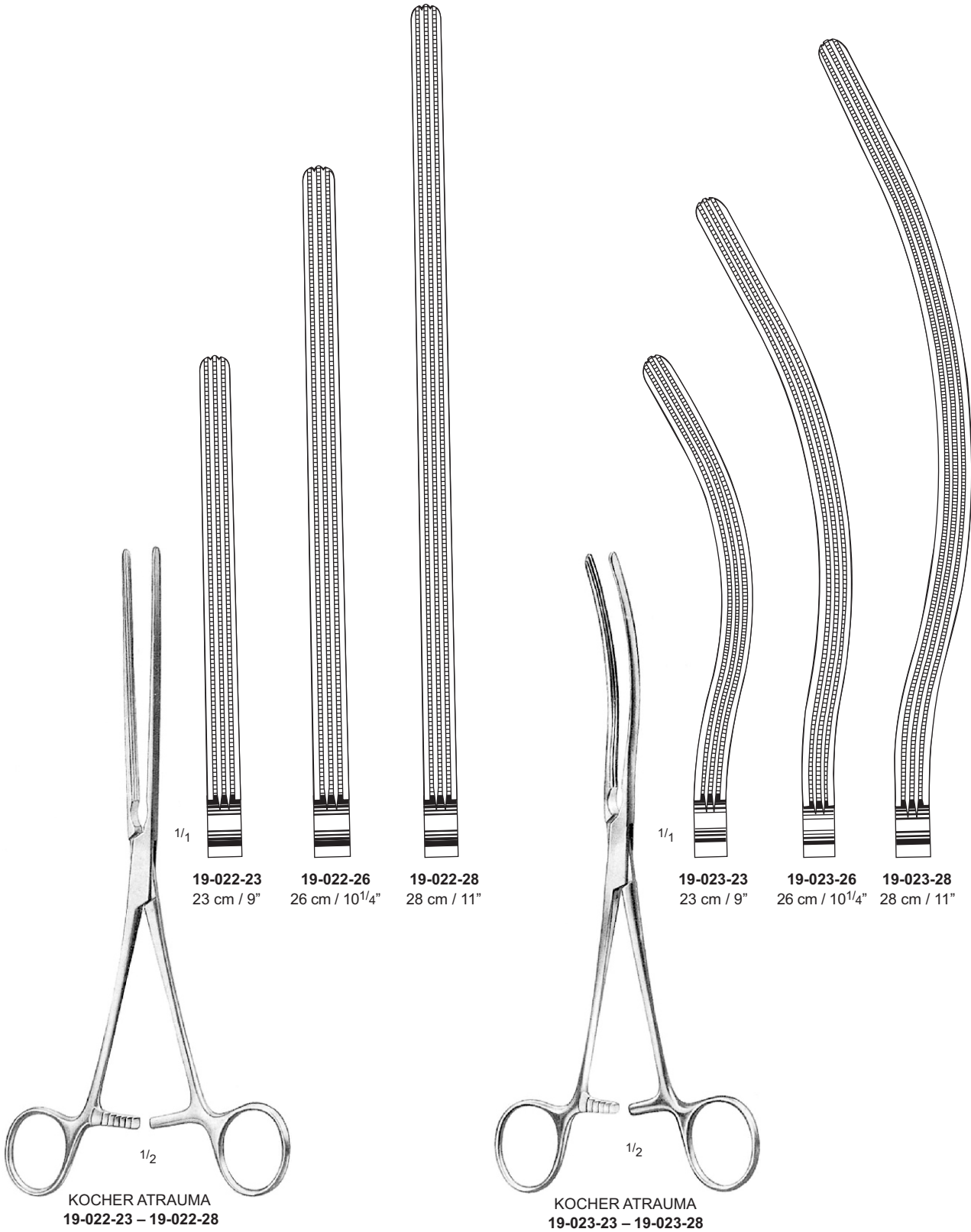

Intestinal Clamp Forceps

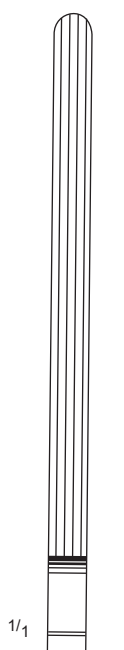

19-025-21
 21 cm / 8¹/₄"

019-025-23
 23 cm / 9"

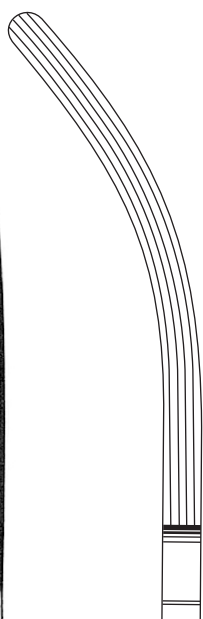

19-026-21
 21 cm / 8¹/₄"

19-026-23
 23 cm / 9"

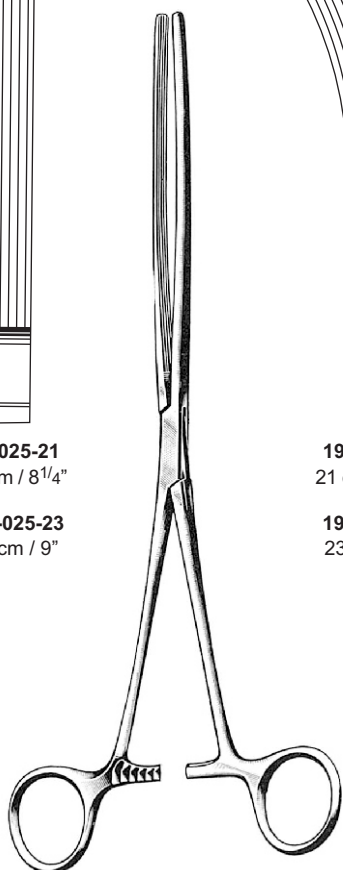

MAYO ROBSON
 19-025-21 – 19-025-24

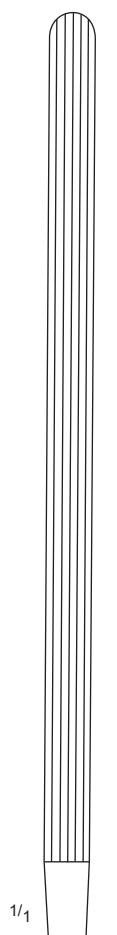

19-025-25
 25 cm / 10"

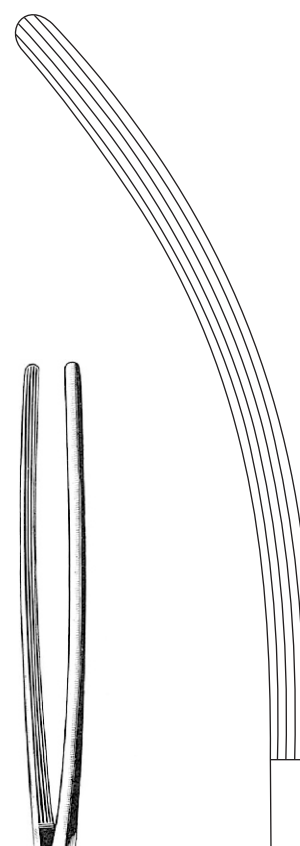

19-026-25
 25 cm / 10"

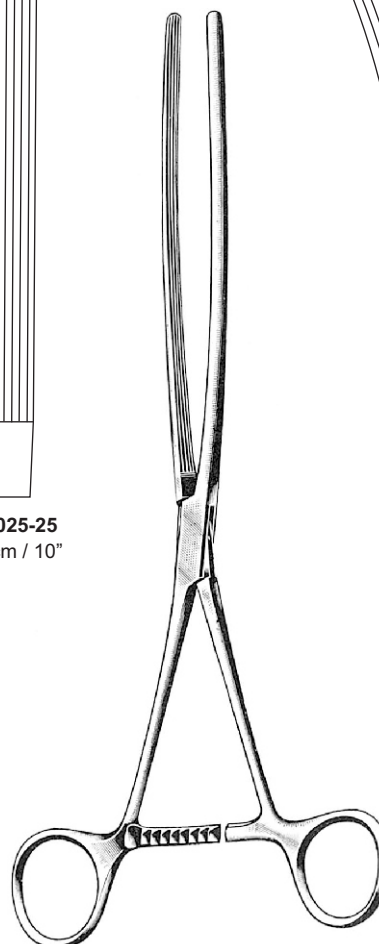

MAYO ROBSON
 19-025-25 – 019-025-26

Intestinal and Stomach Clamps

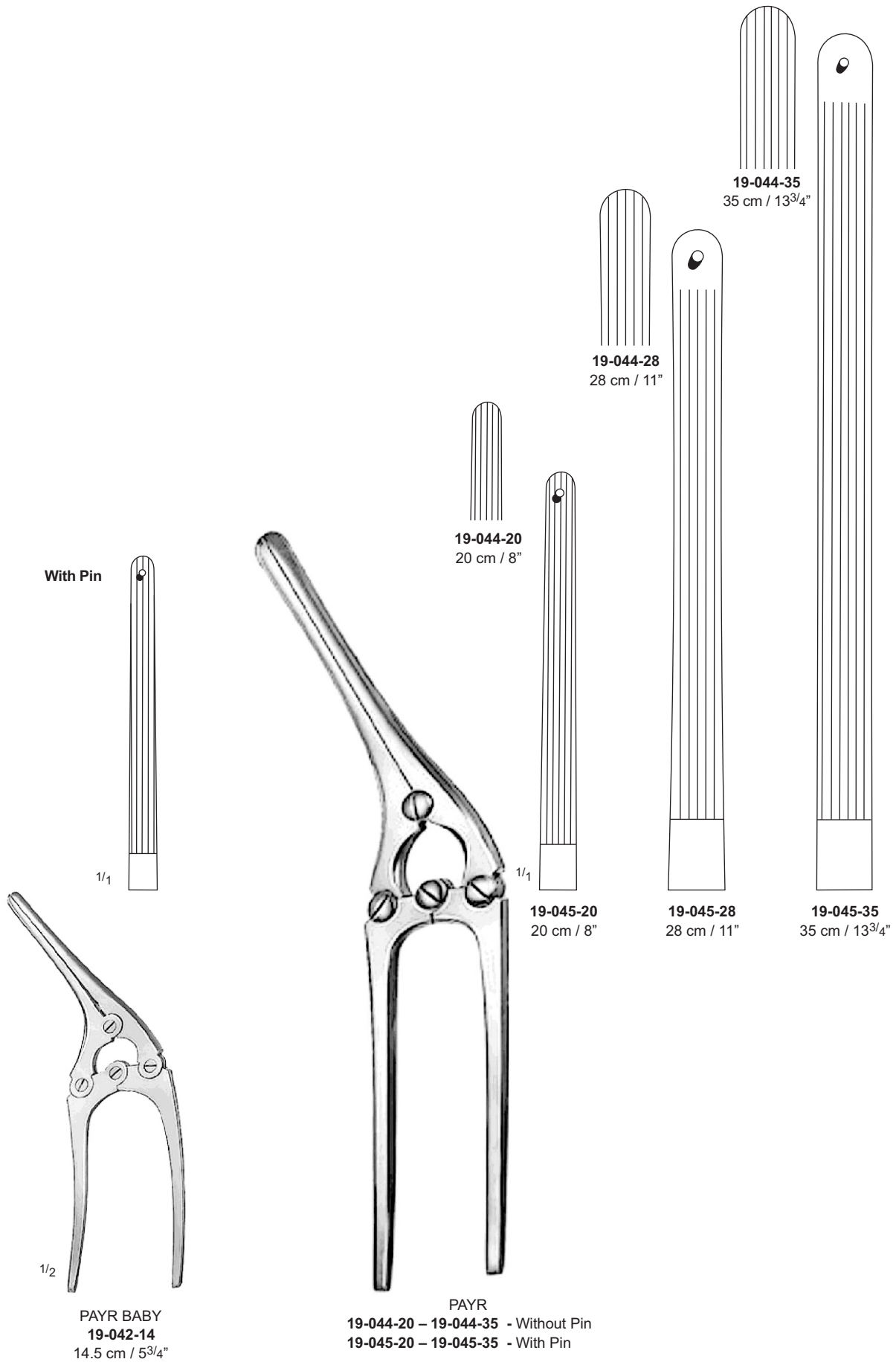

Rectal Specula

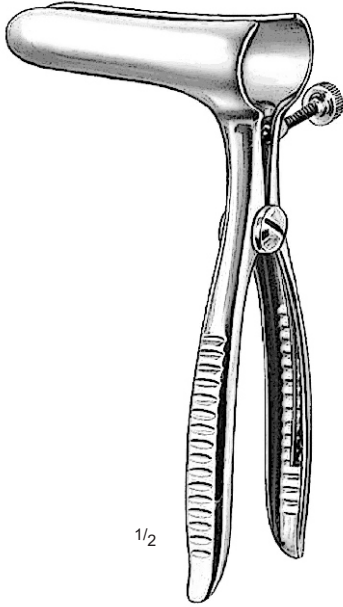

SIMS
19-052-16
16 cm / 6¹/₄"



SIMS
19-053-16
16 cm / 6¹/₄"

3 Blades



MATHIEU
19-058-21
21 cm / 8¹/₄"

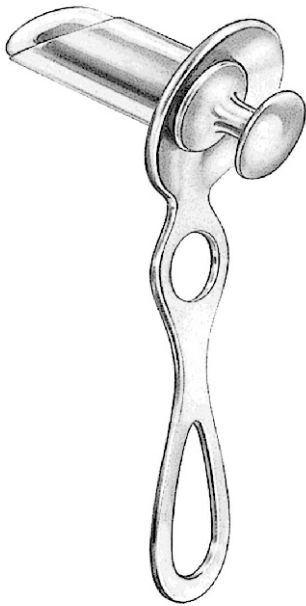

HIRSCHMANN

- 19-064-16 – ø 16 mm x 60 mm
- 19-064-19 – ø 19 mm x 70 mm
- 19-064-22 – ø 22 mm x 90 mm

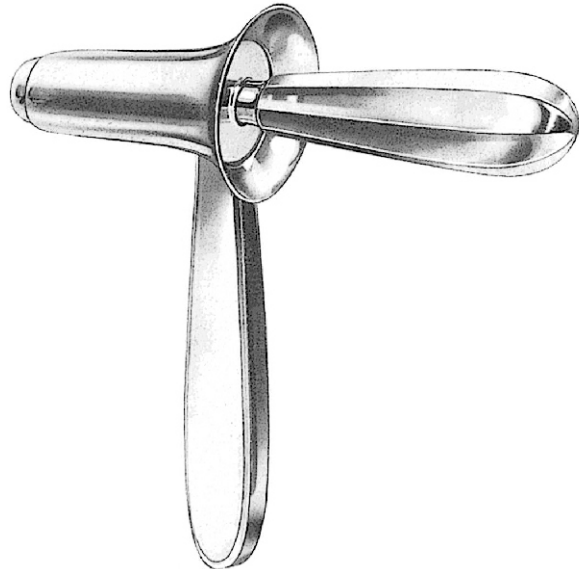

KELLY

- 19-061-21 – ø 21 mm x 50 mm
- 19-061-25 – ø 25 mm x 50 mm

- 19-062-23 – ø 23 mm x 145 mm
- 19-062-24 – ø 23 mm x 205 mm



NEWMAN

- 19-063-16 – ø 16 mm x 63 mm
- 19-063-19 – ø 19 mm x 63 mm
- 19-063-23 – ø 23 mm x 63 mm

Biopsy Specimen Forceps

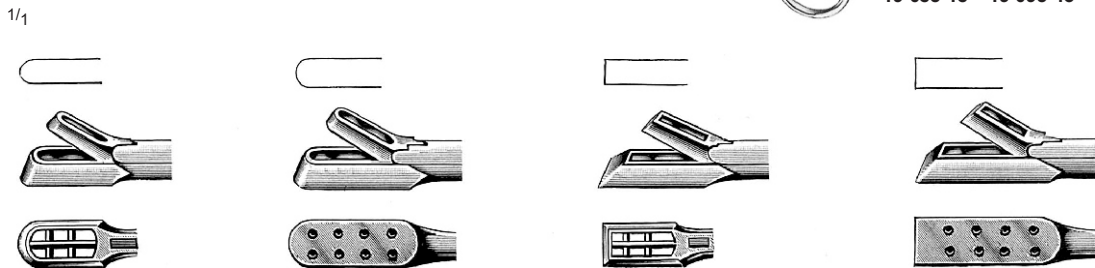
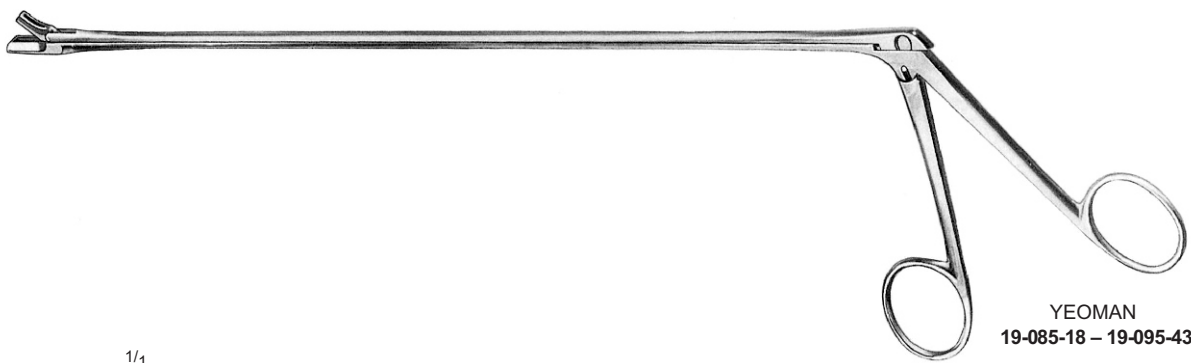
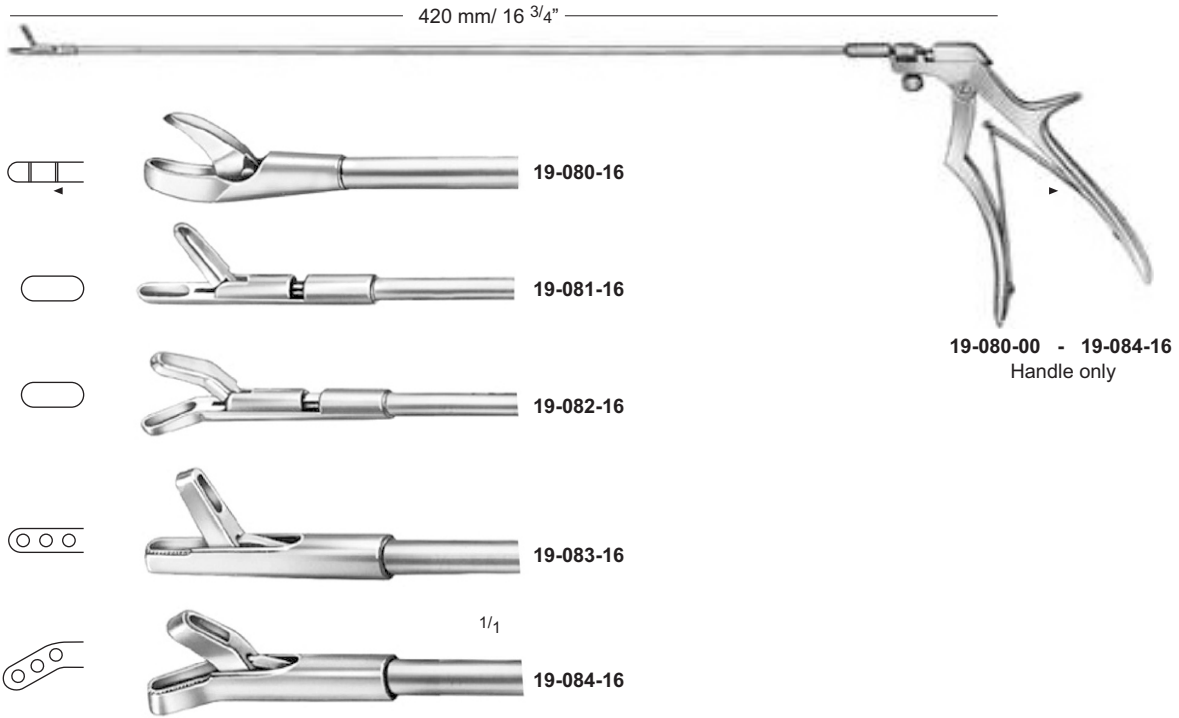

Shaft length	19-086-18	19-087-28	19-088-18	19-089-28
28 cm / 11"	19-086-18	19-087-28	19-088-18	19-089-28
35 cm / 13 3/4"	19-086-25	19-087-35	19-088-25	19-089-35
43 cm / 17"	19-086-33	19-087-43	19-08-33	19-089-43

Pelvis Retractor

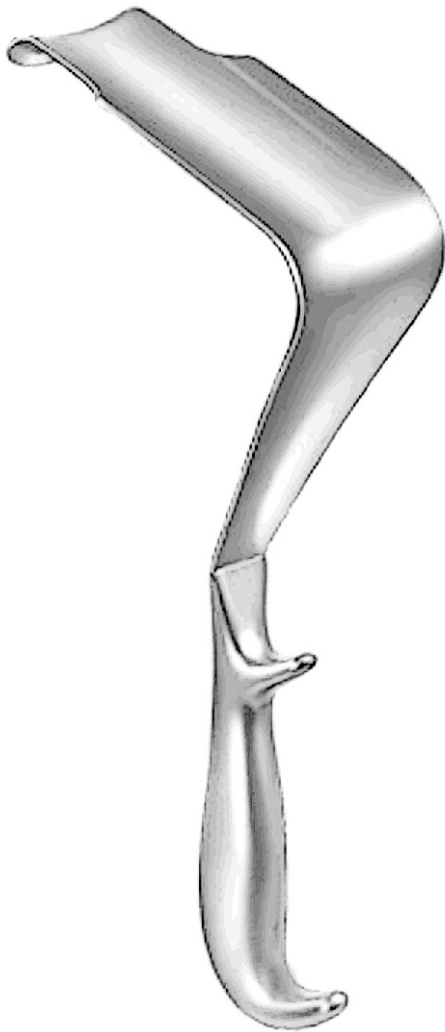

ST. MARKS
 (LLOYD DAVIS)
 19-091-30 – 19-089-33

