

# Gynecology

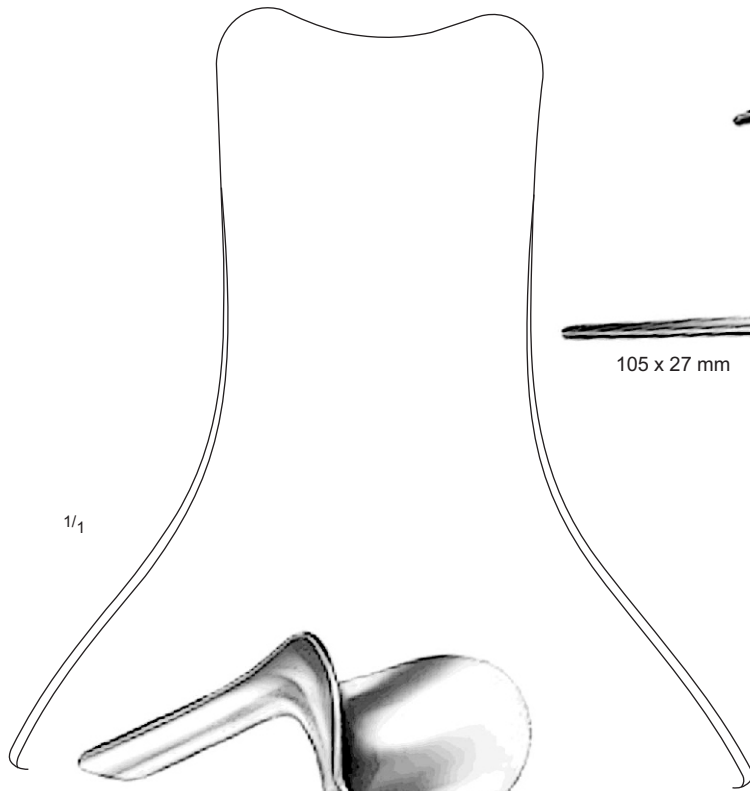

20

Vaginal Specula and Retractors



1/1

Complete with  
removable weight

1/2

AUVARD  
20-001-24  
24 cm / 9 1/2"

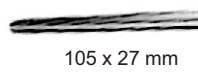

105 x 27 mm

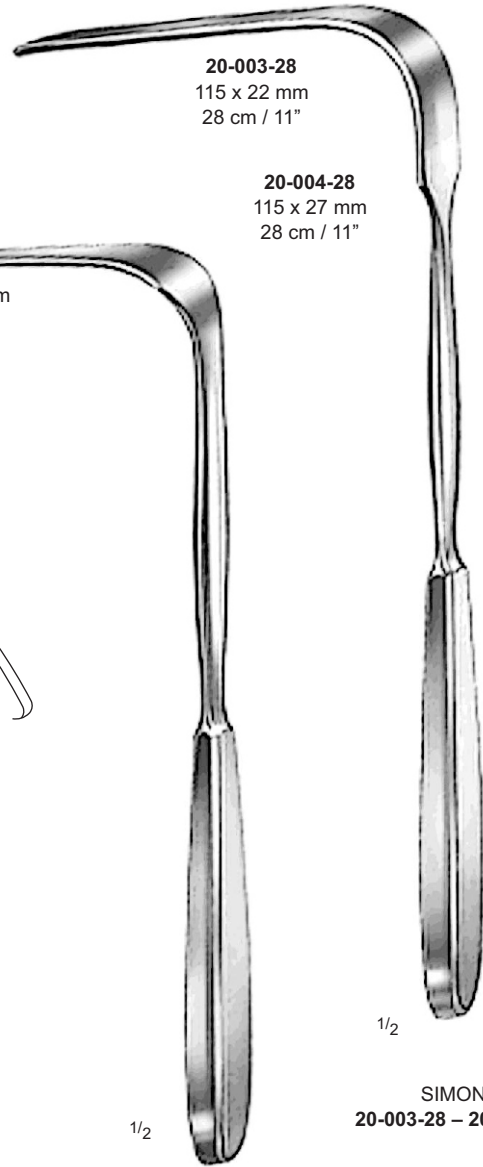

20-003-28  
115 x 22 mm  
28 cm / 11"

20-004-28  
115 x 27 mm  
28 cm / 11"

1/2

1/2

MARTIN  
20-002-25  
25 cm / 10"

SIMON  
20-003-28 – 20-004-28

Vaginal Specula and Retractors

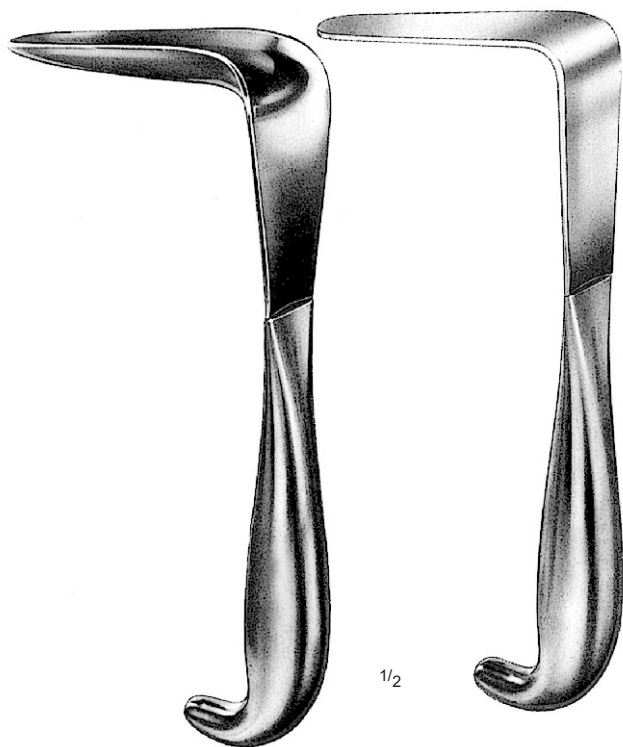

**MATHIEU**  
 20-009-26 – 95 x 16 - 26 mm  
 20-010-30 – 95 x 16 - 30 mm  
 Vaginal Specula

**MATHIEU**  
 20-011-20 – 100 x 11 - 20 mm  
 20-012-26 – 100 x 14 - 26 mm  
 Vaginal Retractor



1/2

**KRISTELLER**  
 Set of one Speculum  
 and one Retractor  
 20-019-27 – Fig. 1  
 20-020-30 – Fig. 2  
 20-021-36 – Fig. 3

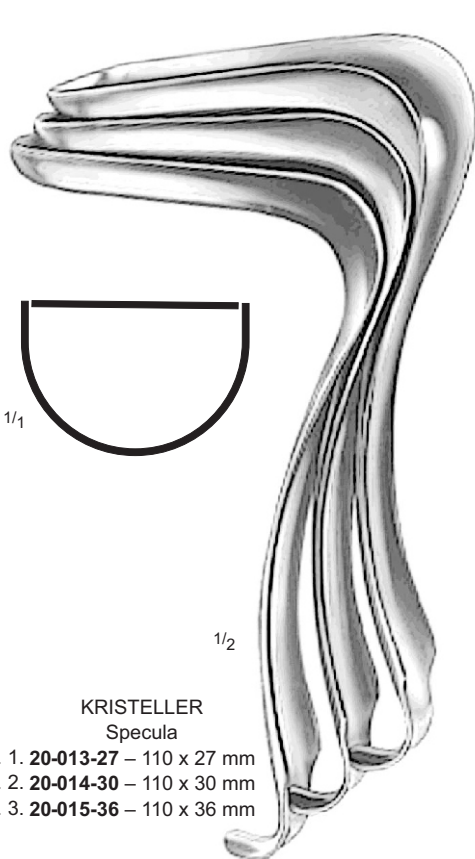

1/4

1/2

**KRISTELLER**  
 Specula  
 Fig. 1. 20-013-27 – 110 x 27 mm  
 Fig. 2. 20-014-30 – 110 x 30 mm  
 Fig. 3. 20-015-36 – 110 x 36 mm

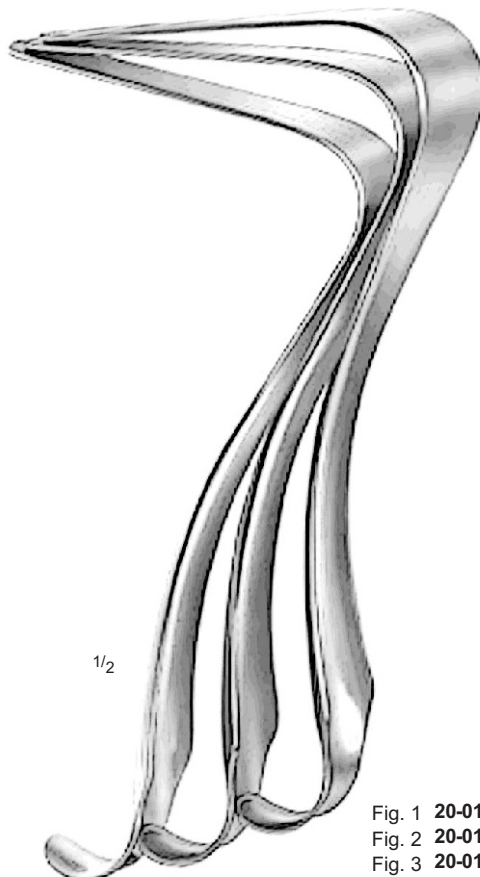

1/2

**KRISTELLER**  
 Retractors  
 Fig. 1 20-016-23 – 115 x 23 mm  
 Fig. 2 20-017-26 – 115 x 26 mm  
 Fig. 3 20-018-32 – 115 x 32 mm

Vaginal Specula and Retractors

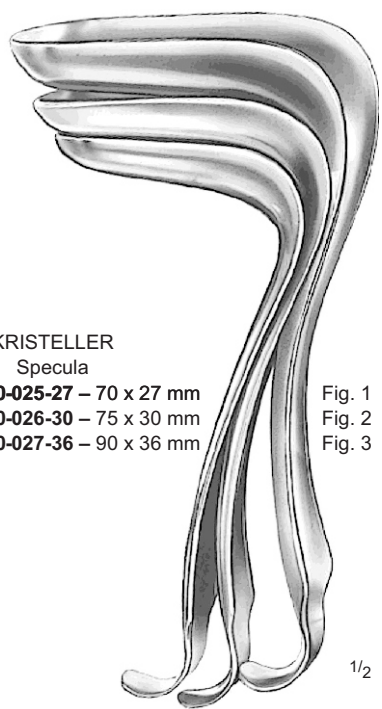

KRISTELLER  
 Specula

- Fig. 1 **20-025-27** – 70 x 27 mm  
 Fig. 2 **20-026-30** – 75 x 30 mm  
 Fig. 3 **20-027-36** – 90 x 36 mm

1/2

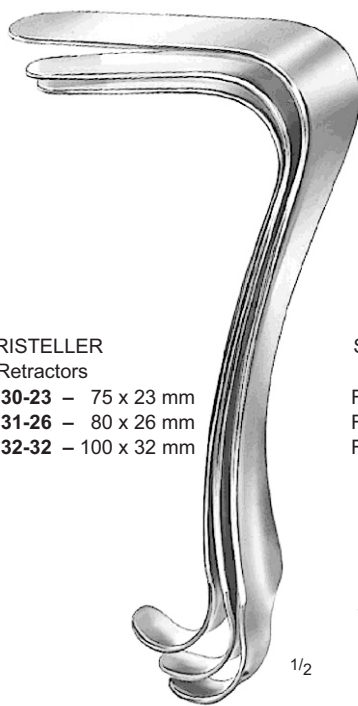

KRISTELLER  
 Retractors

- Fig. 1 **20-030-23** – 75 x 23 mm  
 Fig. 2 **20-031-26** – 80 x 26 mm  
 Fig. 3 **20-032-32** – 100 x 32 mm

1/2

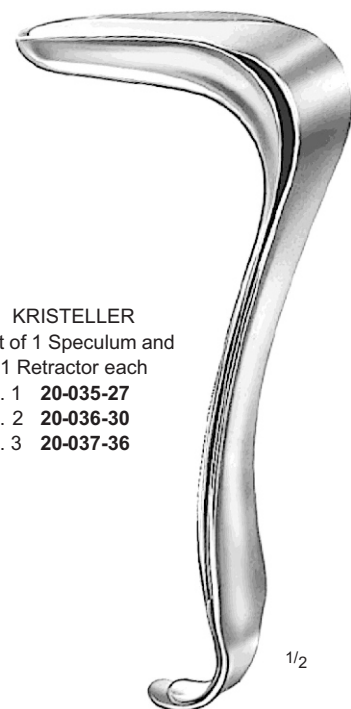

KRISTELLER  
 Set of 1 Speculum and  
 1 Retractor each

- Fig. 1 **20-035-27**  
 Fig. 2 **20-036-30**  
 Fig. 3 **20-037-36**

1/2

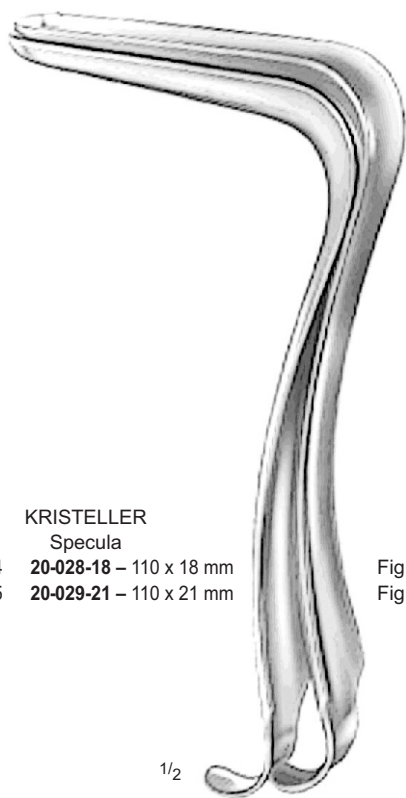

KRISTELLER  
 Specula

- Fig. 4 **20-028-18** – 110 x 18 mm  
 Fig. 5 **20-029-21** – 110 x 21 mm

1/2

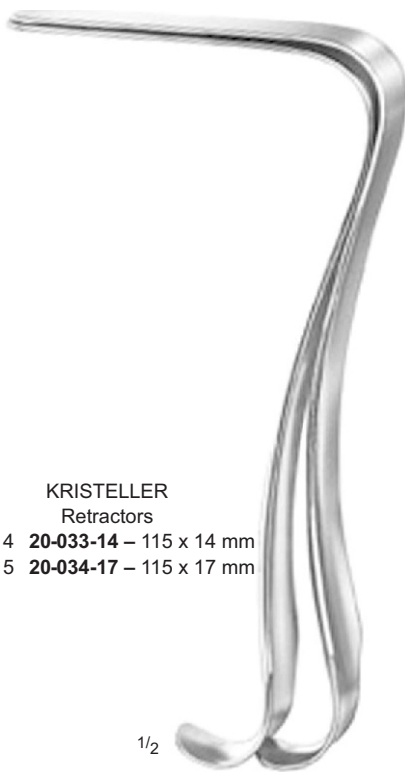

KRISTELLER  
 Retractors

- Fig. 4 **20-033-14** – 115 x 14 mm  
 Fig. 5 **20-034-17** – 115 x 17 mm

1/2



KRISTELLER  
 Set of 1 Speculum  
 and 1 Retractor each

- Fig. 4 **20-038-18**  
 Fig. 5 **20-039-21**

1/2

Vaginal Specula and Retractors

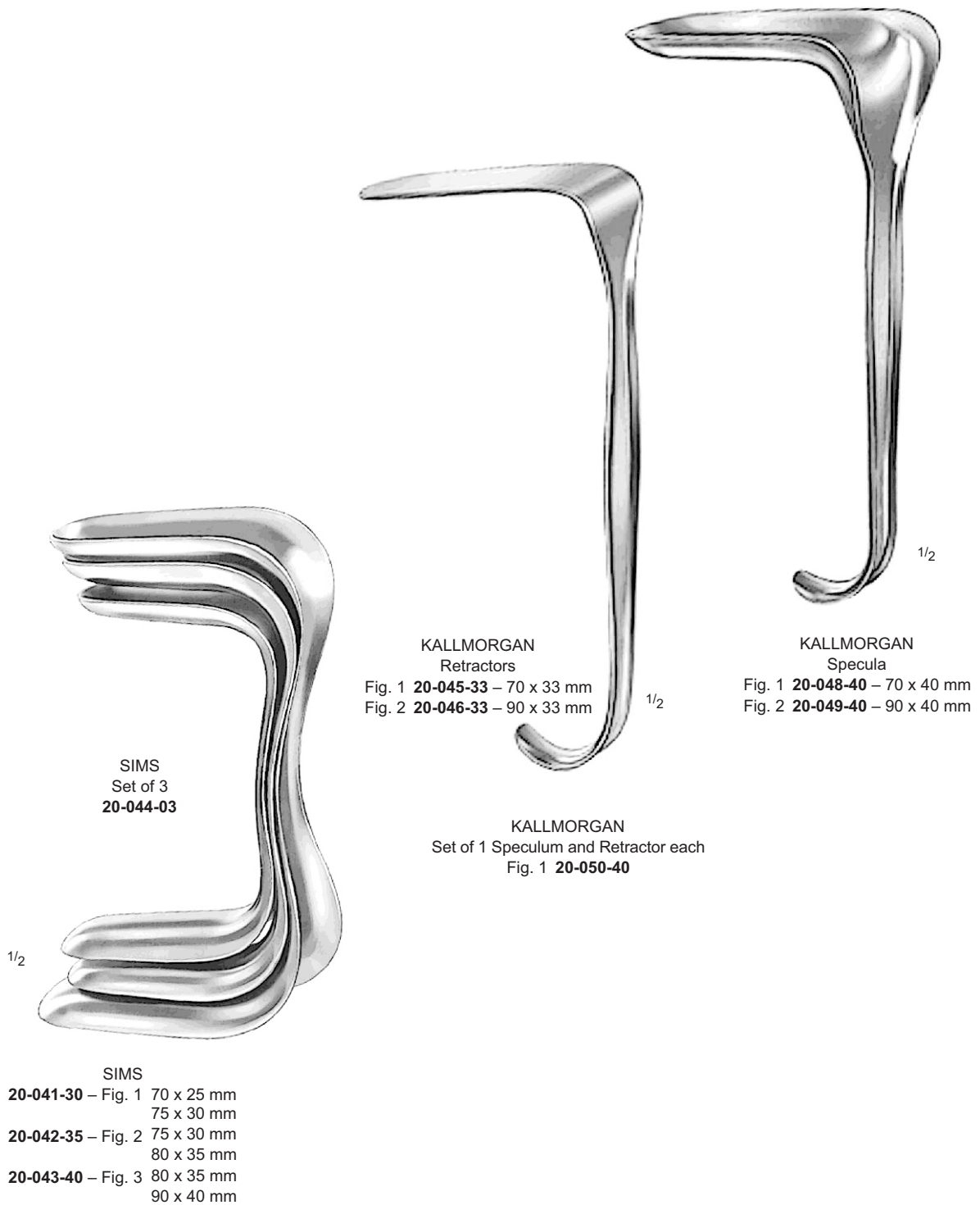

SIMS  
 Set of 3  
 20-044-03

1/2

- SIMS
- 20-041-30 – Fig. 1 70 x 25 mm  
 75 x 30 mm
  - 20-042-35 – Fig. 2 75 x 30 mm  
 80 x 35 mm
  - 20-043-40 – Fig. 3 80 x 35 mm  
 90 x 40 mm

KALLMORGAN  
 Retractors

- Fig. 1 20-045-33 – 70 x 33 mm
- Fig. 2 20-046-33 – 90 x 33 mm

1/2

KALLMORGAN  
 Set of 1 Speculum and Retractor each  
 Fig. 1 20-050-40

KALLMORGAN  
 Specula

- Fig. 1 20-048-40 – 70 x 40 mm
- Fig. 2 20-049-40 – 90 x 40 mm

1/2

Vaginal Specula and Retractors

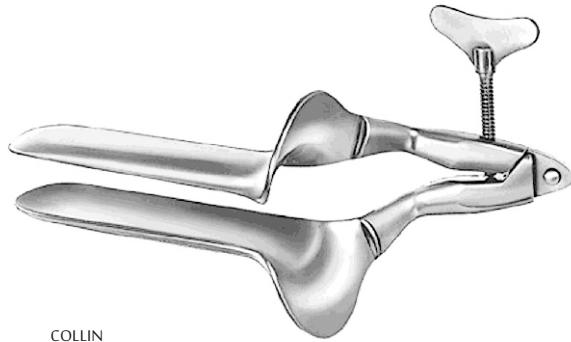

COLLIN  
 20-055-25 – 90 x 25 mm  
 20-056-29 – 90 x 29 mm  
 20-057-35 – 100 x 35 mm  
 20-058-40 – 100 x 40 mm  
 20-059-36 – 110 x 36 mm  
 20-060-41 – 110 x 40 mm

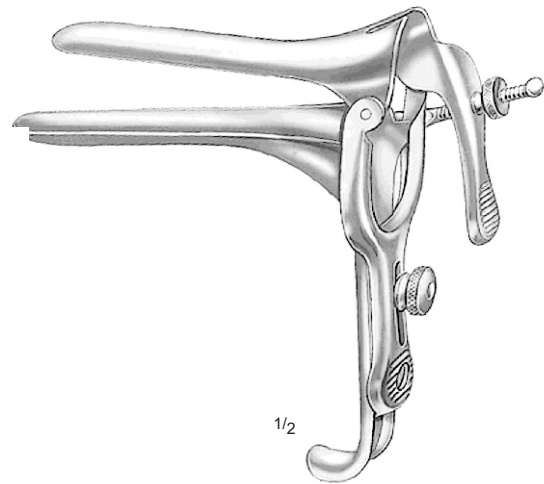

1/2  
 PEDERSON  
 20-061-13 – 76 x 13 mm  
 20-062-22 – 100 x 22 mm  
 20-063-25 – 120 x 25 mm



1/3

20-071-20 – 100 x 20 mm  
 20-072-25 – 100 x 25 mm  
 20-072-30 – 100 x 30 mm  
 20-074-35 – 100 x 35 mm  
 20-075-40 – 100 x 40 mm  
 20-076-20 – 130 x 20 mm  
 20-077-25 – 130 x 25 mm  
 20-078-30 – 130 x 30 mm  
 20-079-35 – 130 x 35 mm  
 20-080-40 – 130 x 40 mm

BRIESKY  
 20-071-20 – 20-080-40  
 27 - 30 cm / 10 3/4" – 11 3/4"

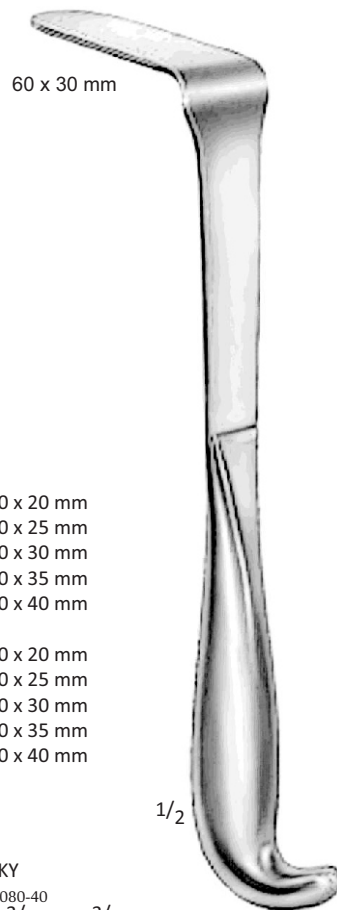

1/2

DOYEN  
 20-081-23  
 23 cm / 9"



1/2

GRAVES  
 20-064-20 – 75 x 20 mm  
 20-065-30 – 100 x 30 mm  
 20-066-35 – 115 x 35 mm

Vaginal Specula

Central Fixation Screw

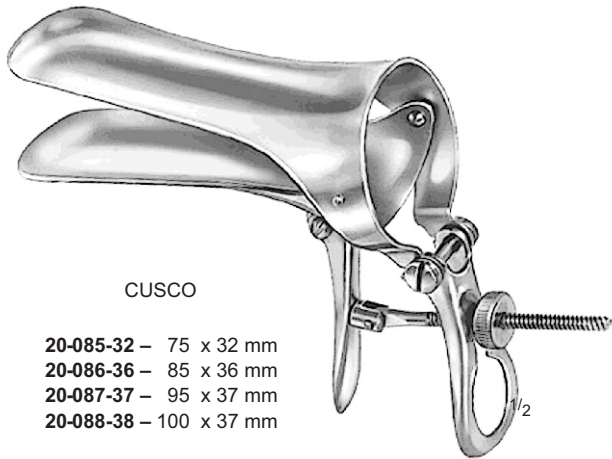

CUSCO

- 20-085-32 – 75 x 32 mm
- 20-086-36 – 85 x 36 mm
- 20-087-37 – 95 x 37 mm
- 20-088-38 – 100 x 37 mm

For Virgins

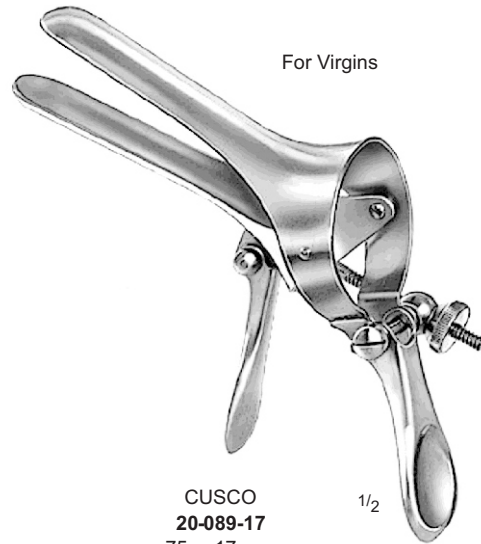

CUSCO  
 20-089-17  
 75 x 17 mm

Swiss Pattern

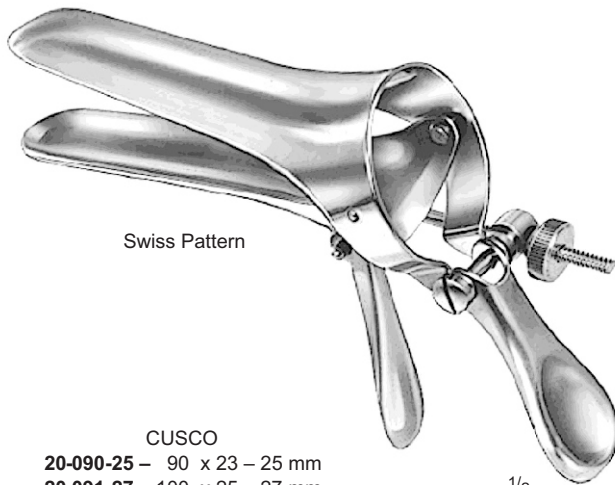

CUSCO

- 20-090-25 – 90 x 23 – 25 mm
- 20-091-27 – 100 x 25 – 27 mm
- 20-092-30 – 110 x 27 – 30 mm

Lateral Fixation Screw

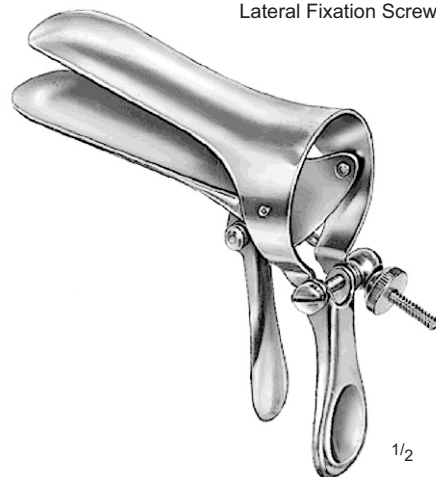

CUSCO  
 20-093-32 – 75 x 32 mm  
 20-094-36 – 85 x 36 mm  
 20-095-37 – 95 x 37 mm  
 20-096-35 – 100 x 35 mm

With Sloped Handle

mm Ø

1	20-038-01
2	20-038-02
3	20-038-03
4	20-038-04
5	20-038-05
6	20-038-06
7	20-038-07
8	20-038-08
9	20-038-09
10	20-038-10
11	20-038-11
12	20-038-12
13	20-038-13
14	20-038-14
15	20-038-15
16	20-038-16
17	20-038-17
18	20-038-18
19	20-038-19
20	20-038-20
21	20-038-21
22	20-038-22
23	20-038-23
24	20-038-24
25	20-038-25
26	20-038-26



HEGAR  
 20-038-01 – 20-038-26



Uterine Dilators

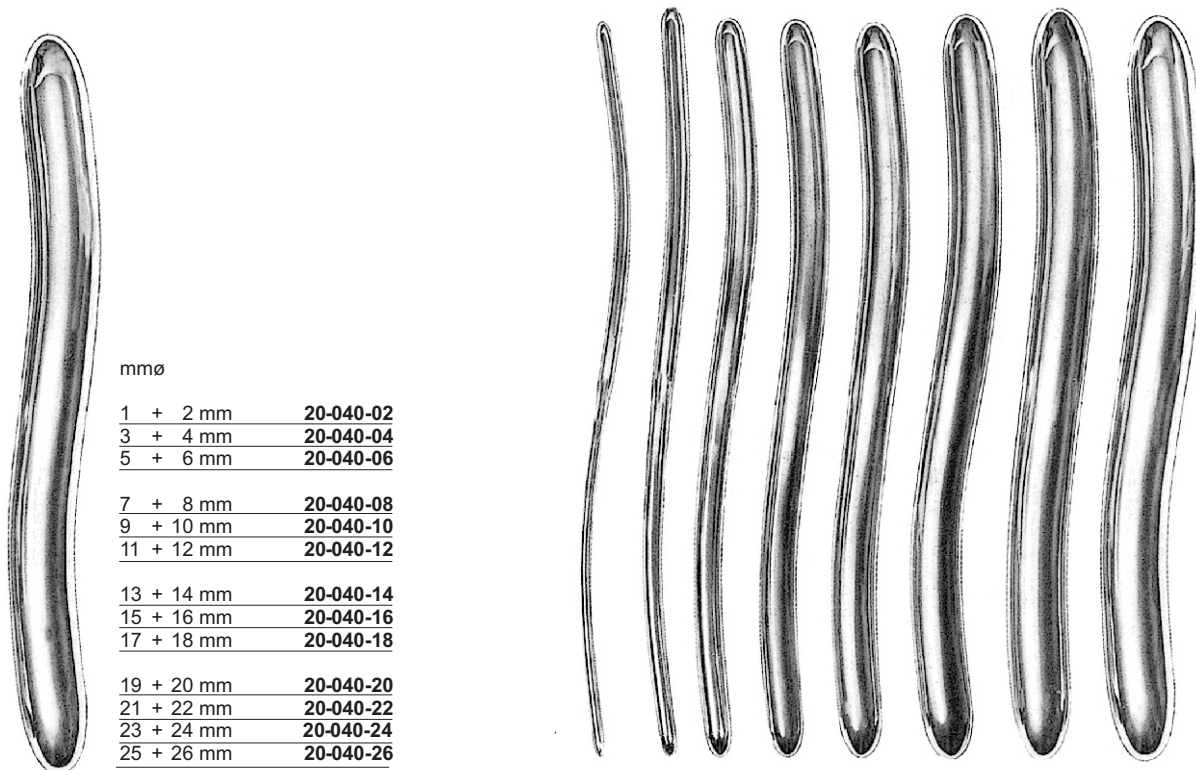

mmø

1 + 2 mm	20-040-02
3 + 4 mm	20-040-04
5 + 6 mm	20-040-06
7 + 8 mm	20-040-08
9 + 10 mm	20-040-10
11 + 12 mm	20-040-12
13 + 14 mm	20-040-14
15 + 16 mm	20-040-16
17 + 18 mm	20-040-18
19 + 20 mm	20-040-20
21 + 22 mm	20-040-22
23 + 24 mm	20-040-24
25 + 26 mm	20-040-26

HEGAR



**20-040-30**  
Set of 8 dilators, 3 + 4mm – 17 + 18 mm,  
in canvas roll.

Uterine Dilators

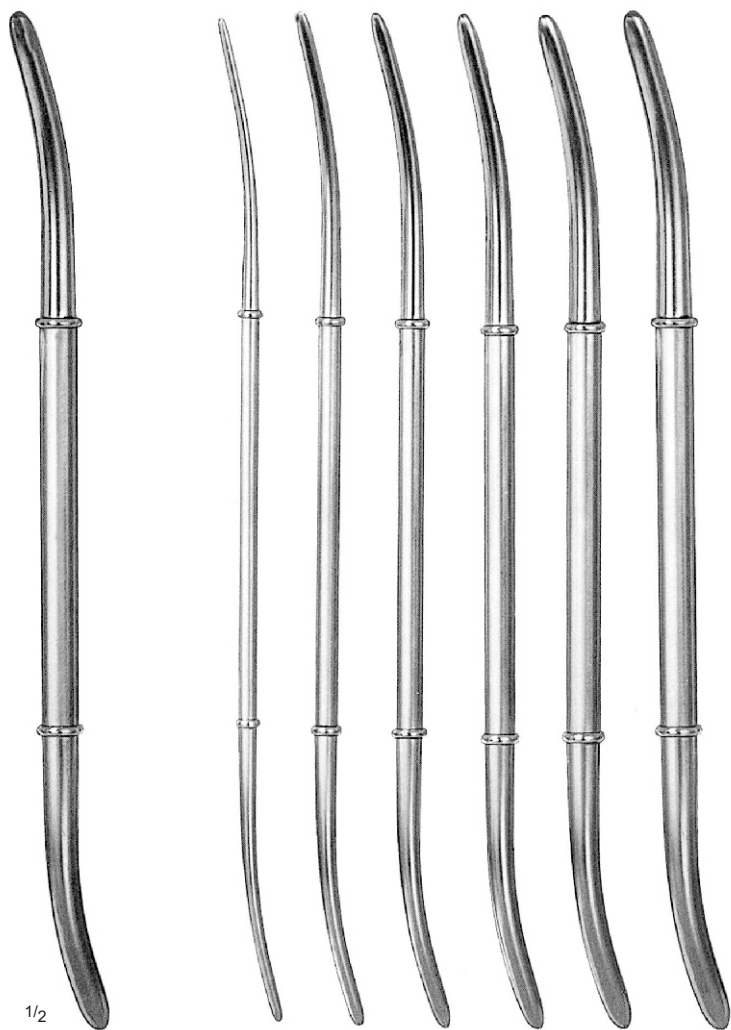

1/2

HANK  
20-041-10 – 20-041-20

ø mm

- 20-041-10 – Fig. 9/10 = 4.5 / 5 mm
- 20-041-12 – Fig. 11/12 = 5.5 / 6 mm
- 20-041-14 – Fig. 13/14 = 6.5 / 7 mm
- 20-041-16 – Fig. 15/16 = 7.5 / 8 mm
- 20-041-18 – Fig. 17/18 = 8.5 / 9 mm
- 20-041-20 – Fig. 19/20 = 9.5 / 10 mm

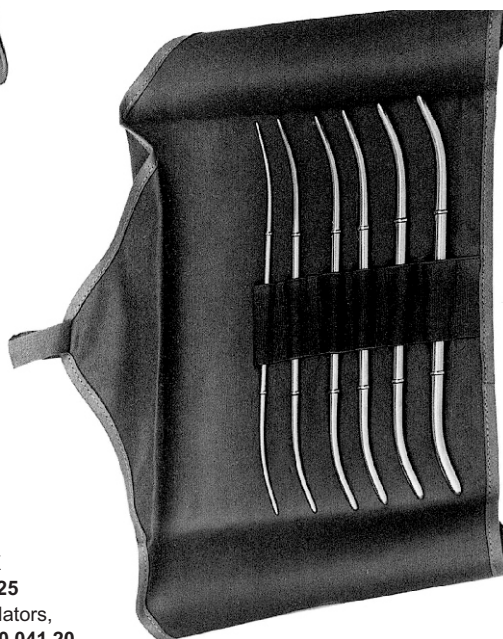

HANK  
20-041-25  
Set of 6 Dilators,  
20-041-10 – 20-041-20

Endocervical Specula, Uterine Sounds, Depressors

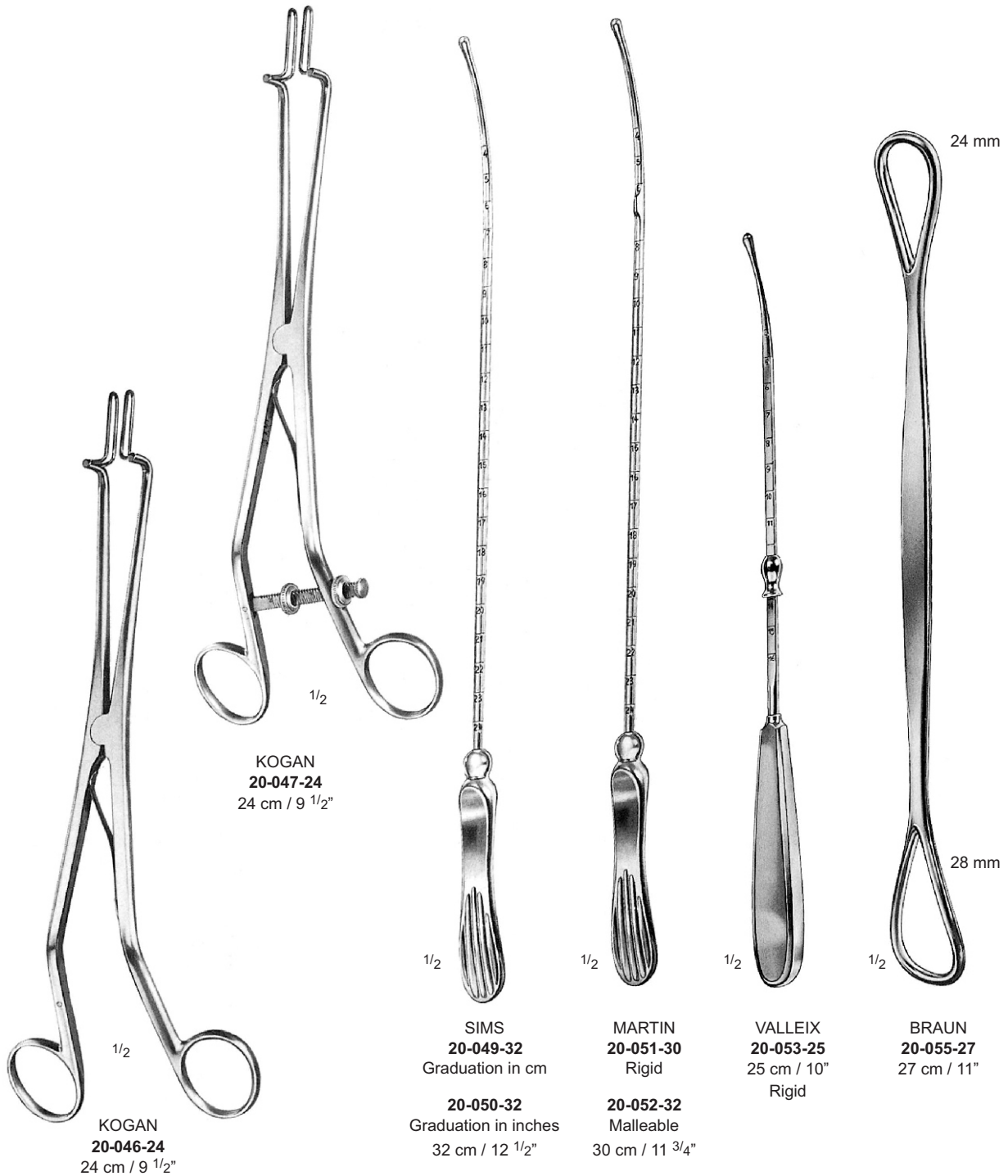

Tenaculum Forceps

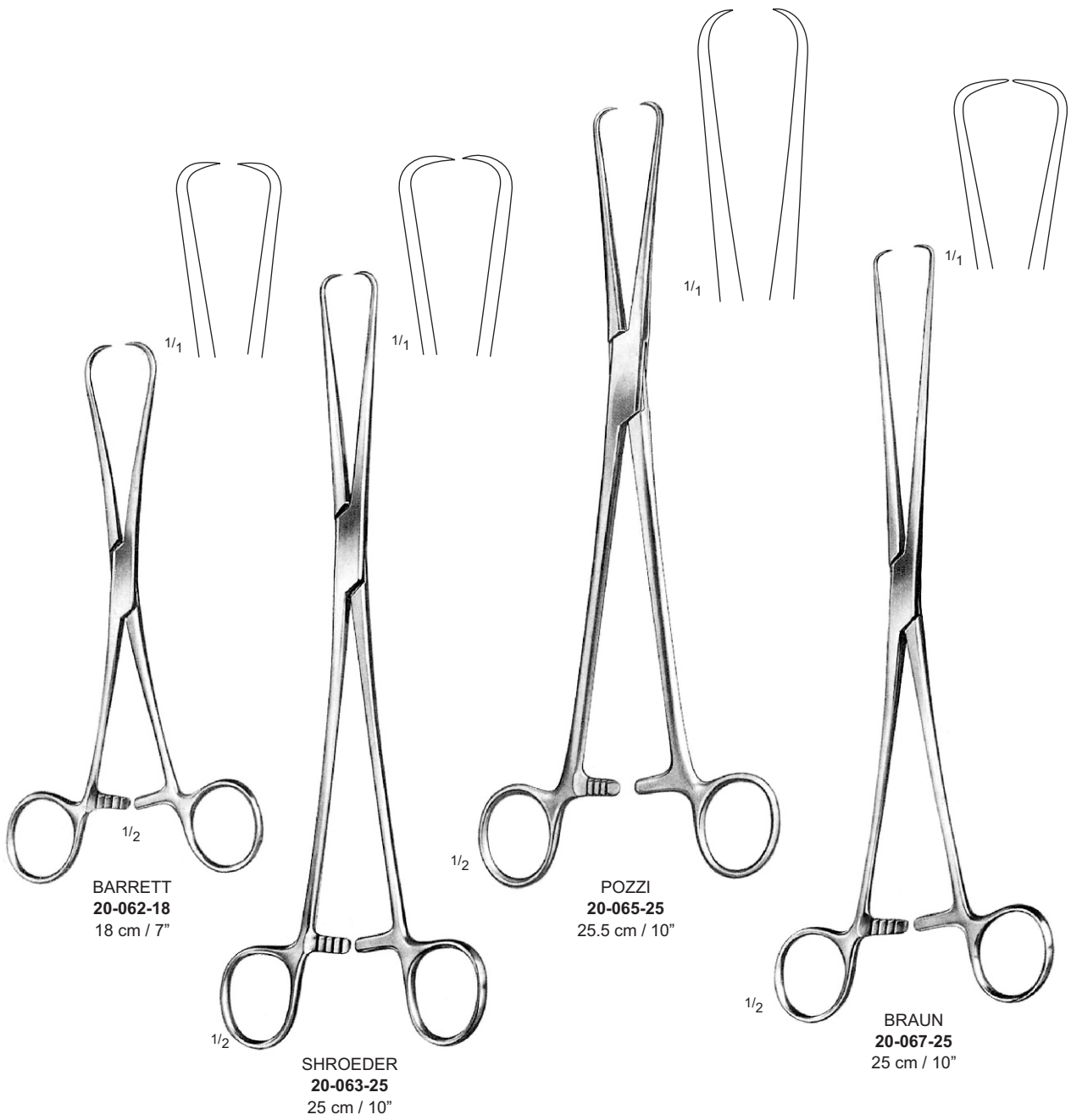

Tenaculum Forceps

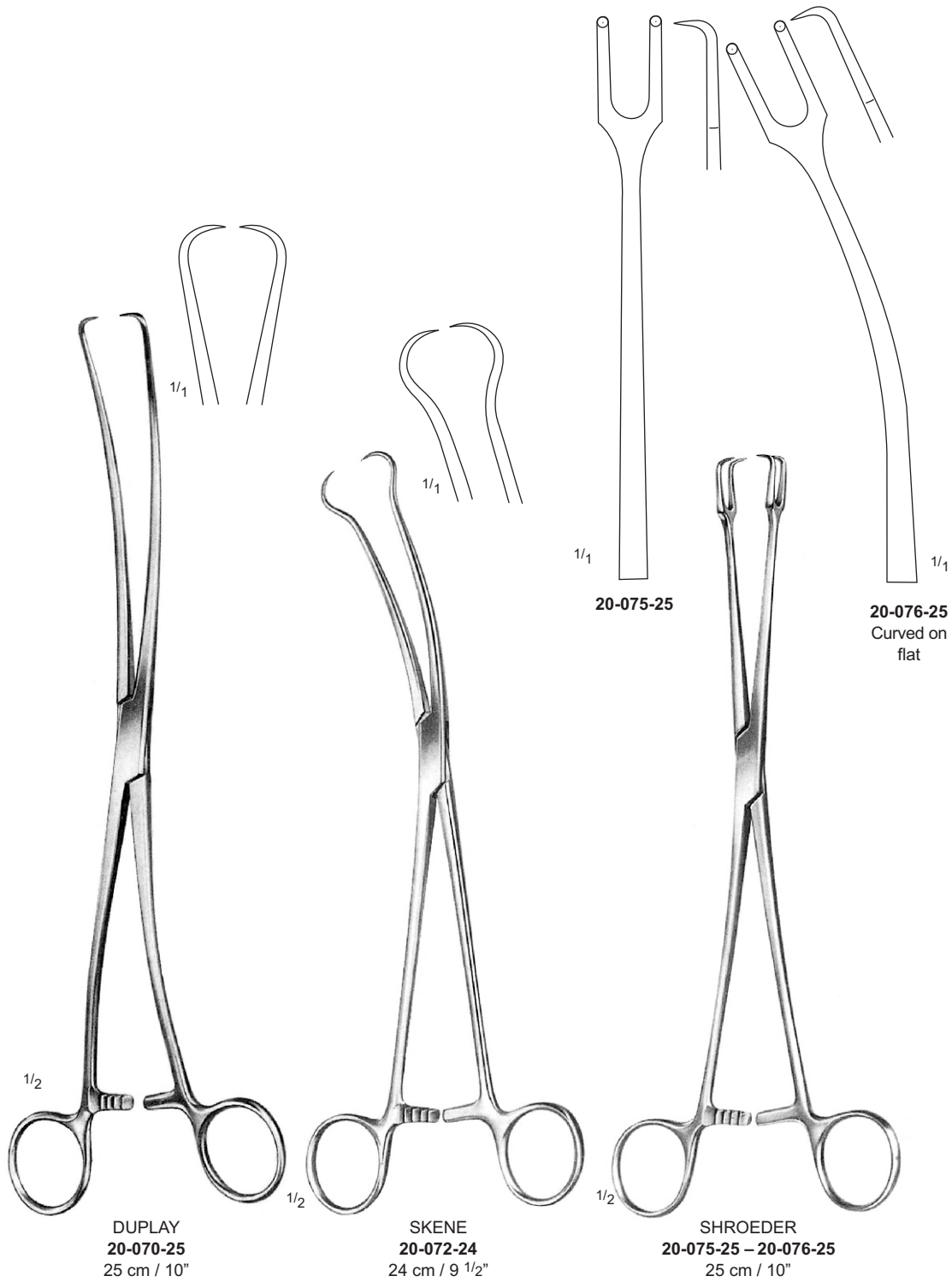

Uterine Tenaculum Forceps

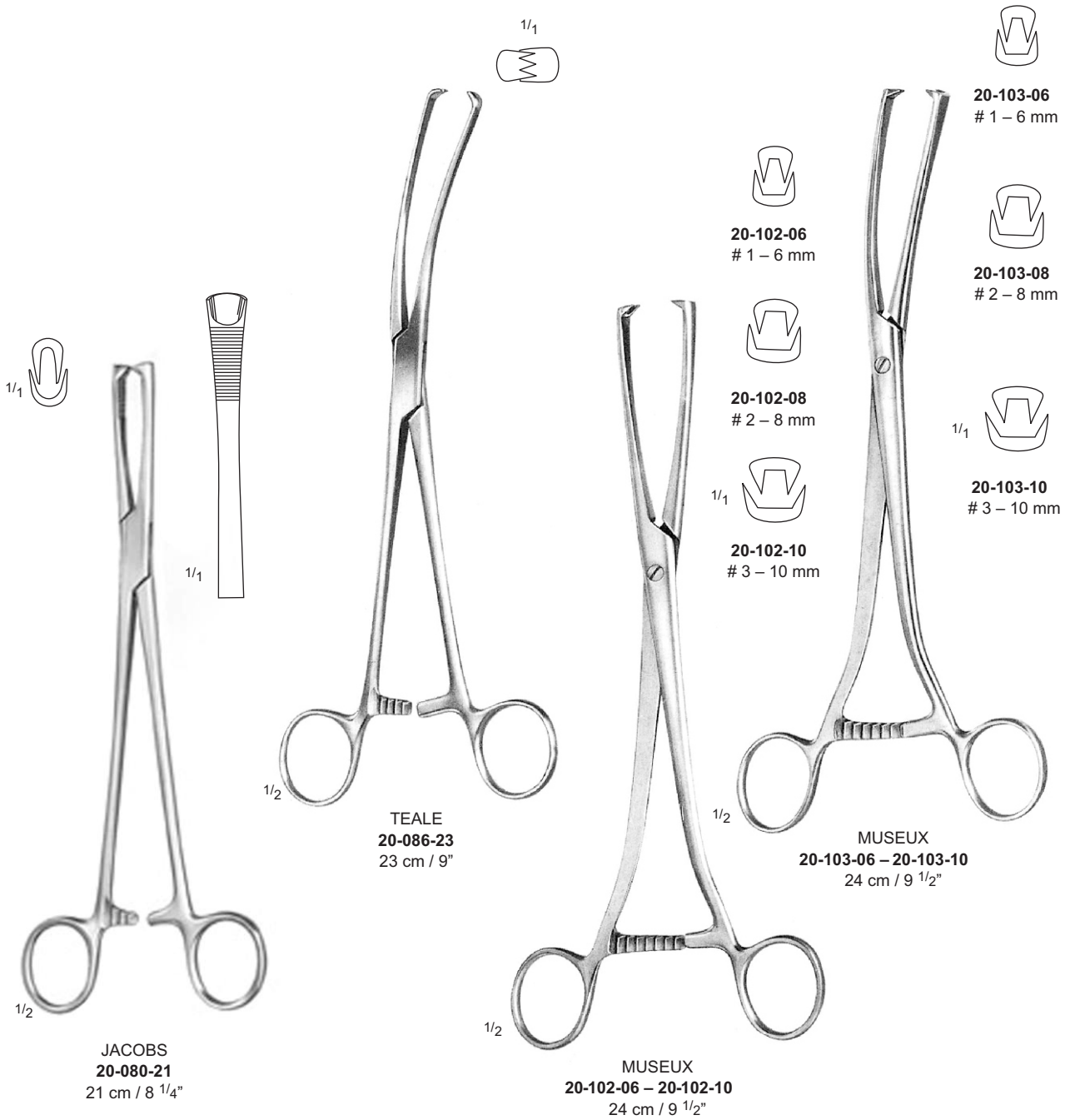

Uterine Polypus Forceps



Uterine Seizing Forceps

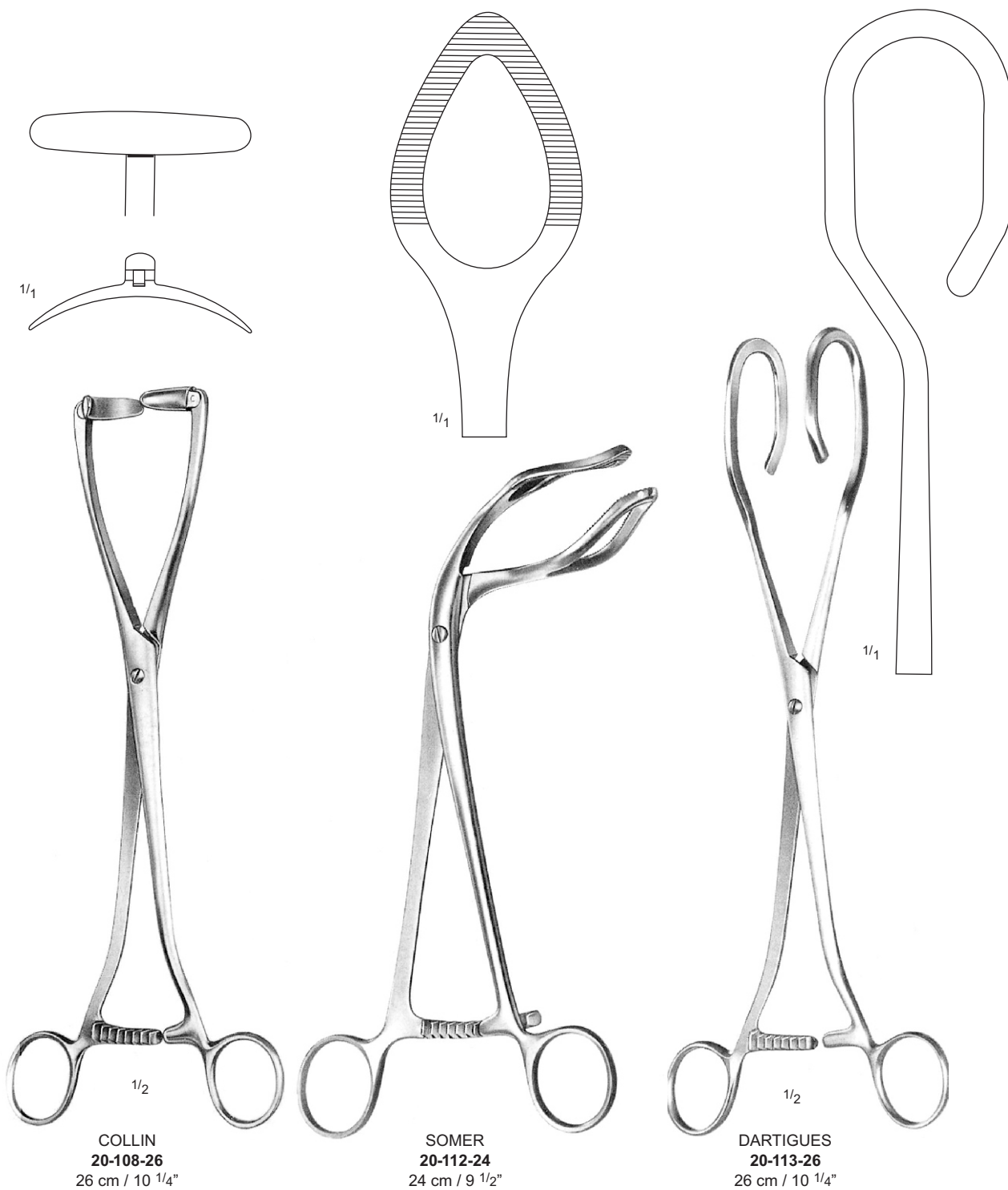



Cervical Biopsy Forceps

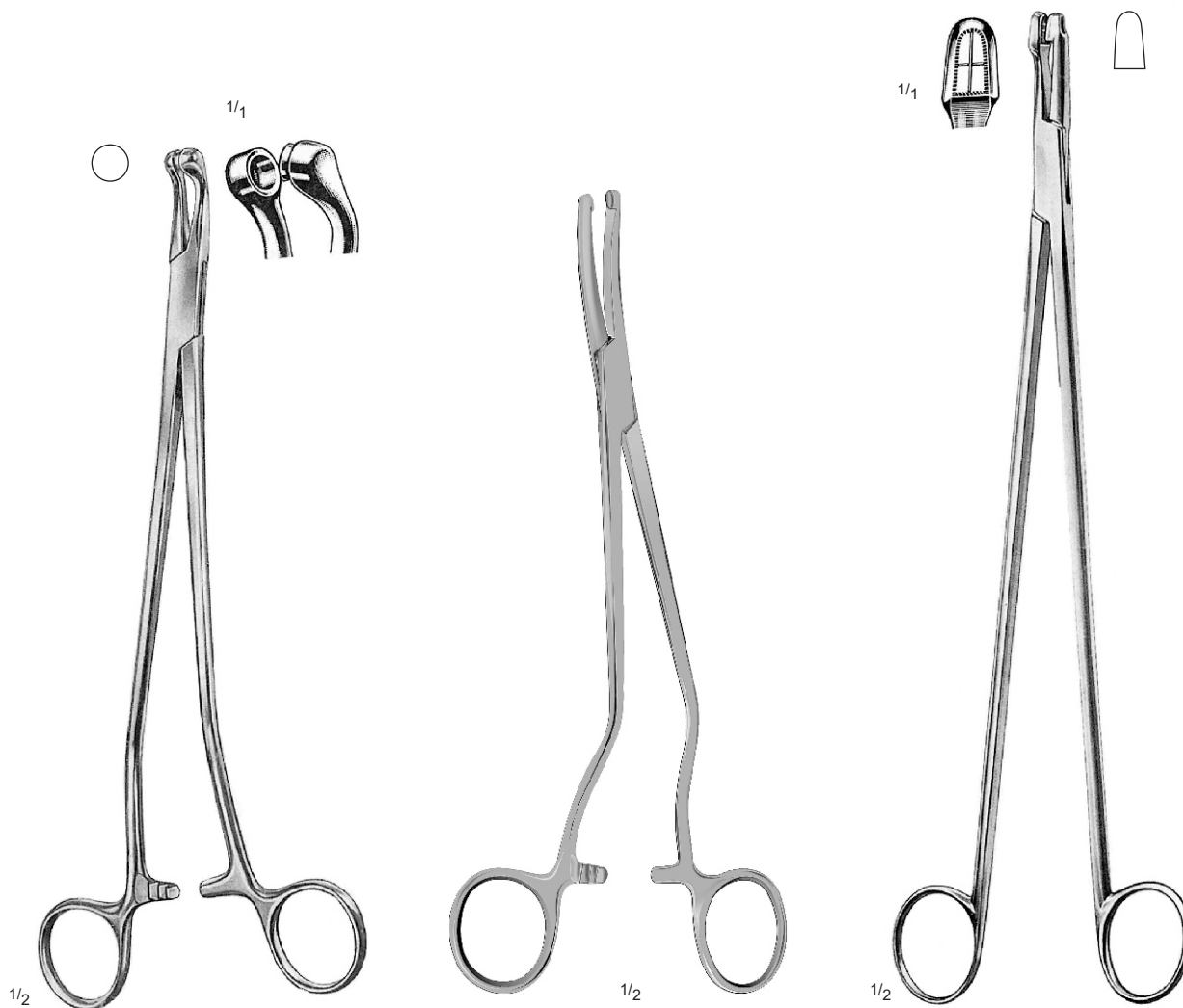

$\frac{1}{2}$   
**THOMS - GAYLOR**  
**20-123-24**  
 24 cm / 9 1/2"

$\frac{1}{2}$   
**PROFESSOR MEDINA**  
**20-124-22**  
 22 cm / 8 3/4"

$\frac{1}{2}$   
**SCHUBERT**  
**20-125-21**  
 21 cm / 8 1/4"

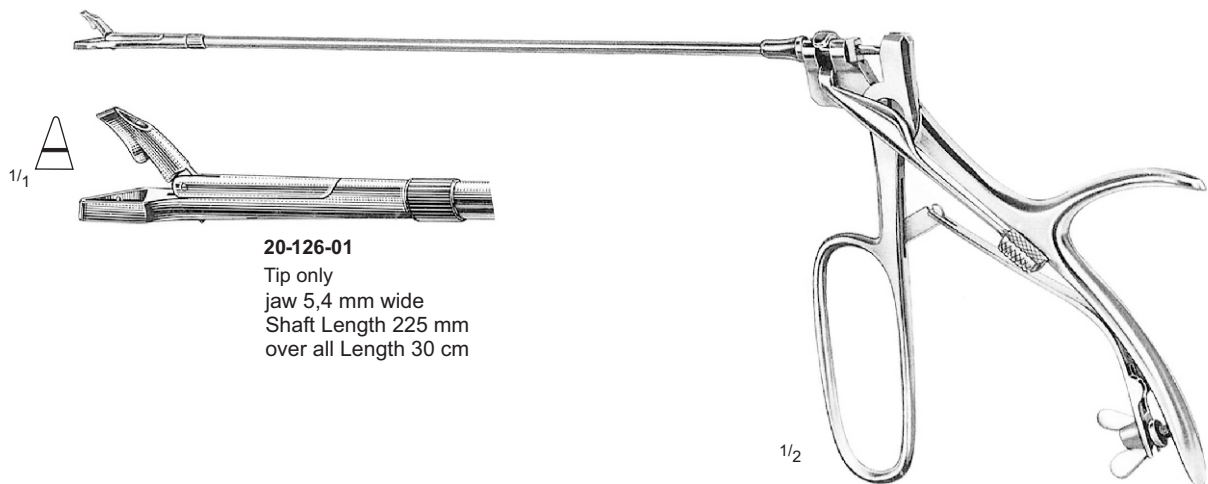

$\frac{1}{1}$   
**20-126-01**  
 Tip only  
 jaw 5,4 mm wide  
 Shaft Length 225 mm  
 over all Length 30 cm

$\frac{1}{2}$   
**SCHUMACHER**  
**20-127-30**

Cervical Biopsy

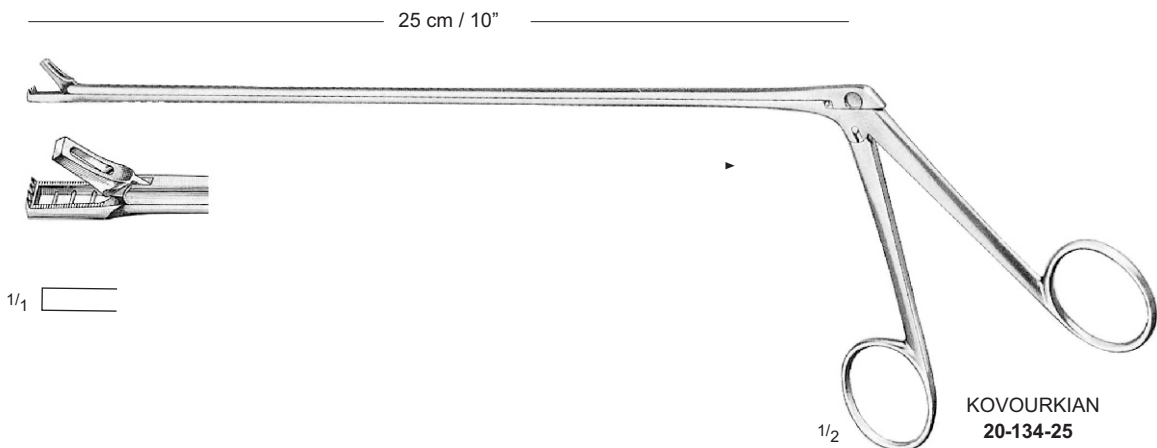
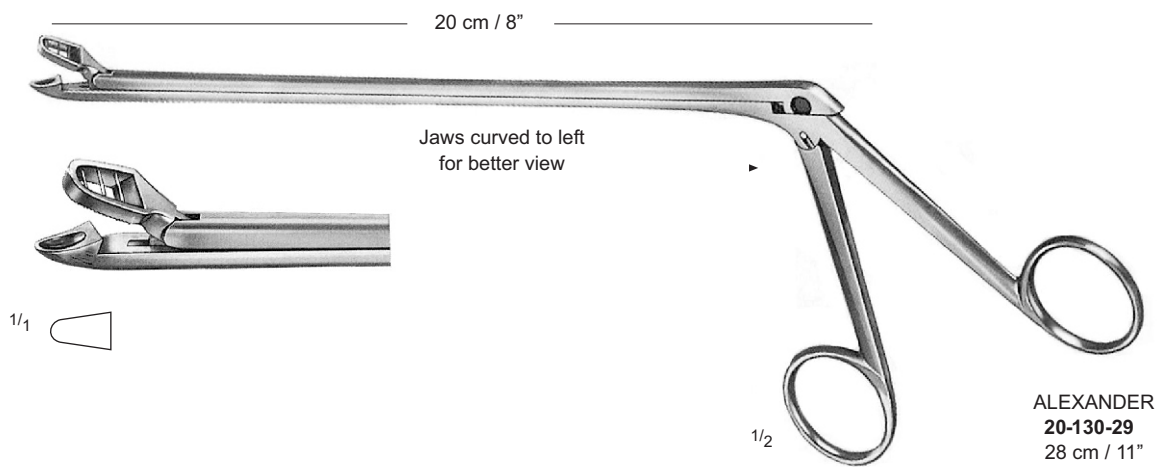
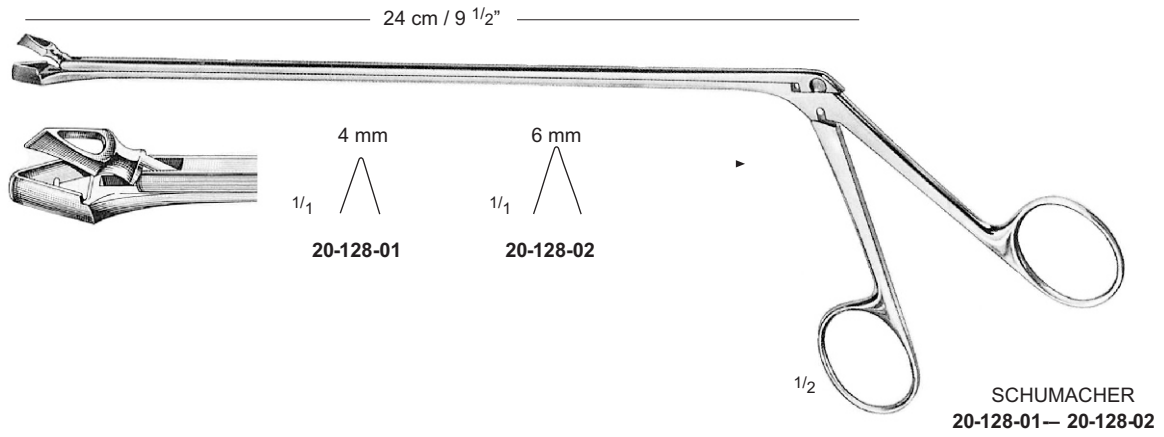

Myoma Screws, Suction Biopsy Currettes

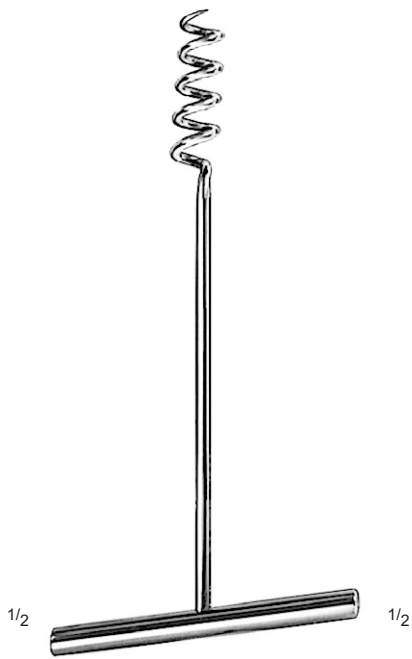

DOYEN  
 20-136-20  
 17 cm / 6 3/4"  
 ø 20 mm

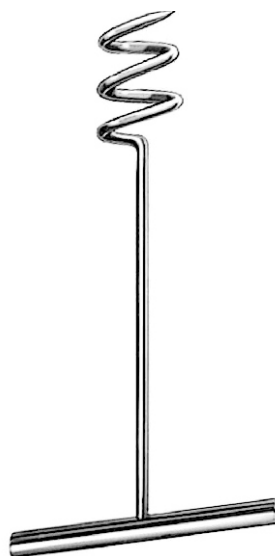

DOYEN  
 20-137-29  
 14 cm / 5 1/2"  
 ø 29 mm



NOVAK  
 20-138-23  
 23 cm / 9"

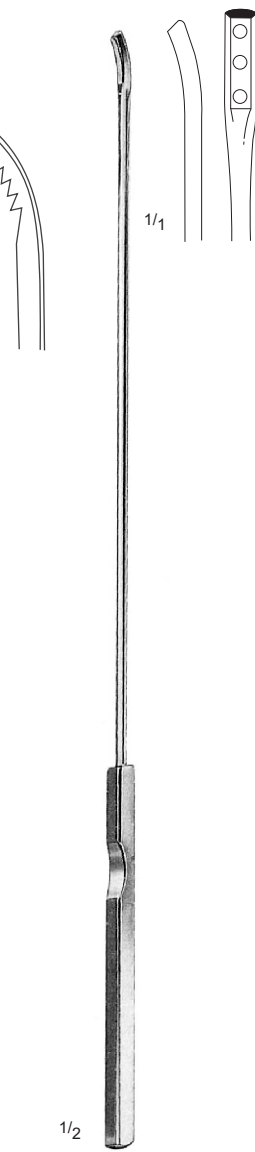

KOVOURKIAN-YOUNG  
 20-139-30  
 30 cm / 12"

Uterine Scoops



**20-146-07**  
# 1 - 7 mm



**20-148-01**  
#1 - 7 mm



**20-146-08**  
# 2 - 8 mm



**20-148-02**  
# 2 - 8 mm



**20-146-10**  
# 3 - 10 mm



**20-148-03**  
# 3 - 10 mm

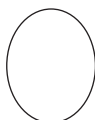

**20-146-12**  
# 4 - 12 mm



**20-148-04**  
# 4 - 11 mm

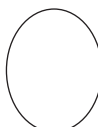

**20-146-13**  
# 5 - 13 mm



**20-148-05**  
# 5 - 12 mm

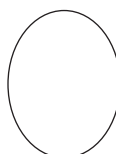

$\frac{1}{1}$   
**20-146-15**  
# 6 - 15 mm



$\frac{1}{1}$   
**20-148-06**  
# 6 - 15 mm



$\frac{1}{2}$

**SIMON**  
**20-146-07 - 20-146-15**  
29 cm / 11  $\frac{1}{2}$ "  
Rigid, Sharp



$\frac{1}{2}$

**SCHROEDER**  
**20-148-01 - 20-148-06**  
30 cm / 12"  
Rigid, Sharp

Uterine Curettes

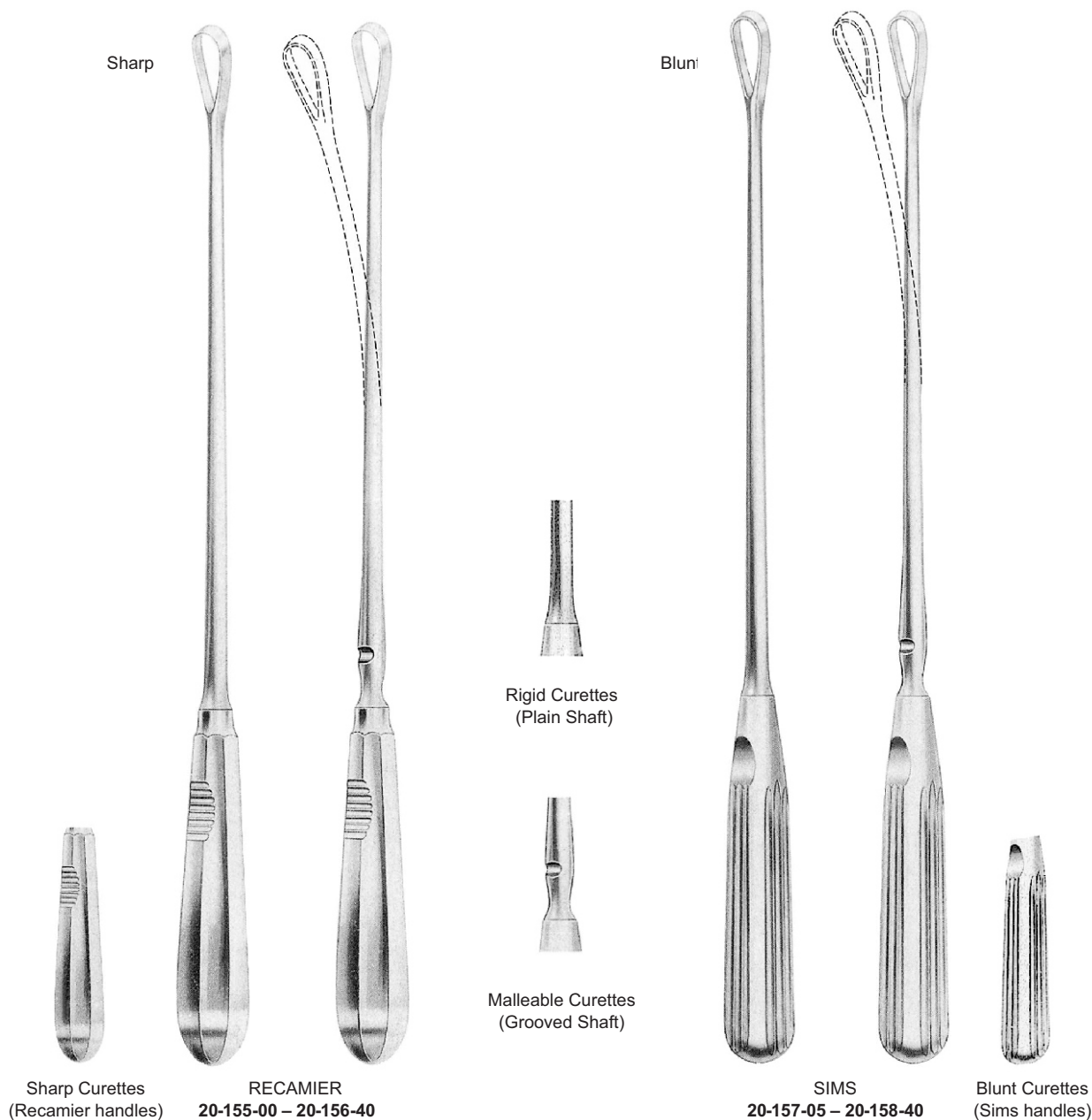

Rigid		Malleable
20-155-05	- Fig 00- 5 mm -	20-156-05
20-155-06	- Fig 0- 6 mm -	20-156-06
20-155-07	- Fig 1- 7 mm -	20-156-07
20-155-08	- Fig 2- 8 mm -	20-156-08
20-155-09	- Fig 3- 9 mm -	20-156-09
20-155-11	- Fig 4- 11 mm -	20-156-11
20-155-12	- Fig 5- 12 mm -	20-156-12
20-155-14	- Fig 6- 14 mm -	20-156-14
20-155-15	- Fig 7- 15 mm -	20-156-15
20-155-16	- Fig 8- 16 mm -	20-156-16
20-155-19	- Fig 9- 19 mm -	20-156-19
20-155-20	- Fig 10-20 mm -	20-156-20
20-155-21	- Fig 11-21 mm -	20-156-21
20-155-23	- Fig 12-23 mm -	20-156-23
20-155-25	- Fig 13-25 mm -	20-155-25
20-155-30	- Fig 14-30 mm -	20-156-30
20-155-35	- Fig 15-35 mm -	20-156-35
20-155-40	- Fig 16-40 mm -	20-156-40

Rigid		Malleable
20-157-05	- Fig 00- 5 mm -	20-158-05
20-157-06	- Fig 0- 6 mm -	20-158-06
20-157-07	- Fig 1- 7 mm -	20-158-07
20-157-08	- Fig 2- 8 mm -	20-158-08
20-157-09	- Fig 3- 9 mm -	20-158-09
20-157-11	- Fig 4- 11 mm -	20-158-11
20-157-12	- Fig 5- 12 mm -	20-158-12
20-157-14	- Fig 6- 14 mm -	20-158-14
20-157-15	- Fig 7- 15 mm -	20-158-15
20-157-16	- Fig 8- 16 mm -	20-158-16
20-157-19	- Fig 9- 19 mm -	20-158-19
20-157-20	- Fig 10-20 mm -	20-158-20
20-157-21	- Fig 11-21 mm -	20-158-21
20-157-23	- Fig 12-23 mm -	20-158-23
20-157-25	- Fig 13-25 mm -	20-158-25
20-157-30	- Fig 14-30 mm -	20-158-30
20-157-35	- Fig 15-35 mm -	20-158-35
20-157-40	- Fig 16-40 mm -	20-158-40

Uterine Curettes

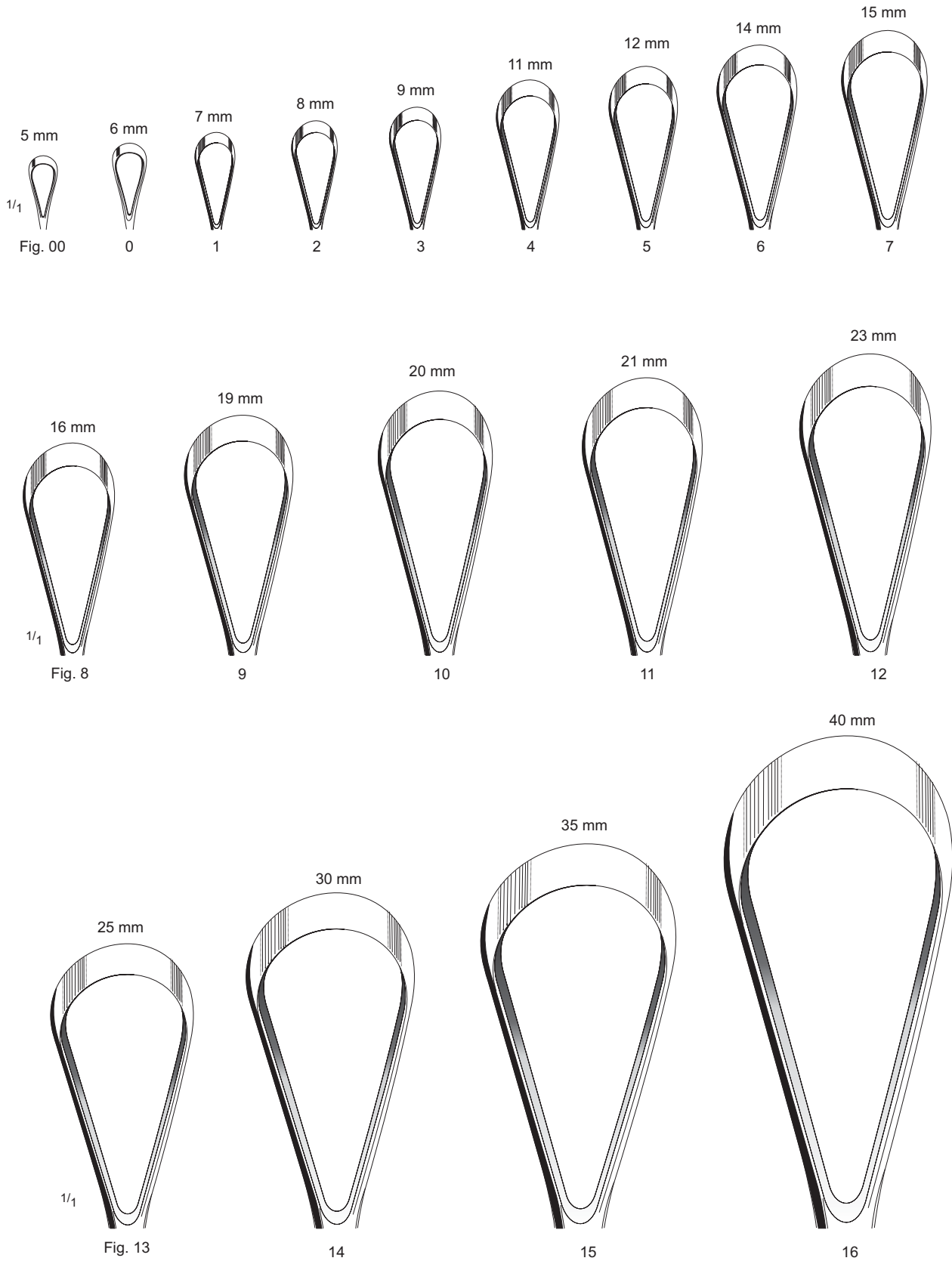

Pelvimetre, Amniotome, Scalp Flap Forceps, Obstetrical Forceps



1/4

**MARTIN**  
**20-203-35**  
 34 cm / 13 1/2"  
 cm scale



1/3

**BEACHAM**  
**20-206-24**  
 24 cm / 9 1/2"

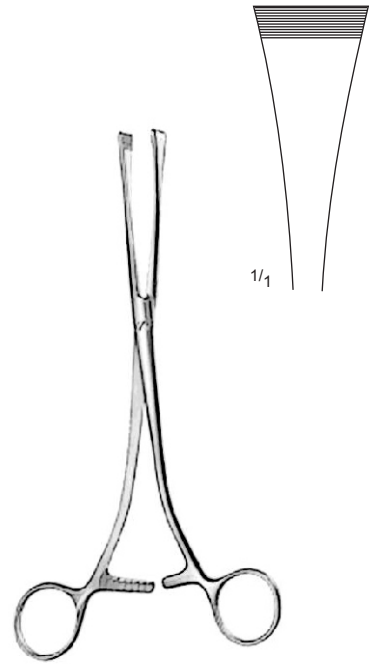

1/3

**GREEN ARMYTAGE**  
**20-209-22**  
 22 cm / 8 3/4"



1/4

**DeLEE**  
**20-212-36**  
 36 cm / 14 1/4"

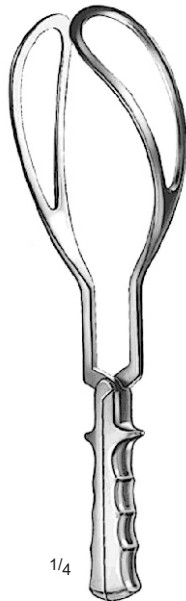

1/4

**SIMPSON**  
**20-213-32** – 32 cm / 12 1/2"  
**20-213-36** – 36 cm / 14 1/4"

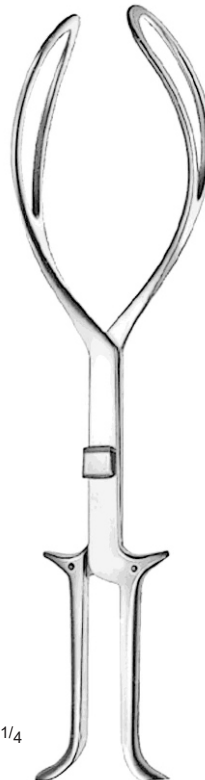

1/4

**KIELLAND**  
**20-217-40**  
 40 cm / 15 3/4"

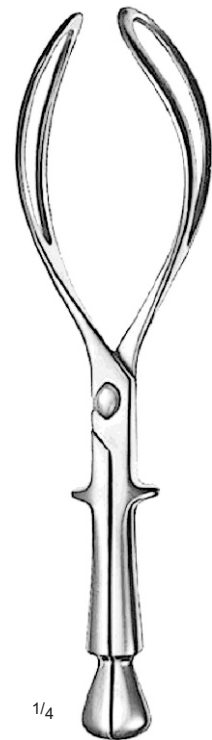

1/4

**NAEGELE**  
**20-223-35** – 36 cm / 14"  
**20-223-40** – 40 cm / 15 3/4"

Episiotomy Scissors, Umbilical Cord Scissors

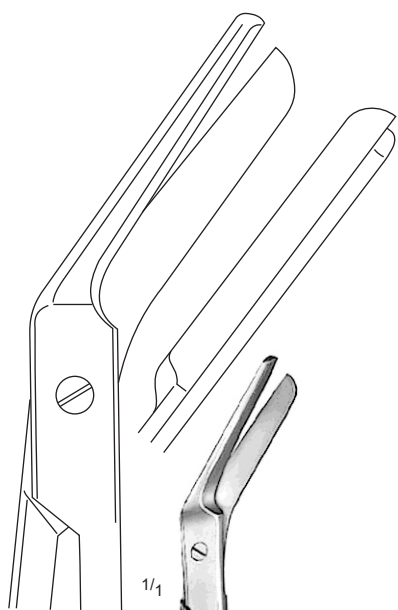

1/1

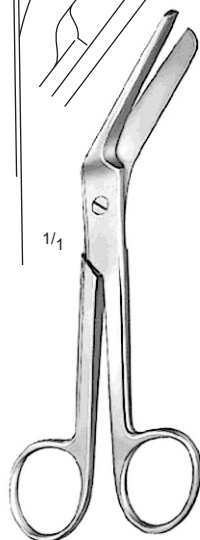

1/3

**BRAUN STADLER**  
**20-220-15**  
 15 cm / 6"



1/1

1/3



**BRAUN STADLER**  
**20-220-21**  
 21 cm / 8 1/4"

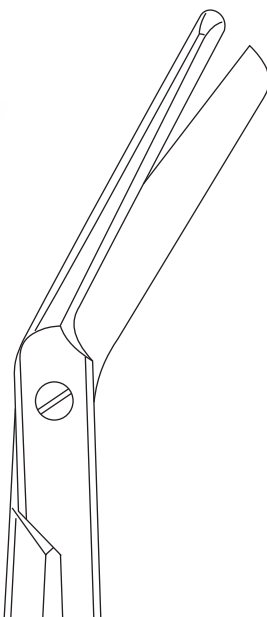

1/1

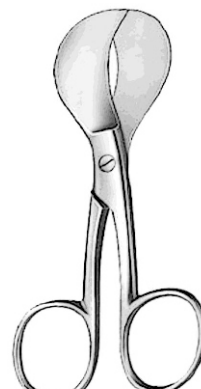

1/3

**USA PATTERN**  
**20-232-11**  
 10.5 cm / 4 1/4"

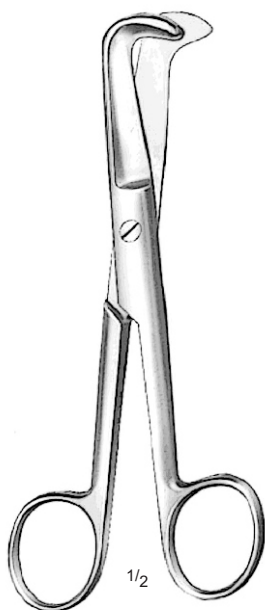

1/2

**SCHUMACHER**  
**20-233-16**  
 16 cm / 6 1/4"

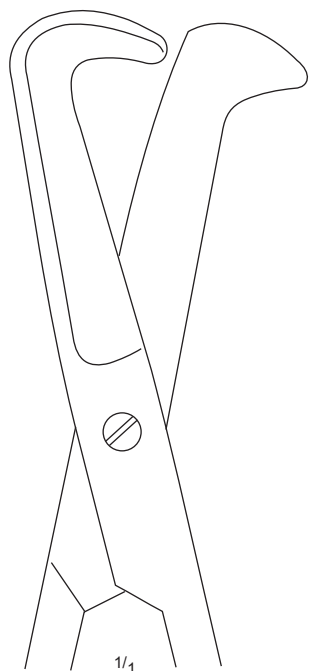

1/1

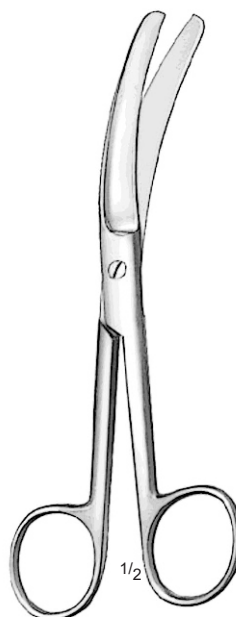

1/2

**BUSCH**  
**20-234-16**  
 16 cm / 6 1/4"

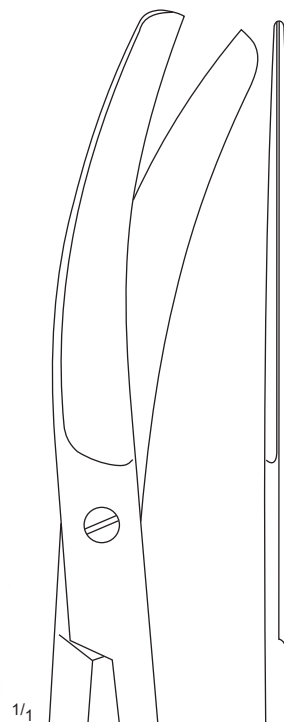

1/1



Elevating Spoon, Cord Clamps, Placenta Forceps



1/4

**SELHEIM**  
**20-225-28**  
 28 cm / 11"

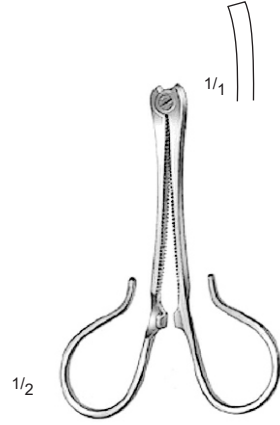

1/2

**KANE**  
**20-235-09**  
 8.5 cm / 3 1/2"



1/2

**COLLIN**  
**20-236-09**  
 9 cm / 3 1/2"

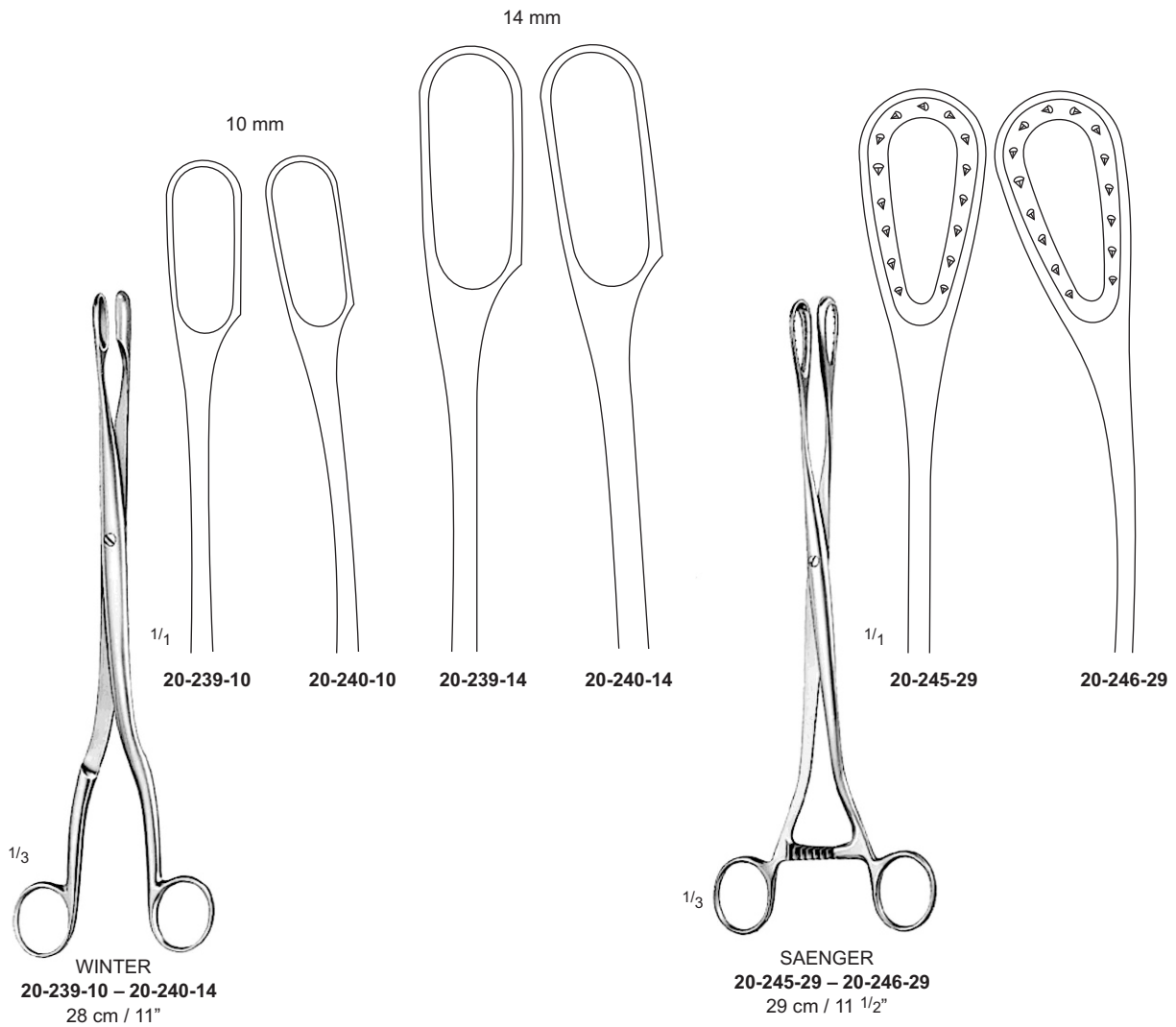

1/3

**WINTER**  
**20-239-10 – 20-240-14**  
 28 cm / 11"

1/3

**SAENGER**  
**20-245-29 – 20-246-29**  
 29 cm / 11 1/2"