

ORTHOPEDIC



Mallets



20 mm ø
 140 g (5 oz)

1/2
21-001-16
 16.5 cm / 6 1/2"



40 mm ø
 690 g
 (1 1/2" lbs)

1/2
KIRK
21-002-20
 20 cm / 8"



30 mm & 42 mm ø
 530 g 1lb. 3 oz)

1/2
21-005-24
 24 cm / 9 1/2"

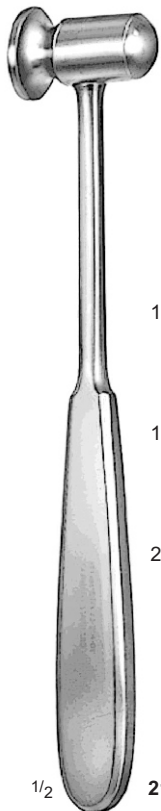

21-003-25
 25m ø
 120 g (4 1/4 oz)

21-003-30
 30m ø
 180 g (6 1/4 oz)

21-003-35
 35m ø
 260 g (9 1/4 oz)

1/2
DOYEN
21-003-01 – 21-003-03
 21 cm / 8 1/4"

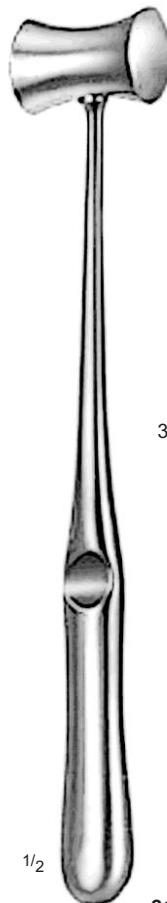

21-004-26
 26m ø
 300 g (10 1/4 oz)

21-004-28
 28m ø
 340 g (12 oz)

21-004-30
 30m ø
 400 g (14 oz)

1/2
WILLIGER
21-004-01 – 21-004-03
 24 cm / 9 1/2"



30 mm ø
 220 gm
 (7 1/2 oz)

1/2
COLLIN
21-006-20
 20 cm / 8"

Mallets

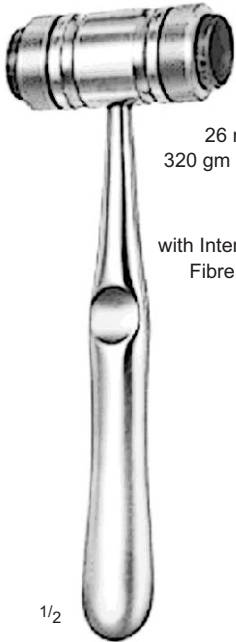

26 mm ø
320 gm (11 1/2 oz)

with Interchangeable
Fibre Facings

1/2

MEAD
21-007-18
18 cm / 7"



30 mm ø
400 gm (14 oz)

1/2

GERZOG
21-008-18
18 cm / 7"

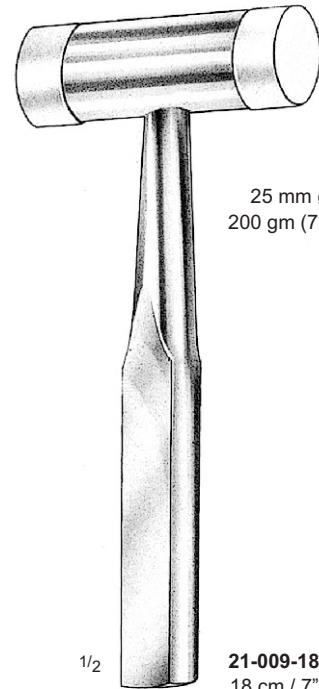

25 mm ø
200 gm (7 oz)

1/2

21-009-18
18 cm / 7"

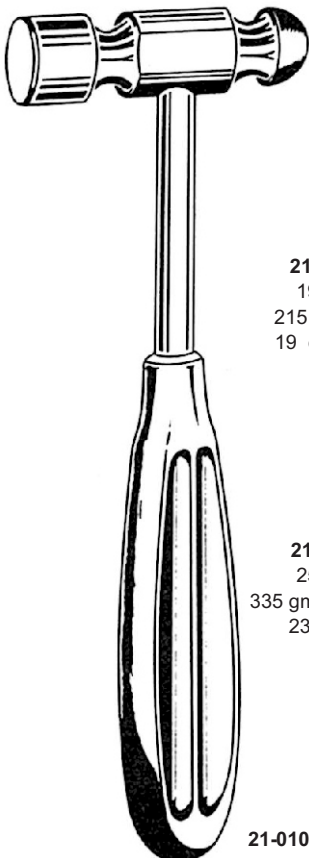

21-010-19
19 mm ø
215 gm (7 oz)
19 cm / 7 1/2"

21-010-25
25 mm ø
335 gm (11 1/2 ozs)
23 cm - 9"

21-010-19 - 21-010-25

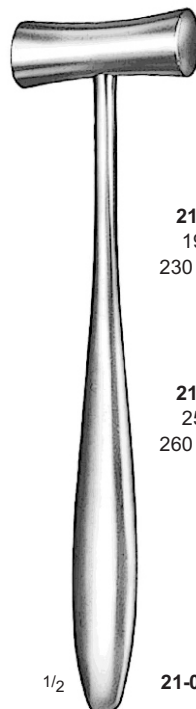

21-011-19
19 mm ø
230 gm (8 oz)

21-011-25
25 mm ø
260 gm (9 oz)

1/2

LUCAE
21-011-19 - 21-011-25
19 cm 7 1/2"



30 mm ø
510 gm
(18 oz)

1/3

21-012-26
26 cm 10 1/2"

Bone Rasps & Files

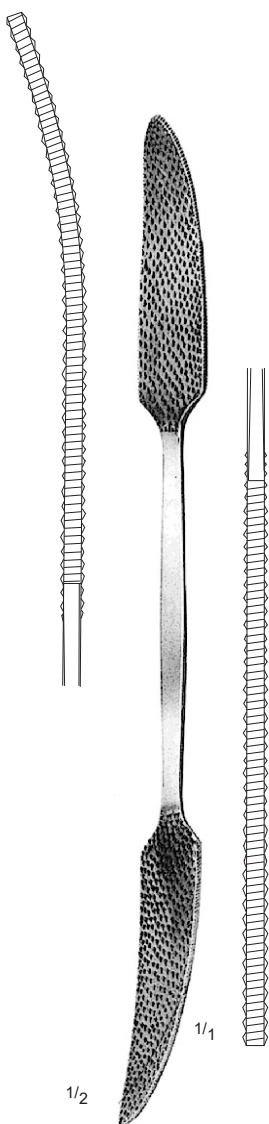

PUTTI
 21-104-28
 28 cm / 11"

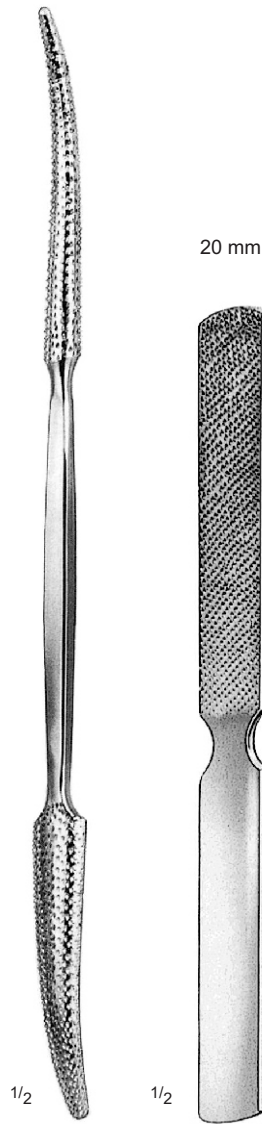

PUTTI
 21-105-30
 30 cm / 12"

20 mm



21-106-22
 22 cm / 8 3/4"

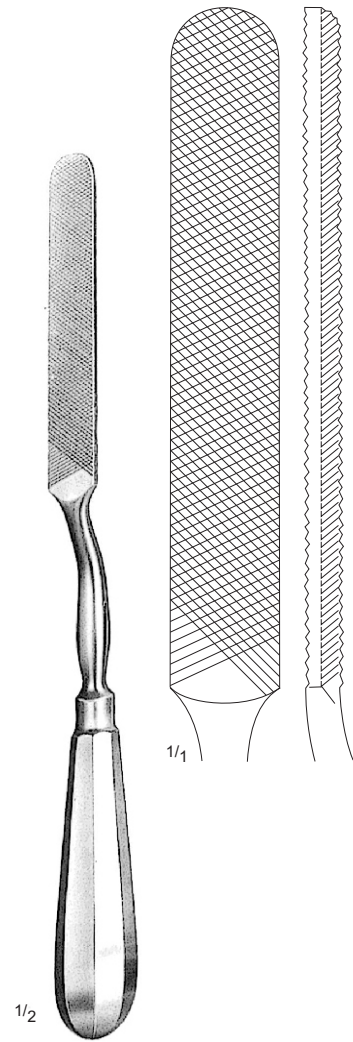

21-108-24
 24 cm / 9 1/2"

Periosteal Elevators, Raspatories

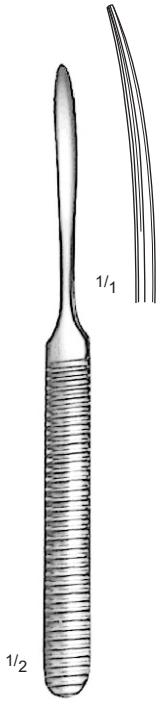

WILLIGER
21-111-17
 17 cm / 6 3/4"

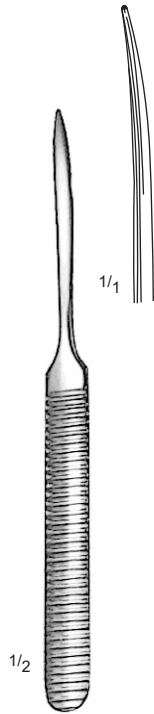

WILLIGER
21-112-16
 16 cm / 6 1/4"



LANGENBECK
21-113-05 – 21-113-10

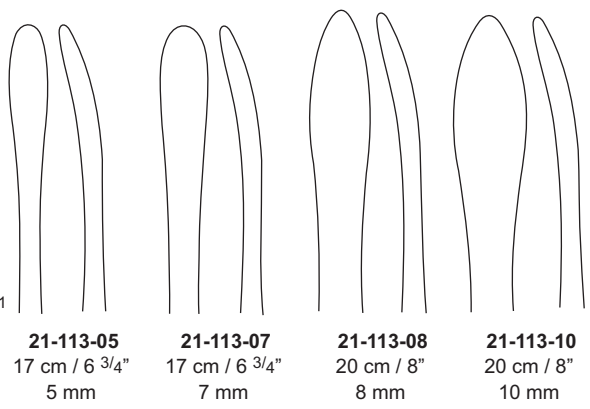

21-113-05
 17 cm / 6 3/4"
 5 mm

21-113-07
 17 cm / 6 3/4"
 7 mm

21-113-08
 20 cm / 8"
 8 mm

21-113-10
 20 cm / 8"
 10 mm

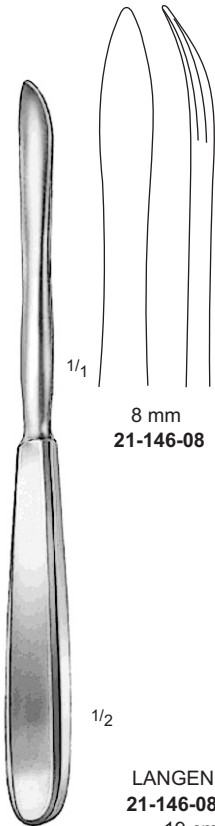

LANGENGENBECK
21-146-08 – 21-146-10
 19 cm / 7 1/2"

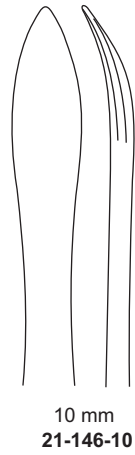

8 mm
21-146-08

10 mm
21-146-10



HOEN
21-114-07 – 21-114-20

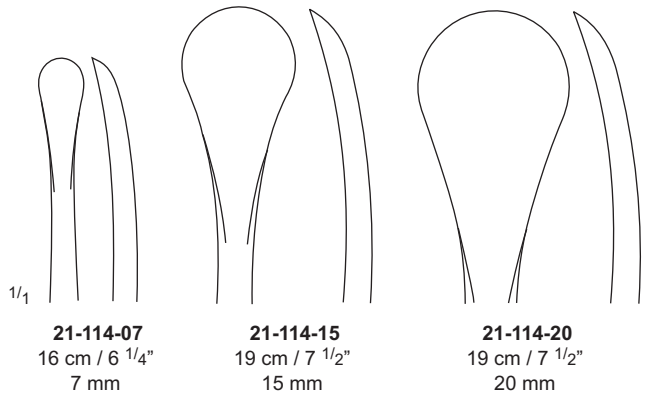

21-114-07
 16 cm / 6 1/4"
 7 mm

21-114-15
 19 cm / 7 1/2"
 15 mm

21-114-20
 19 cm / 7 1/2"
 20 mm

Periosteal Raspatories, Dissectors, Elevators

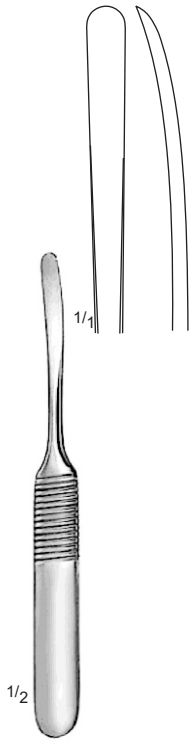

WILLIGER
21-015-13
 13 cm / 5"

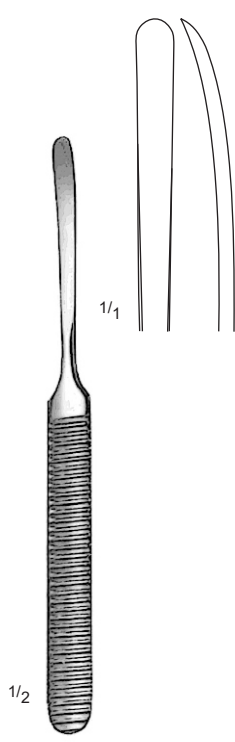

WILLIGER
21-016-16
 16 cm / 6 1/4"

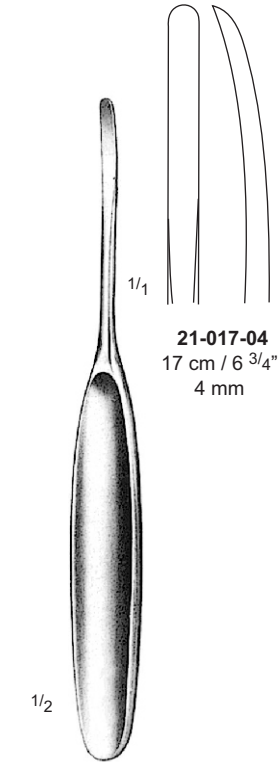

CUSHING
21-017-01— 21-016.04

21-017-04
 17 cm / 6 3/4"
 4 mm

21-017-02
 17 cm / 6 3/4"
 6 mm

21-017-5
 19.5 cm / 7 3/4"
 5 mm

21-017-7
 19.5 cm / 7 3/4"
 7 mm



McDONALD
21-018-19
 19 cm / 7 1/2"

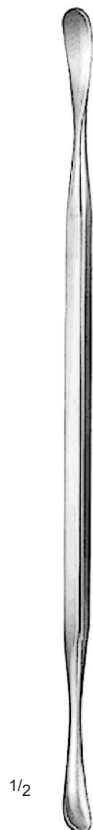

ALDERDYCE
21-018-21
 21 cm / 8 1/4"

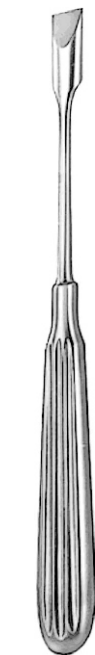

ADSON
21-026-17
 17 cm / 6 3/4"



SEDILOT
21-028-21
 21 cm / 8 1/4"



Periosteal Raspatories

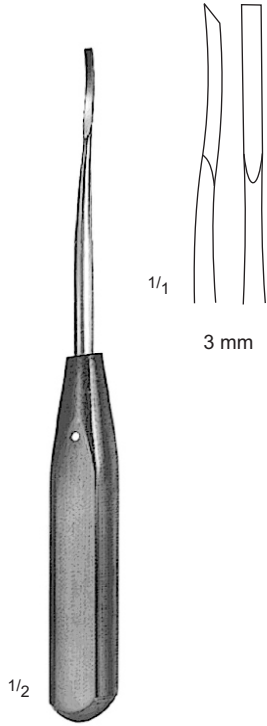

21-029-03
 18.5 cm / 7 1/4"

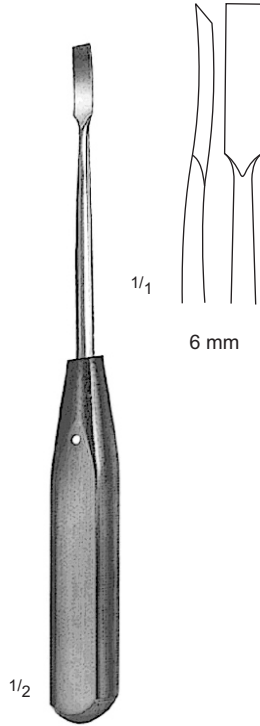

21-029-06
 18.5 cm / 7 1/2"

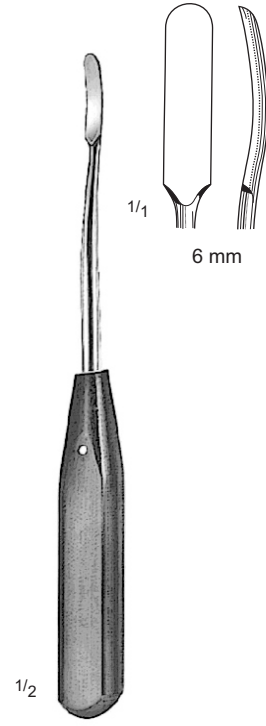

21-030-06
 18.5 cm / 7 1/2"

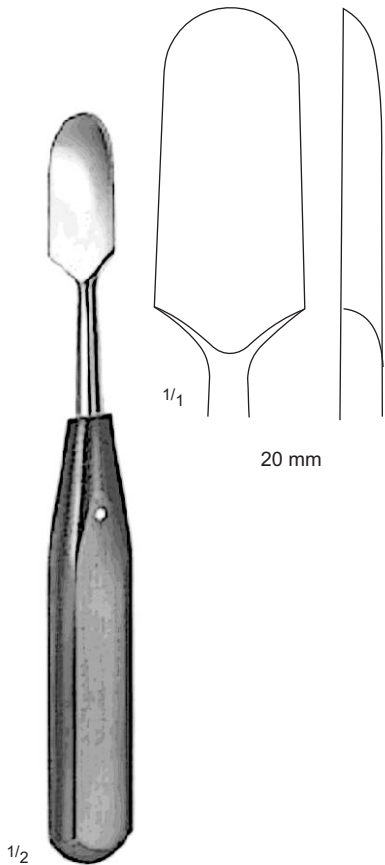

21-031-20
 20 cm / 8"

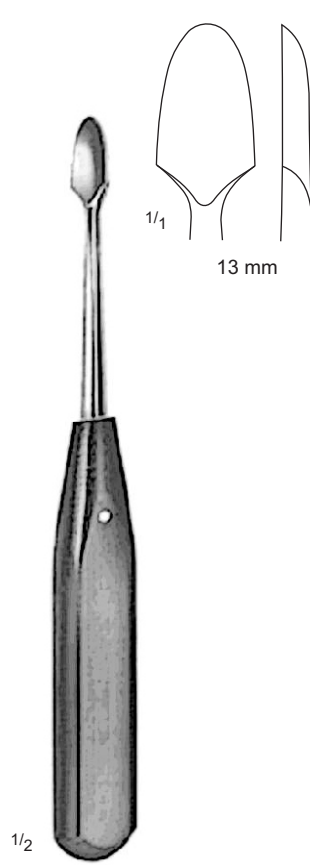

21-033-13
 20 cm / 8"

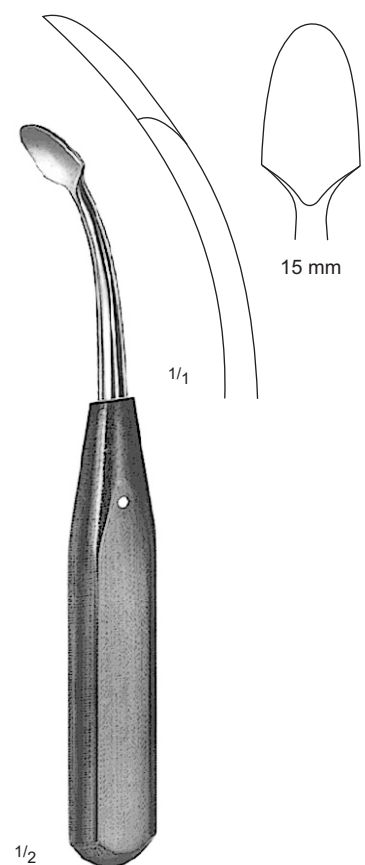

21-033-15
 20 cm / 8"

Periosteal Raspatories, Bone Levers

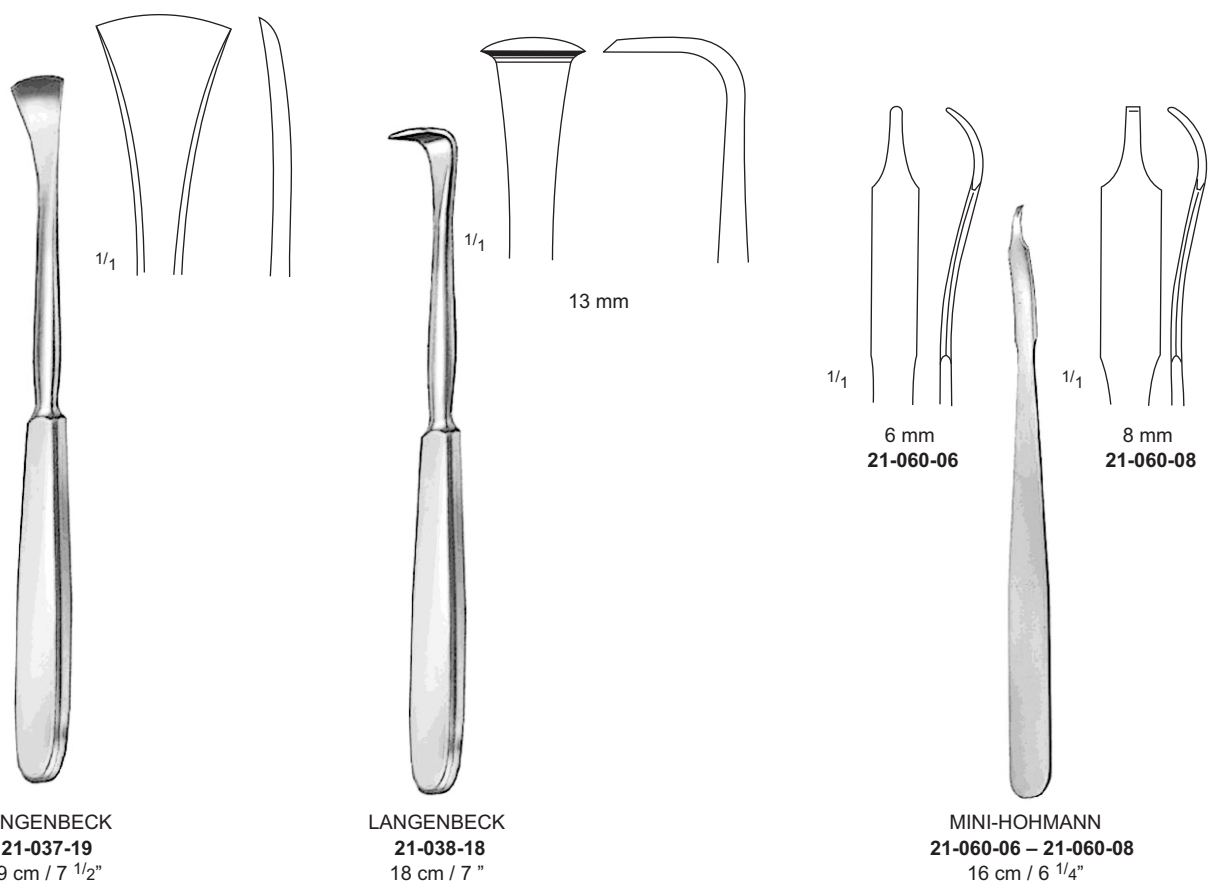
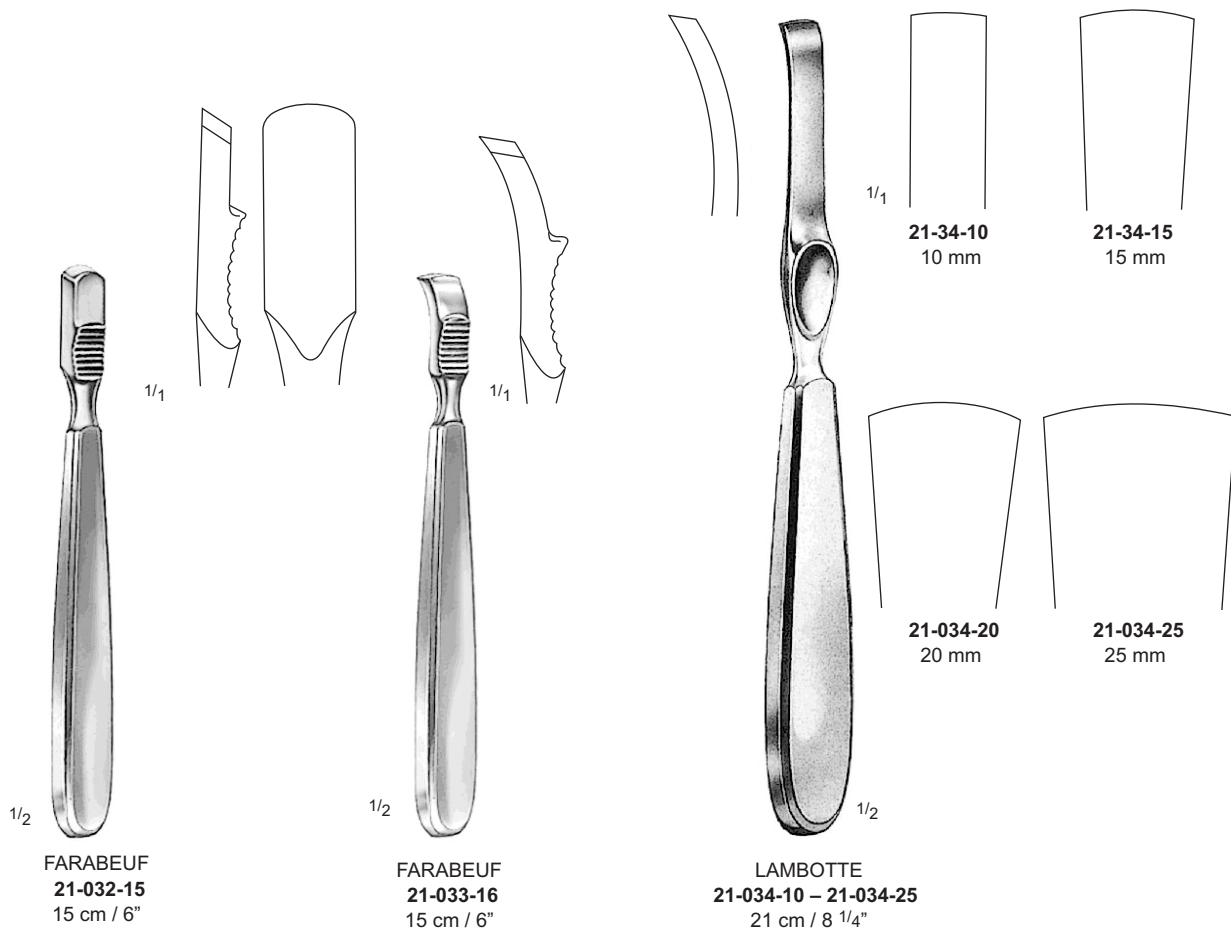

Bone Levers



HOHMANN

21-062-08
22 cm / 8 3/4"

21-062-18
24 cm / 9 1/2"

21-062-43
24 cm / 9 1/2"

21-062-70
29 cm / 11 1/2"

Bone Levers



HOHMANN

LANGE-HOHMANN

21-064-22
 25 cm / 10"

21-064-24
 28 cm / 11"

21-064-33
 29 cm / 11 1/2"

21-064-43
 24 cm / 9 1/2"

21-066-22
 26 cm / 10 1/4"

Bone Cutting Forceps



21-103-23
 23 cm / 9"



CLEVELAND
21-105-15
 15 cm / 6"

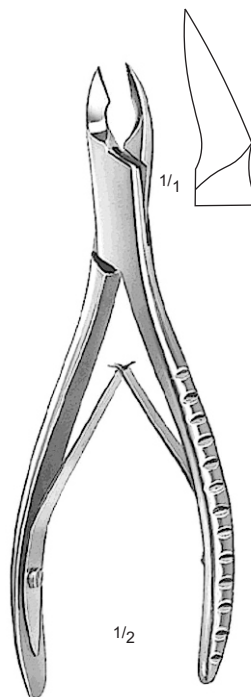

CLEVELAND
21-105-17
 17 cm / 6 3/4"

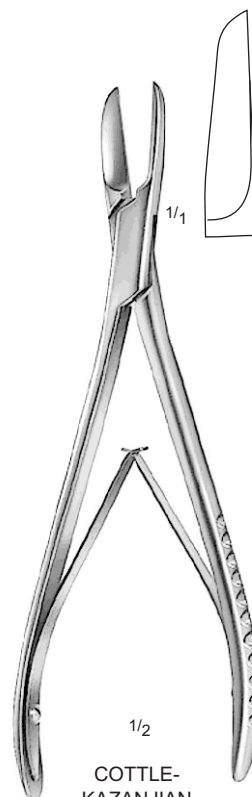

**COTTLE-
 KAZANJIAN**
21-107-18
 18 cm / 7"



21-110-14
 14 cm / 5 1/2"



21-110-17
 17 cm / 6 3/4"

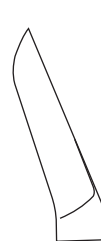

21-111-14
 14 cm / 5 1/2"



21-111-17
 17 cm / 6 3/4"

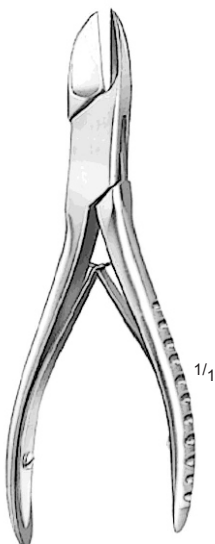

21-110-19
 19 cm / 7 1/2"

LISTON
 21-110-14 – 21-110-22



21-110-22
 22 cm / 8 3/4"



LISTON
 21-111-14 – 21-111-22

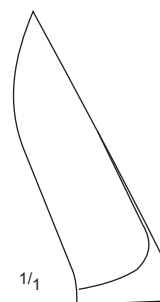

21-111-19
 19 cm / 7 1/2"

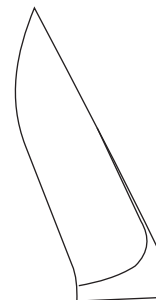

21-111-22
 22 cm / 8 3/4"

Bone Holding Clamps

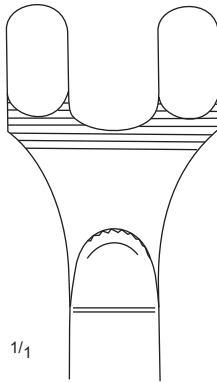
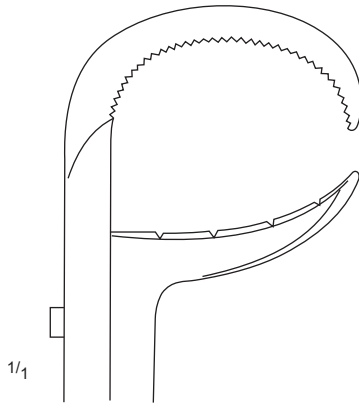
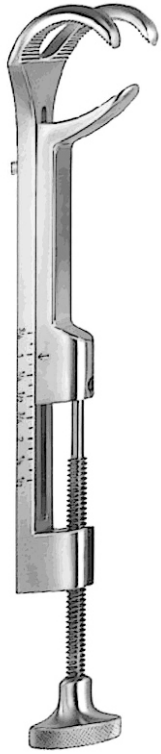

21-135-18
 18 cm / 7"

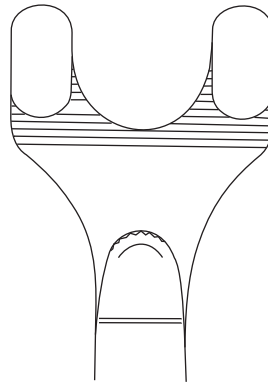

21-135-20
 20 cm / 8"

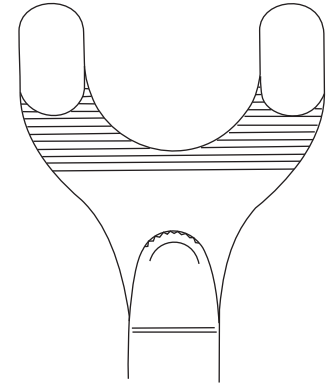

21-35-22
 22 cm / 8 3/4"

GERSTER-LOWMAN
 21-135-18 – 21-135-22

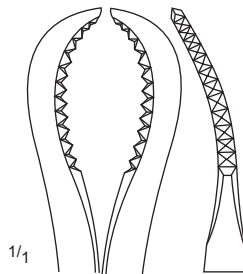
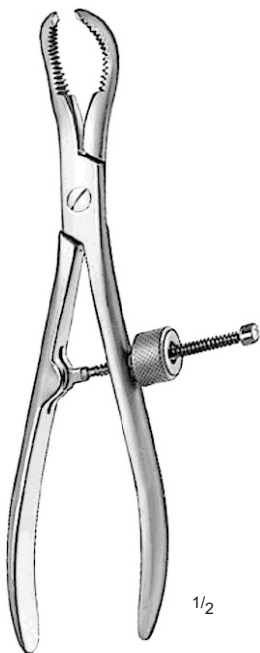

21-141-16
 16 cm / 6 1/4"

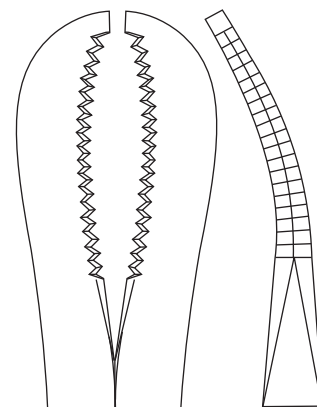

21-142-22
 22 cm / 8 3/4"

21-141-16 – 21-141-22

Bone Cutting Forceps

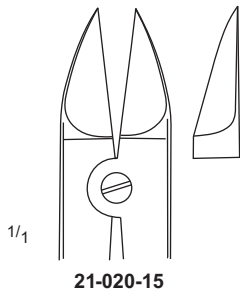

21-020-15

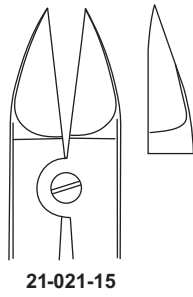

21-021-15

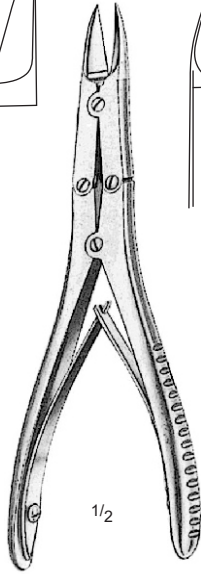

LISTON MINI
 21-020-15 – 21-021-15
 15 cm / 6"

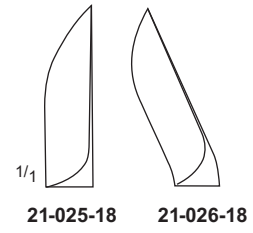
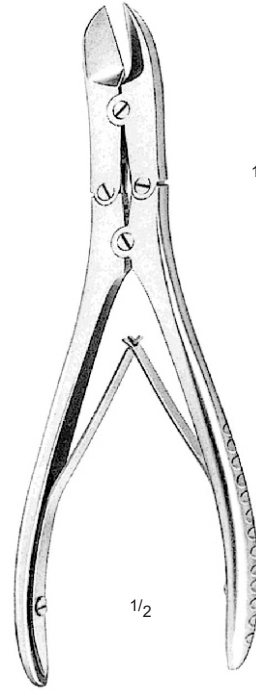

21-025-18 21-026-18

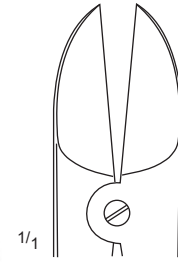

RUSKIN LISTON
 21-025-18 – 21-026-18
 18 cm / 7"

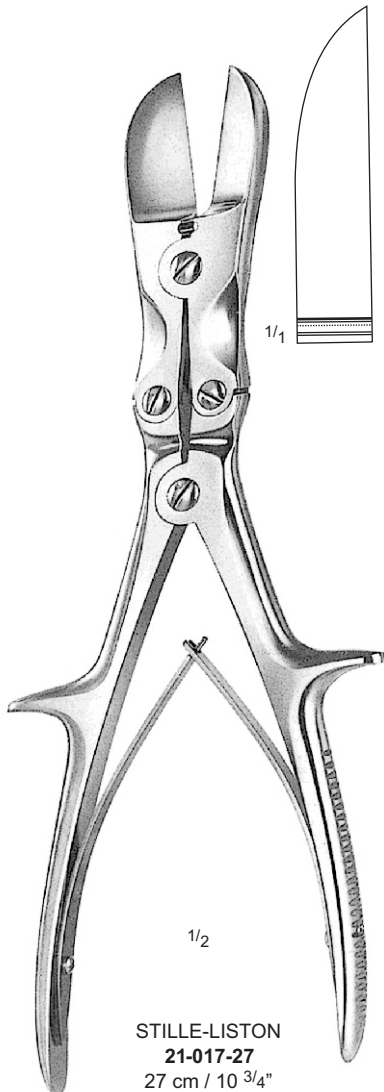

STILLE-LISTON
 21-017-27
 27 cm / 10 3/4"

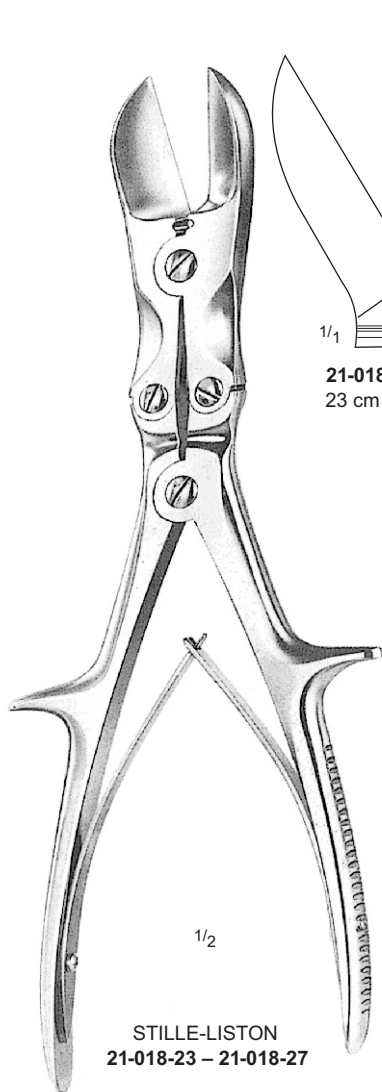

STILLE-LISTON
 21-018-23 – 21-018-27

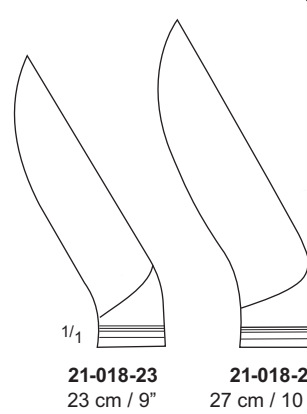

21-018-23
 23 cm / 9"

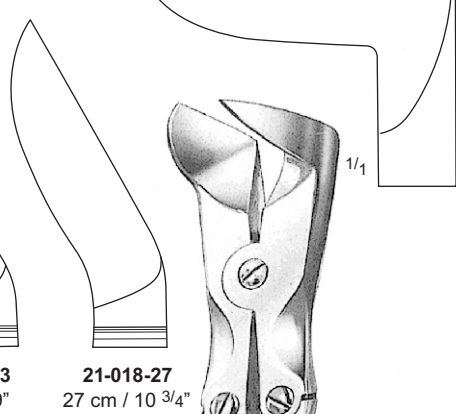

21-018-27
 27 cm / 10 3/4"

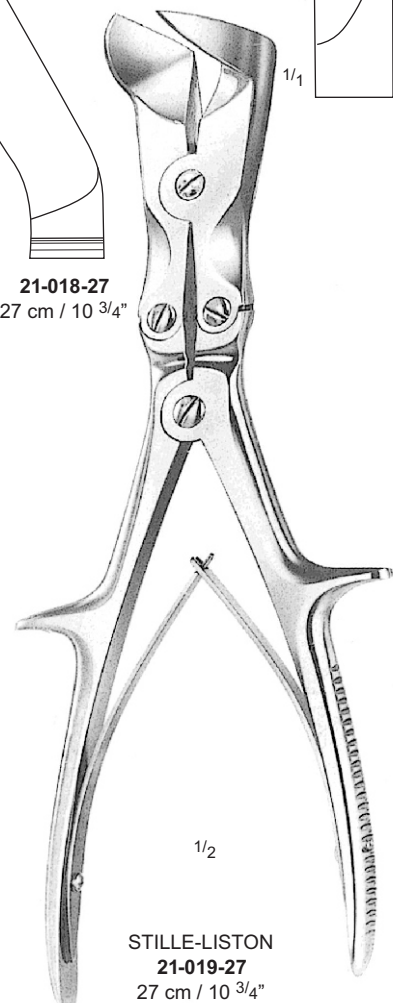

STILLE-LISTON
 21-019-27
 27 cm / 10 3/4"

Bone Holding Forceps

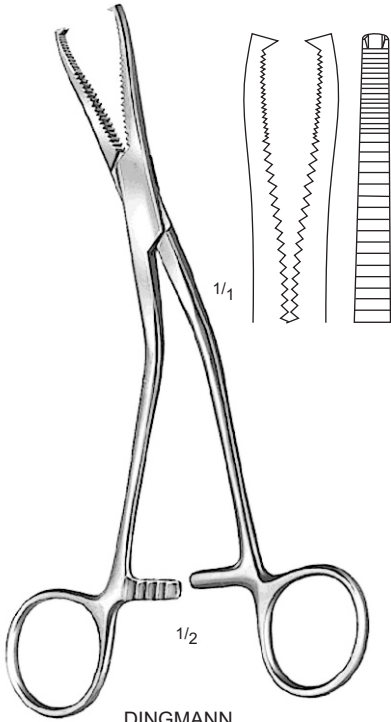

DINGMANN
21-038-19
 19 cm / 7 1/2"

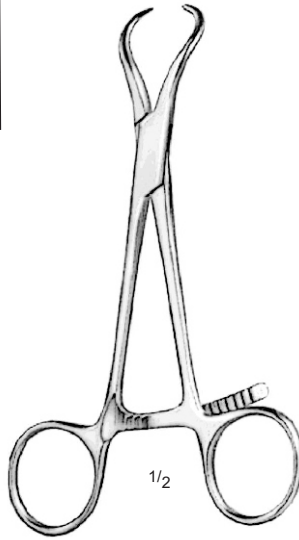

21-047-14
 14 cm / 5 1/2"

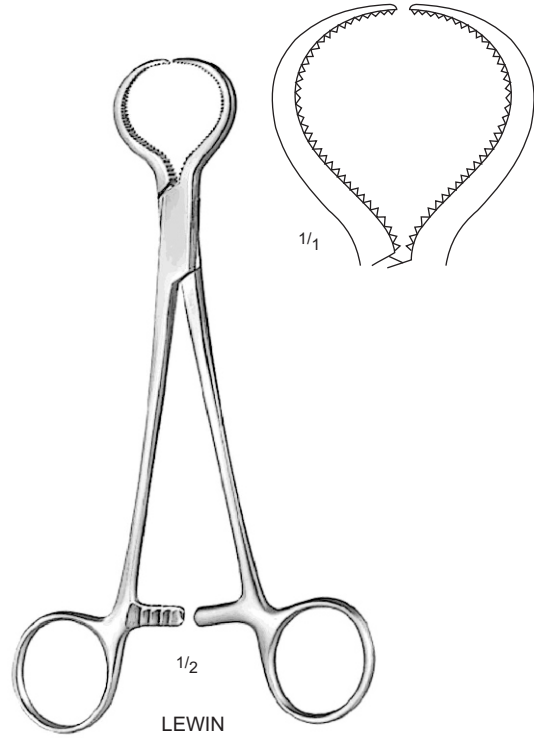

LEWIN
21-048-18
 18 cm / 7"

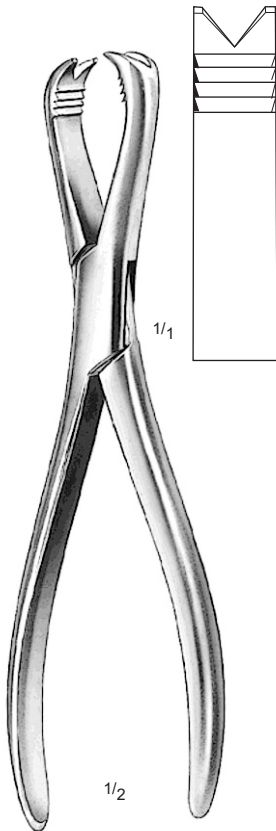

LANGENBECK
21-051-21
 21 cm / 8 1/4"

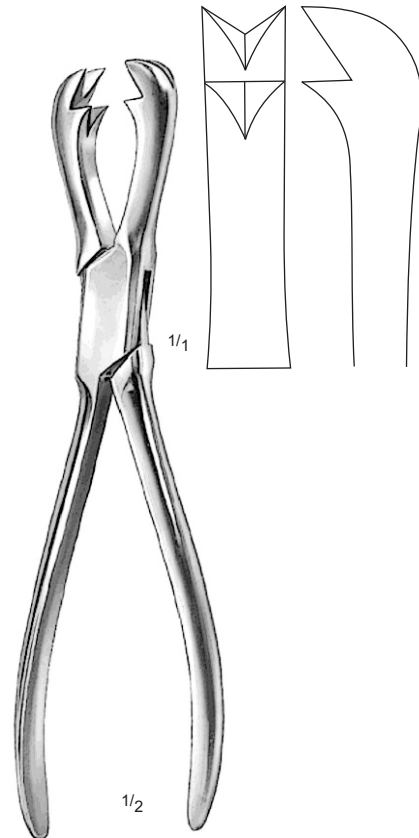

FERGUSON
21-052-21
 21 cm / 8 1/4"

Bone Holding Forceps

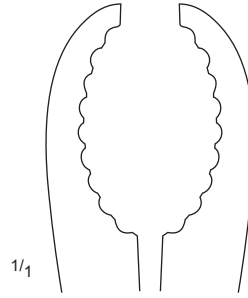
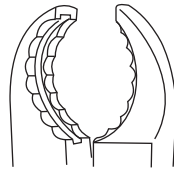
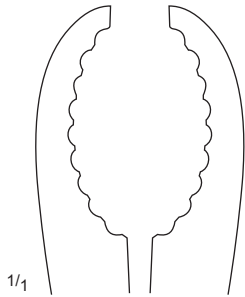

21-055-23
 21-056-24
 23 cm / 9"

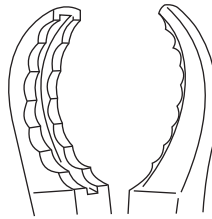

21-055-25
 21-056-26
 25 cm / 10"

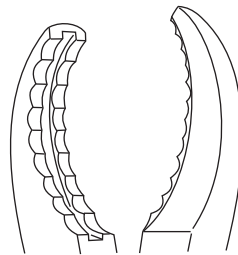

21-055-28
 21-056-29
 28 cm / 11"

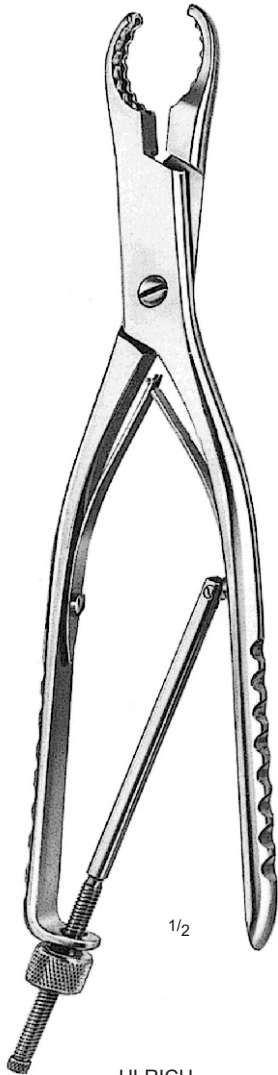
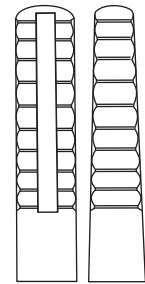

ULRICH
 21-055-23 – 21-055-28

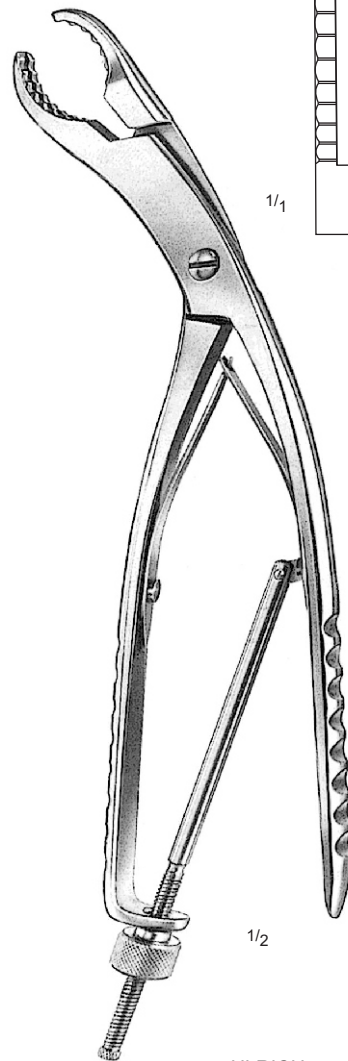

ULRICH
 21-056-24 – 21-056-29

Bone Holding Forceps

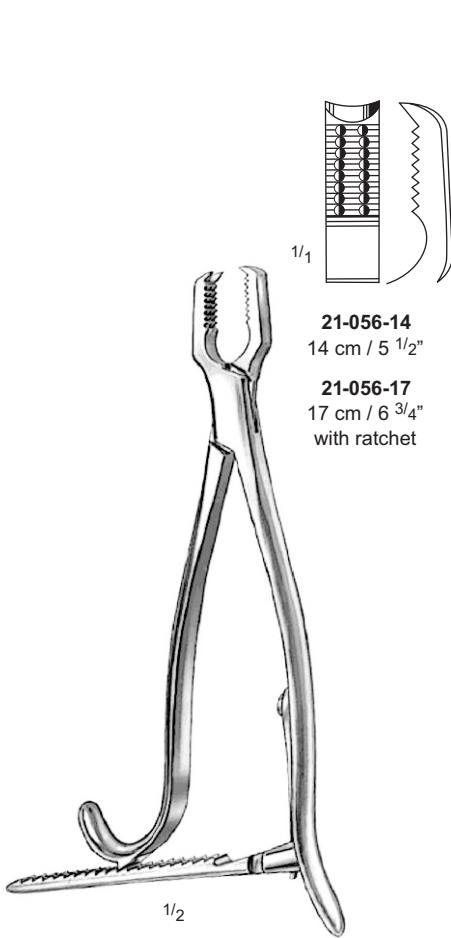

21-056-14
 14 cm / 5 1/2"
21-056-17
 17 cm / 6 3/4"
 with ratchet

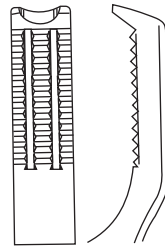

21-056-21
 21 cm / 8 1/4"
 with ratchet

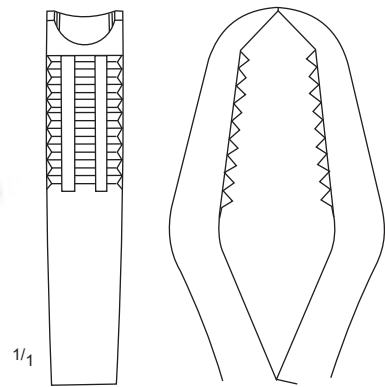

21-058-33
 33 cm / 13"

21-058-45
 45 cm / 17 3/4"
 without ratchet

21-059-33
 33 cm / 13"

21-059-45
 45 cm / 17 3/4"
 with ratchet

KERN
 21-057-14 – 21-057-21



LANE
 21-058-33 – 21-059-45

Bone Holding Forceps

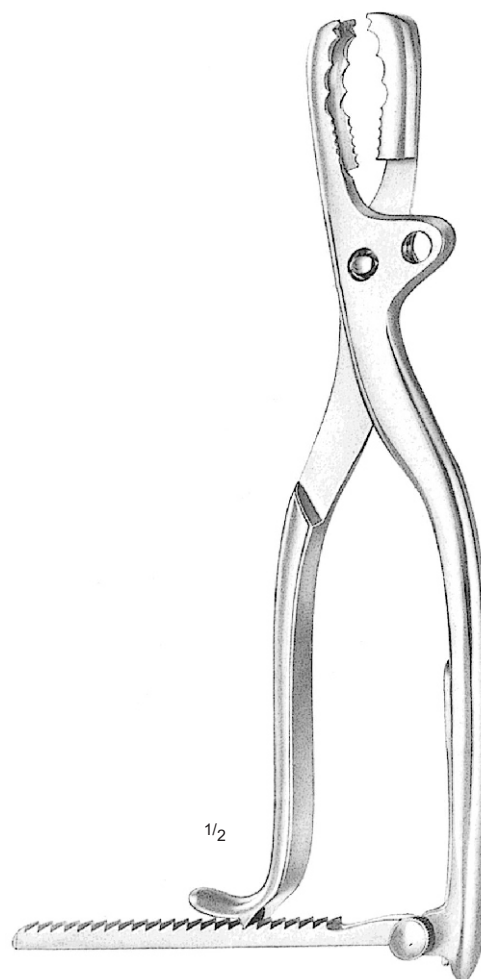
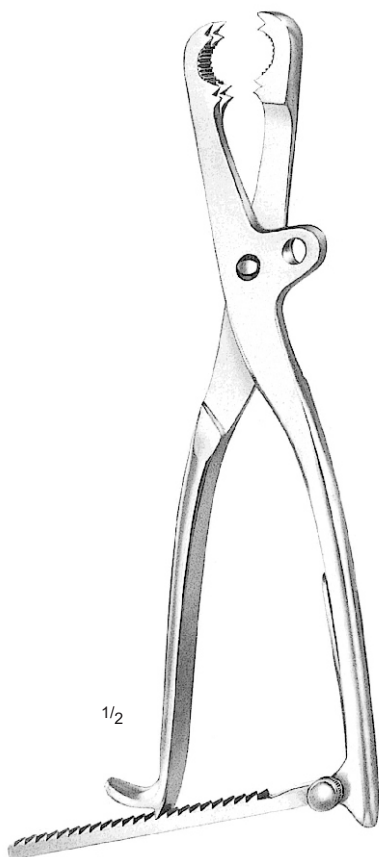
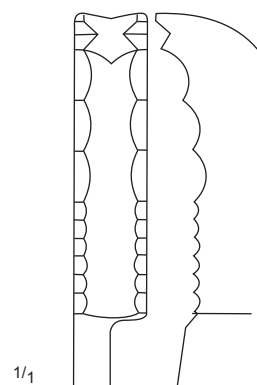
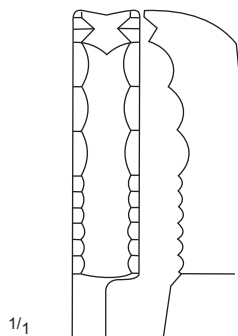
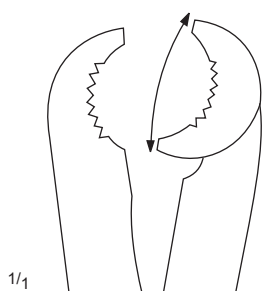

LAMBOTTE
 21-062-21 – 21 cm / 8 1/4"
 21-062-25 – 25 cm / 10"
 21-062-30 – 30 cm / 12"

FARABEU
 21-064-23 – 23 cm / 9"
 21-064-25 – 25 cm / 10"

FARABEU - LAMBOTTE
 21-065-26
 26 cm / 10 1/4"

Bone Holding Forceps

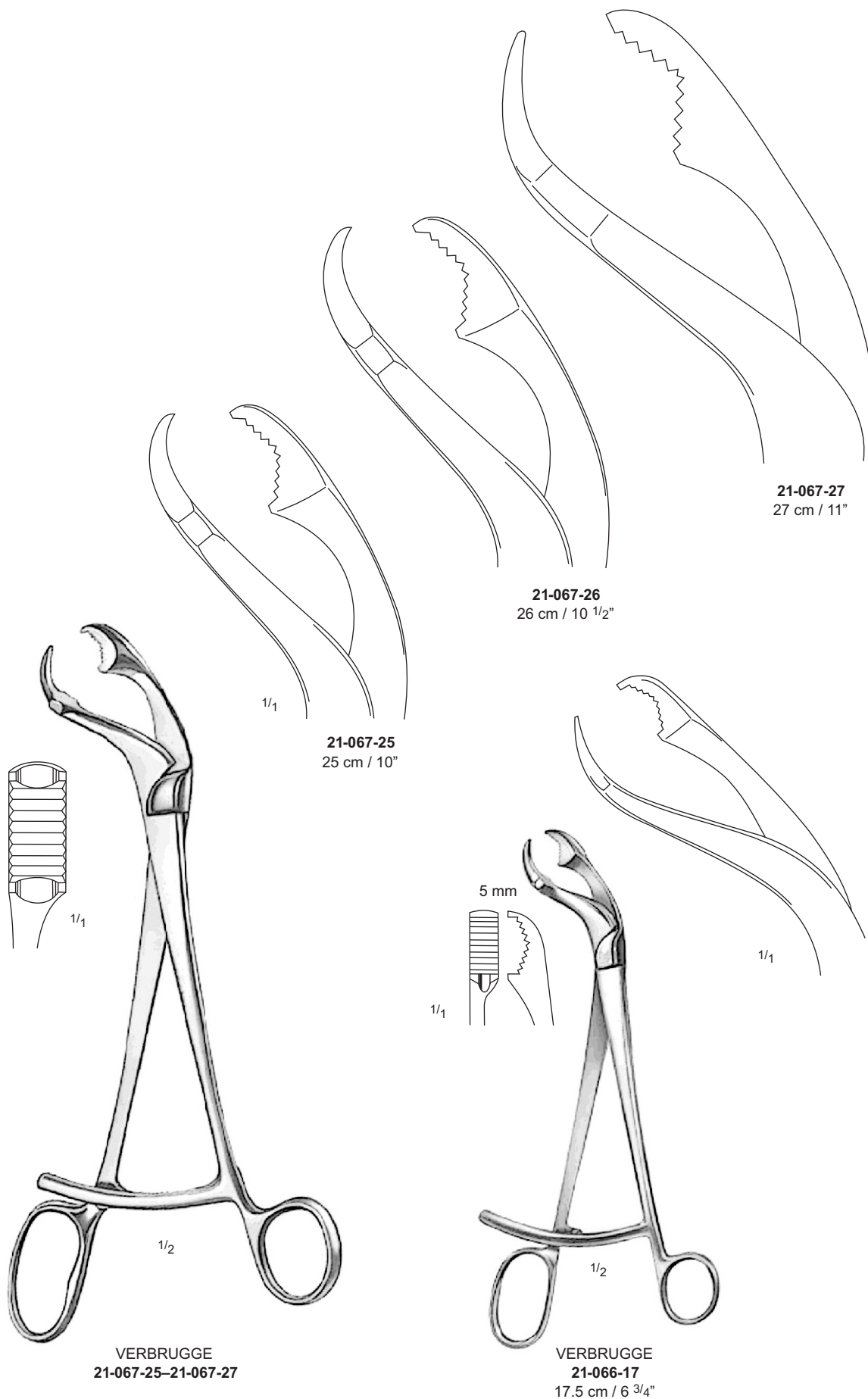

Amputating Saws, Wire Saws, Wire Saw Handles



1/3

LANGENBECK
21-070-23
23 cm / 9"



1/3

CHARRIERE
21-071-27 – 27 cm / 10 ³/₄"
Blade Length 15 cm / 6"

21-071-30 – 30 cm / 12"
Blade Length 20 cm / 8"

21-071-34 – 34 cm / 13 ¹/₂"
Blade Length 25 cm / 10"



1/4

SATERLEE
21-072-29
29 cm / 11 ¹/₂"
Blade Length 21 cm / 8 ¹/₄"



1/4

CHARRIERE
21-073-35
35 cm / 14"



GIGLI
21-074-30 – 30 cm / 12"
21-074-40 – 40 cm / 15 ³/₄"
21-074-50 – 50 cm / 19 ³/₄"
21-074-60 – 60 cm / 23 ³/₄"
21-074-70 – 70 cm / 27 ¹/₂"



GIGLI
21-074-02
(Pair of Handles)



Wire Holder
21-075-20
Aluminium 20 cm

Flat Nose Pliers, Wire Cutting Pliers, with Tungsten Carbide, T/C Inserts

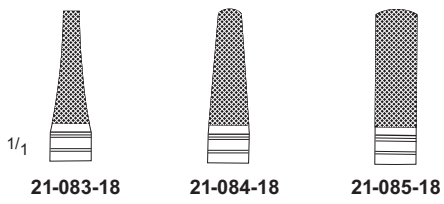

with Tungsten Carbide, T/C

21-083-18 – 21-085-18
 18 cm / 7"

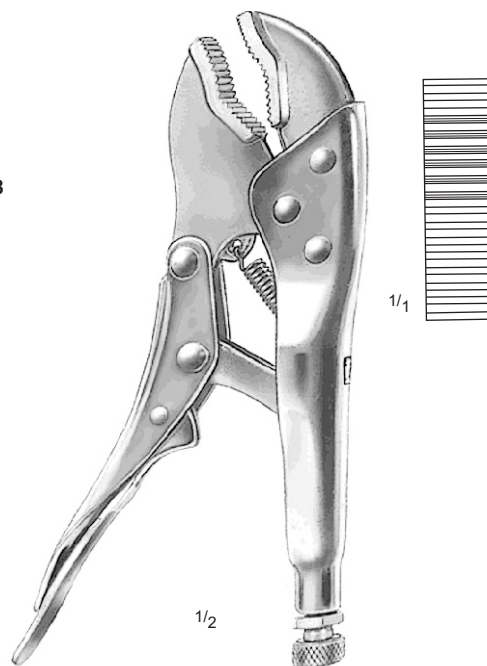

21-088-18
 18 cm / 7"

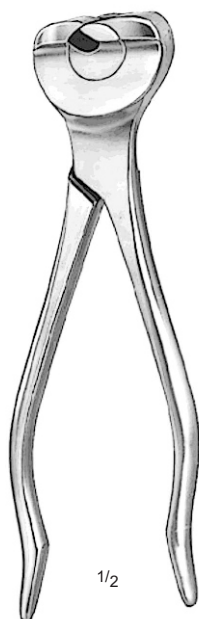

21-092-16
 16 cm / 6 1/4"

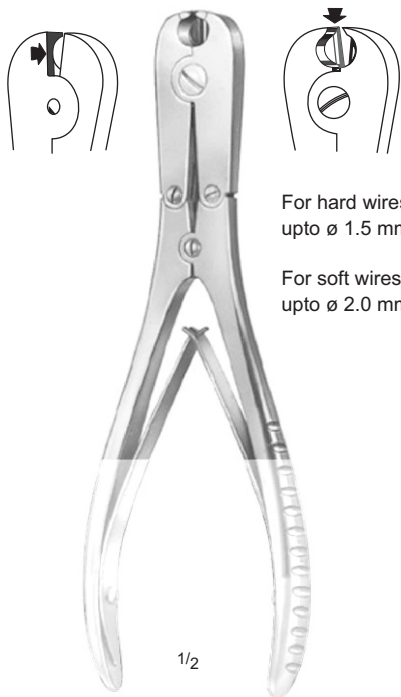

21-094-18
 18 cm / 7"

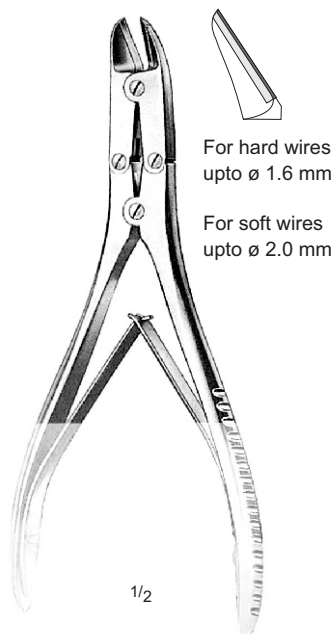

21-096-17
 17 cm / 6 3/4"

Wire Cutting Pliers, with Tungsten Carbide, T/C Inserts

Heavy
Pattern
Lateral
Cutting



T/C
21-095-24
24 cm / 9 1/2"
Wire Cutting Pliers

For Hard Wires
upto \varnothing 2.5 mm



T/C
21-098-22
22 cm / 8 3/4"
Wire Cutting Pliers



MEGA CUT ©
21-100-47
47 cm / 17 3/4"
For cutting off
Kirschner wires,
Tibia head screws
bolts, pins upto
6.0 mm \varnothing

Front
Cutting
Double
Action



T/C
21-091-15
15 cm / 6"
21-093-23
23 cm / 9"

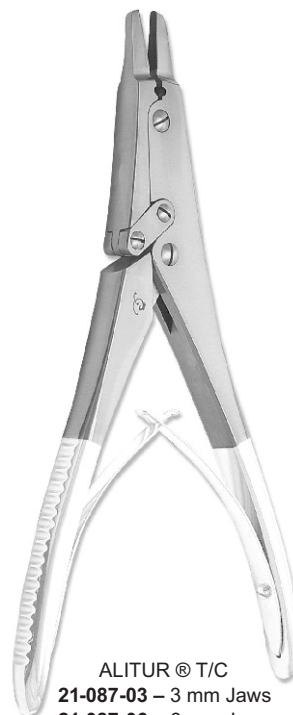

ALITUR © T/C
21-087-03 – 3 mm Jaws
21-087-06 – 6 mm Jaws
18 cm / 7"

21-100-56
56 cm / 22 1/2"
T/C
For hard wires
upto \varnothing 2.5 mm

Bone Chisels

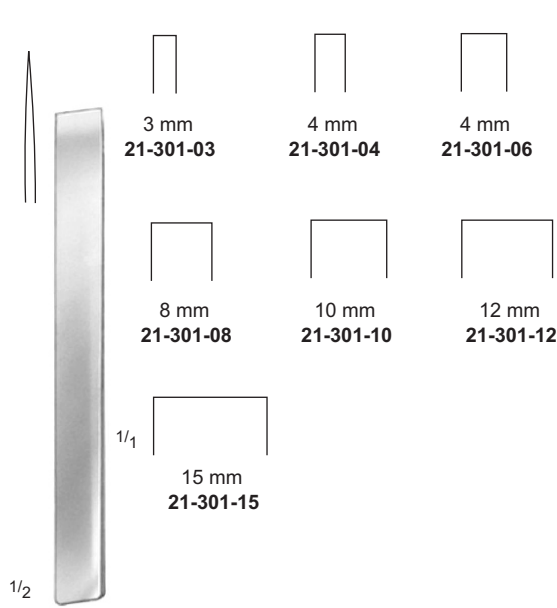

MINI LAMBOTTE
21-301-03 – 21-301-15
12.5 cm / 5"

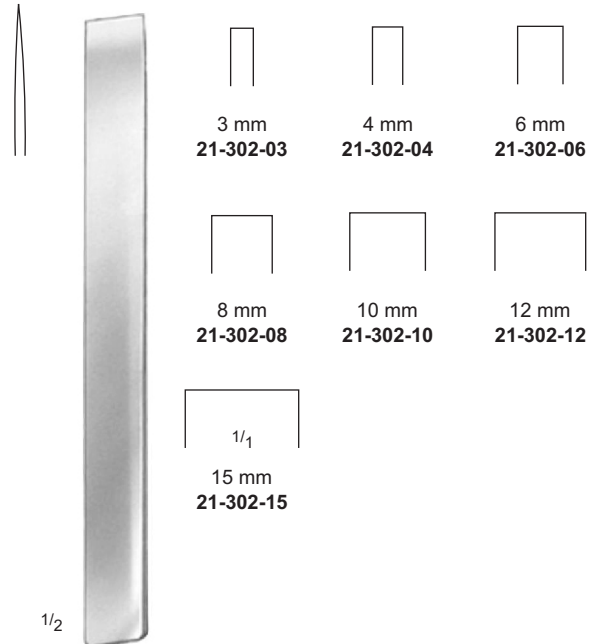

MINI LAMBOTTE
21-302-03 – 21-302-15
17 cm / 6 3/4"

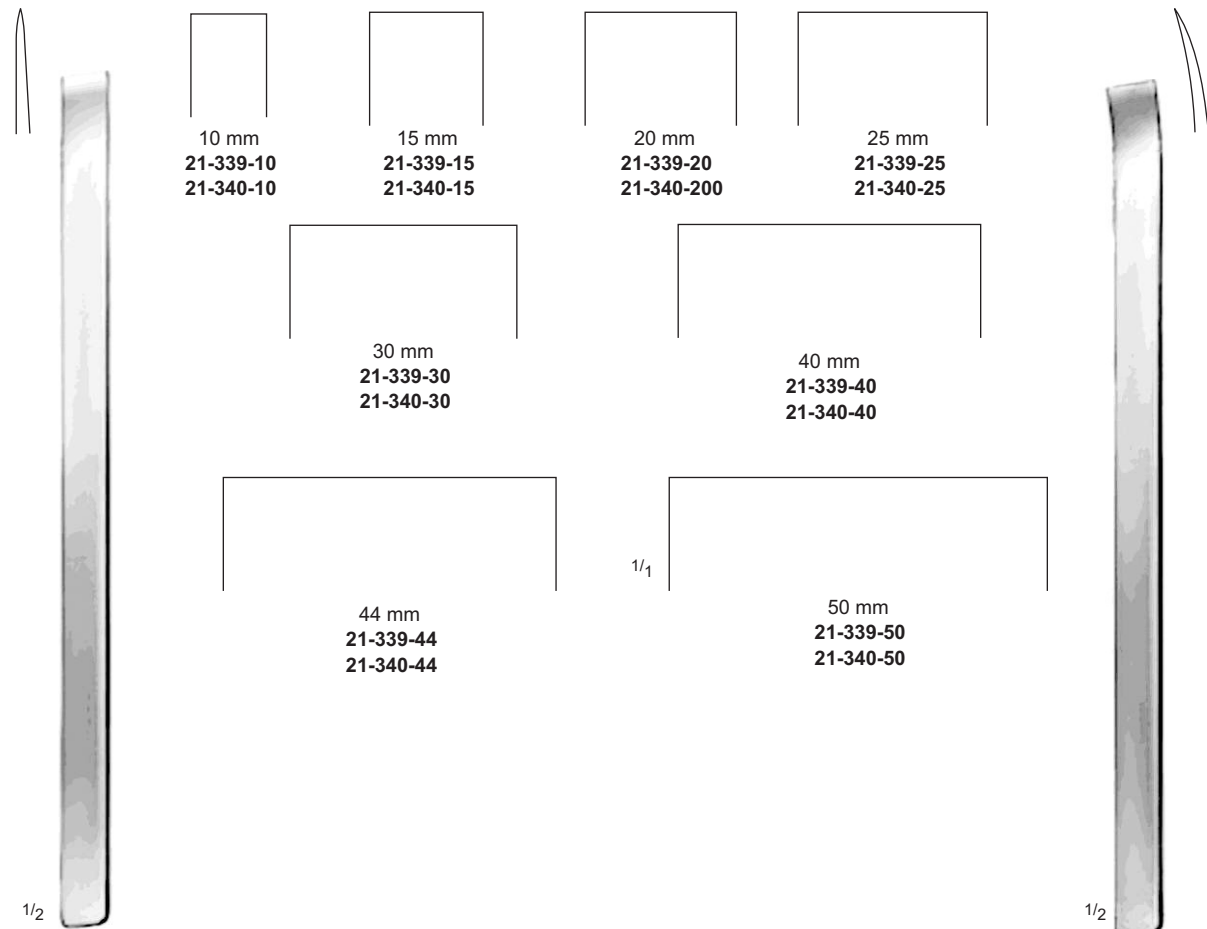

LAMBOTTE
21-339-10 – 21-339-50
24 cm / 9 1/2"

LAMBOTTE
21-340-10 – 21-34039-50
24 cm / 9 1/2"

Bone Chisels and Gouges

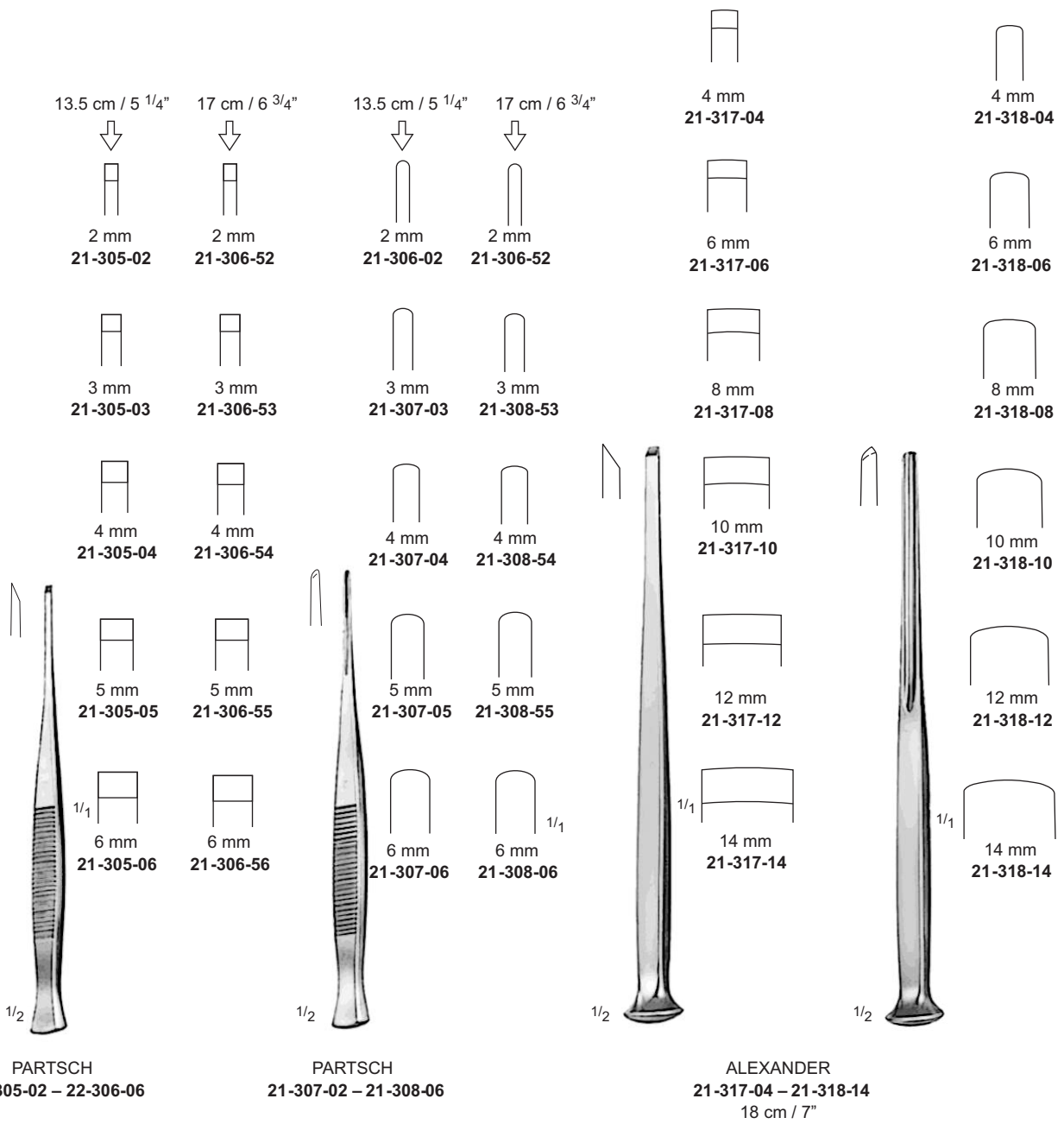

Bone Chisels and Gouges



10 mm
 21-311-10



10 mm
 21-312-10



10 mm
 21-316-10

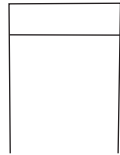

15 mm
 21-311-15

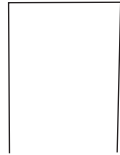

15 mm
 21-312-15

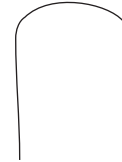

15 mm
 21-316-15

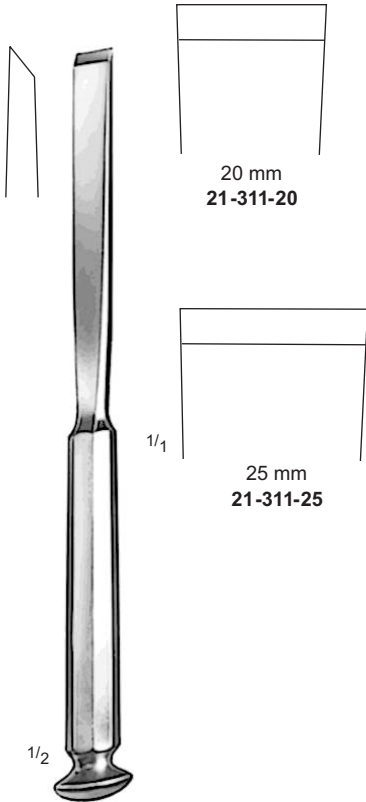

20 mm
 21-311-20

25 mm
 21-311-25

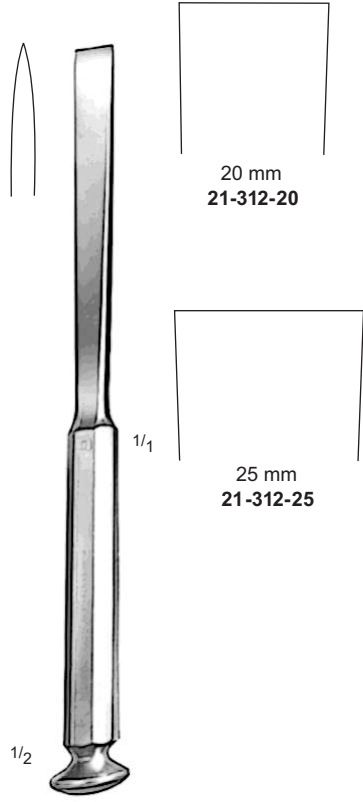

20 mm
 21-312-20

25 mm
 21-312-25

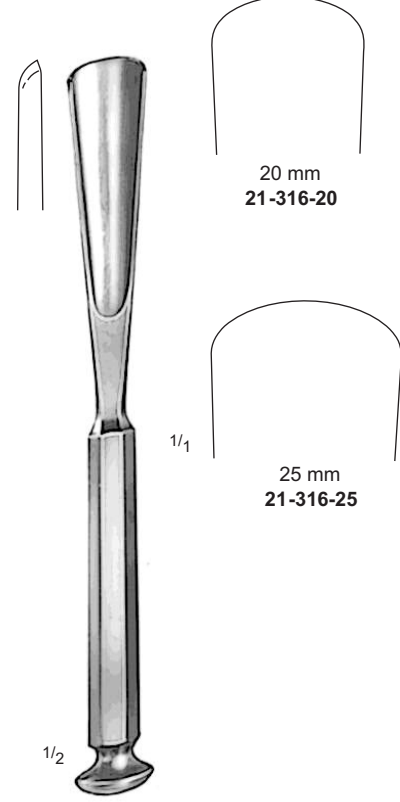

20 mm
 21-316-20

25 mm
 21-316-25

STILLE
 21-311-10 – 21-311-25
 20 cm / 8"

STILLE
 21-312-10 – 21-312-25
 20 cm / 8"

STILLE
 21-316-10 – 21-316-25
 20 cm / 8"

Bone Chisels and Gouges



8 mm
 21-323-08



10 mm
 21-323-10



12 mm
 21-323-12

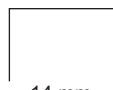

14 mm
 21-323-14



16 mm
 21-323-16



1/2

1/4

21-323-08 – 21-323-16
 13.5 cm / 5 1/4"



8 mm
 21-324-08



10 mm
 21-324-10



12 mm
 21-324-12

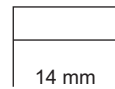

14 mm
 21-324-14

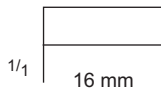

16 mm
 21-324-16



1/2

1/4

21-324-08 – 21-324-16
 13.5 cm / 5 1/4"



8 mm
 21-325-08



10 mm
 21-325-10



12 mm
 21-325-12



14 mm
 21-325-14



16 mm
 21-325-16



1/2

1/4

21-325-08 – 21-325-16
 13.5 cm / 5 1/4"

Bone Chisels and Gouges

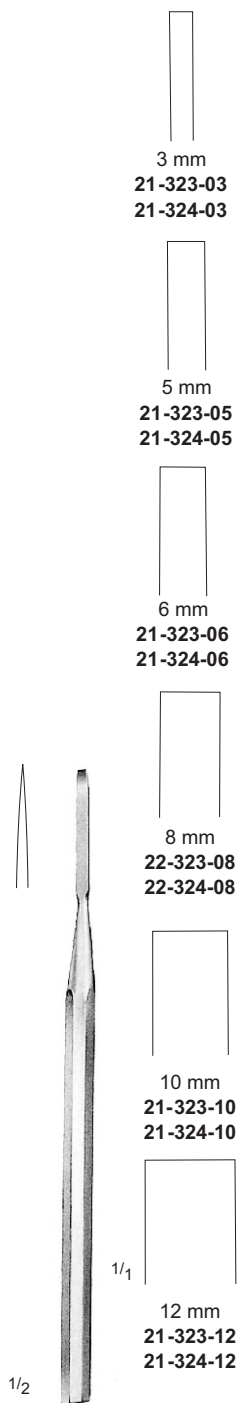

HOKE
21-323-03 – 21-32-12
14 cm / 5 1/2"

21-324-03 – 21-324-12
17 cm / 6 3/4"



6 mm
21-330-06



13 mm
21-330-13



19 mm
21-330-19

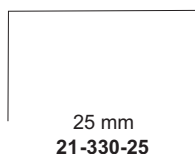

25 mm
21-330-25

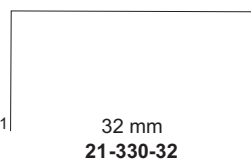

1/1
32 mm
21-330-32



1/2
HIBBS
21-330-06 – 21-330-32
24 cm / 9 1/2"

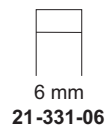

6 mm
21-331-06



13 mm
21-331-13

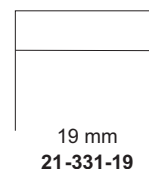

19 mm
21-331-19

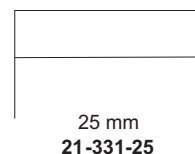

25 mm
21-331-25

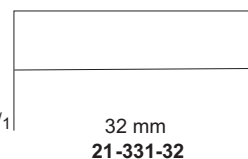

1/1
32 mm
21-331-32



1/2
HIBBS
21-331-06 – 21-331-32
24 cm / 9 1/2"

Bone Chisels and Gouges

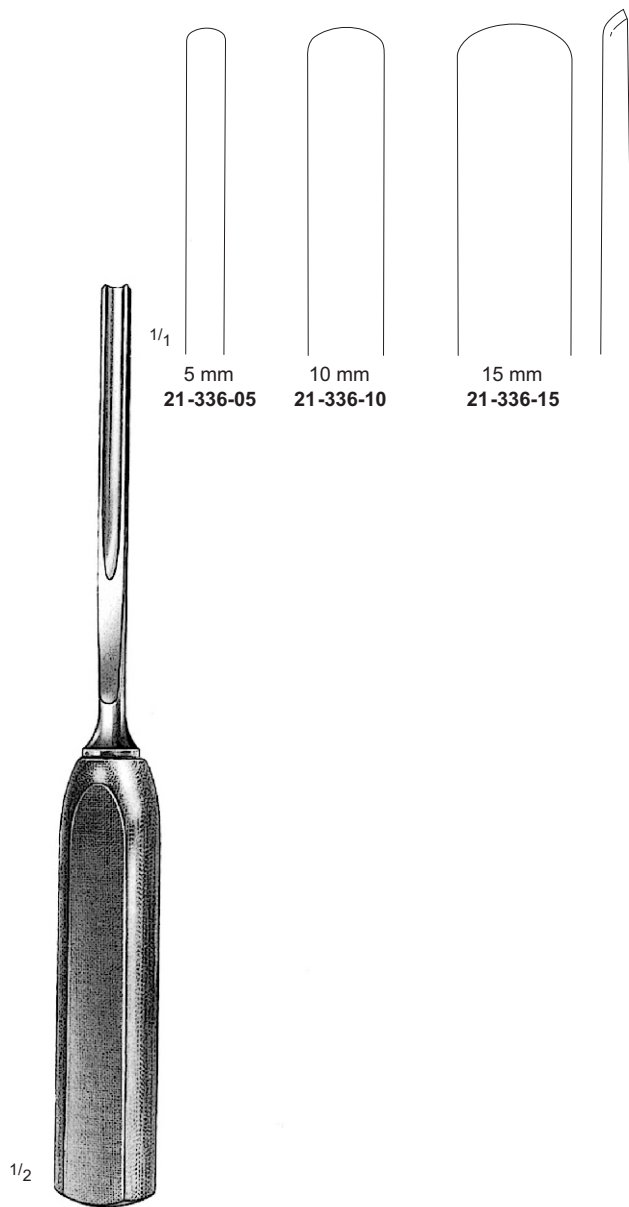

5 mm
21-336-05

10 mm
21-336-10

15 mm
21-336-15

LEXER
 21-336-05 – 21-336-15
 25 cm / 10"
 Handle from artificial wood

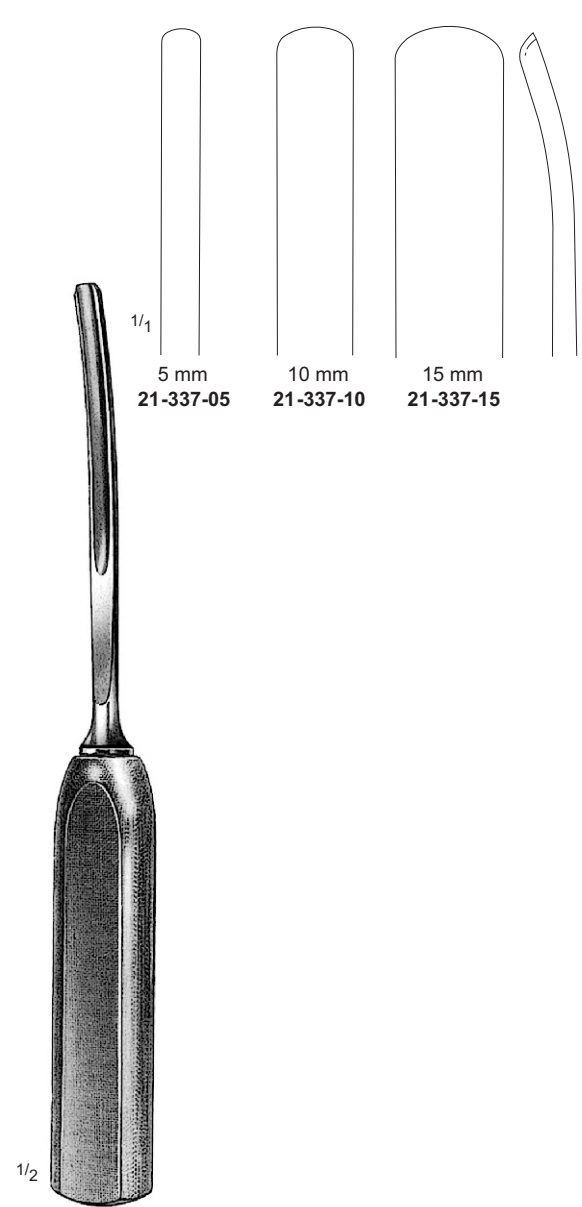

5 mm
21-337-05

10 mm
21-337-10

15 mm
21-337-15

LEXER
 21-333-05 – 21-337-15
 25 cm / 10"
 Handle from artificial wood

Bone Chisels and Gouges

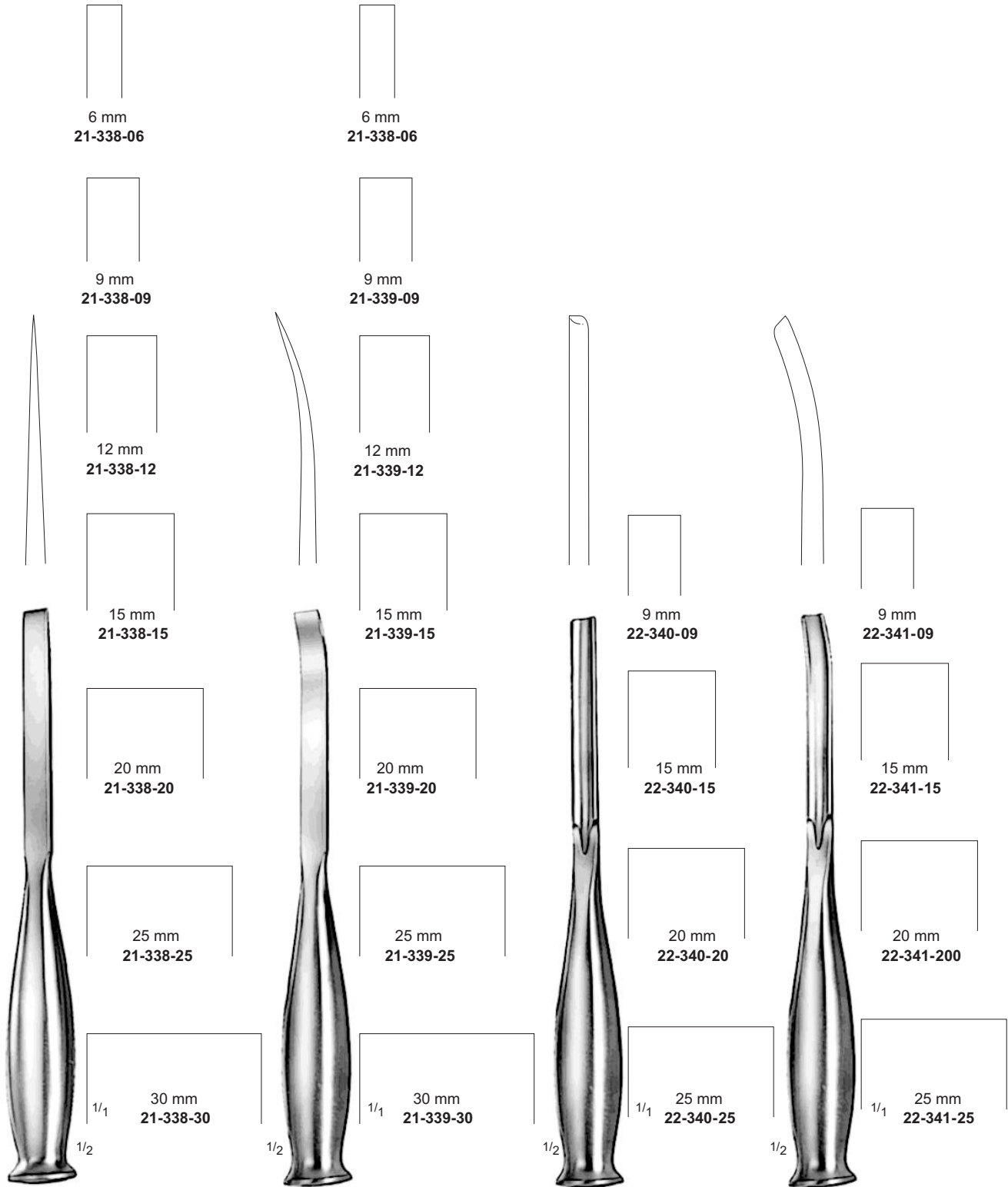

SMITH - PETERSON
 21-338-06 – 21-341-25
 20 cm / 8"

Bone Chisels and Gouges, Meniscotome Knives

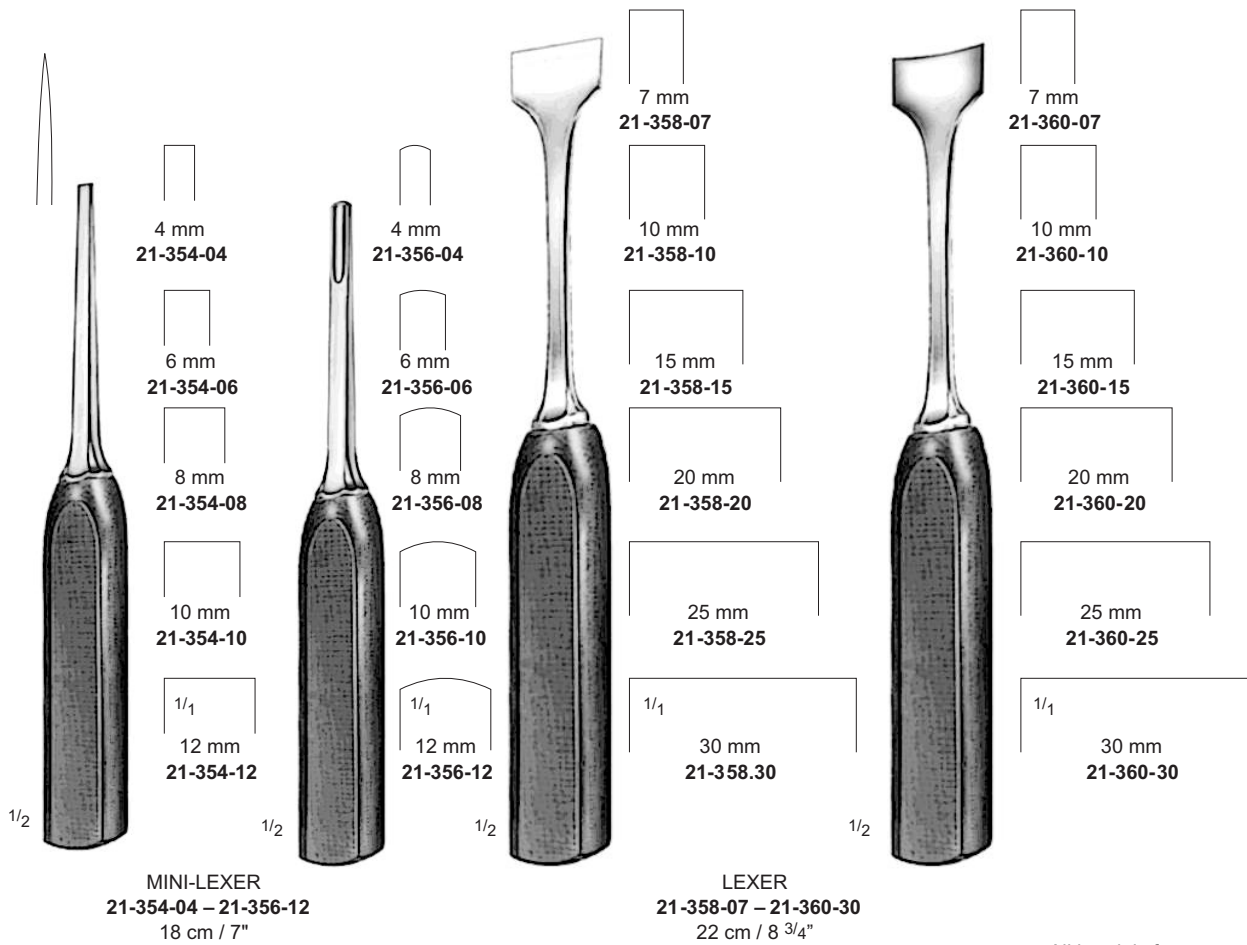

All handles from artificial wood

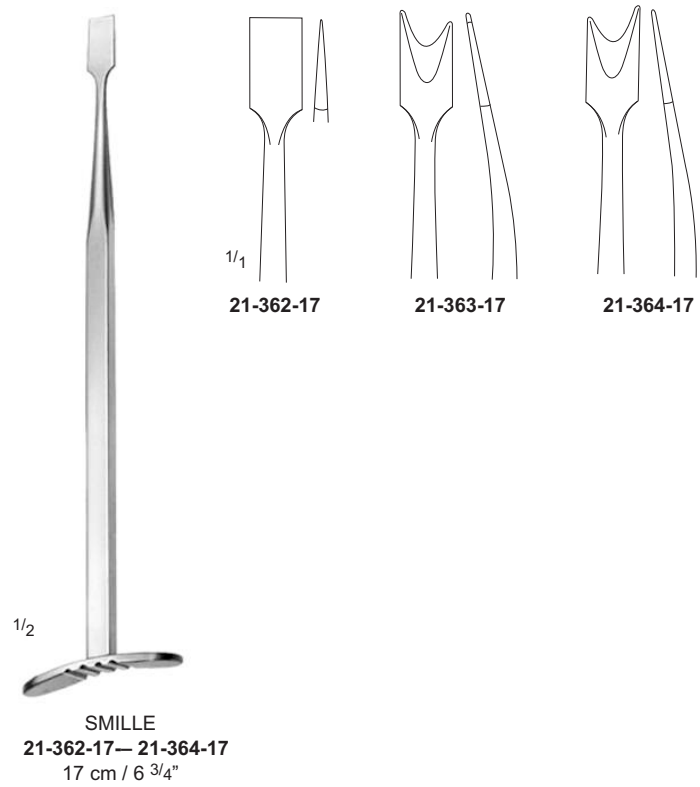

Bone Curettes

○ 3 mm

31-369-40
Fig. # 0000

○ 4 mm

31-369-30
Fig. # 000

○ 4.5 mm

31-369-20
Fig. # 00

○ 5.5 mm

31-369-00
Fig. # 0

○ 6 mm

31-369-01
Fig. # 1

○ 7.5 mm

31-369-02
Fig. # 2

○ 8.5 mm

31-369-03
Fig. # 3

○ 10 mm

31-369-04
Fig. # 4

$\frac{1}{4}$ ○ 11.5 mm

31-369-05
Fig. # 5

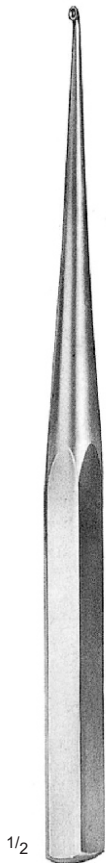

BRUNS
31-369-24 – 31-369-55
23 cm / 9"

○

21-370-64
Fig. # 0000

○

21-370-92
Fig. # 2

○

21-370-50
Fig. # 0

○

21-370-73
Fig. # 000

○

21-370-93
Fig. # 3

○

21-370-51
Fig. # 1

○

21-370-82
Fig. # 00

○

21-370-94
Fig. # 4

○

21-370-52
Fig. # 2

○

21-370-90
Fig. # 0

○

21-370-95
Fig. # 5

○

21-370-53
Fig. # 3

$\frac{1}{4}$ ○

21-370-91
Fig. # 1

○

21-370-96
Fig. # 6

$\frac{1}{4}$ ○

21-370-54
Fig. # 4

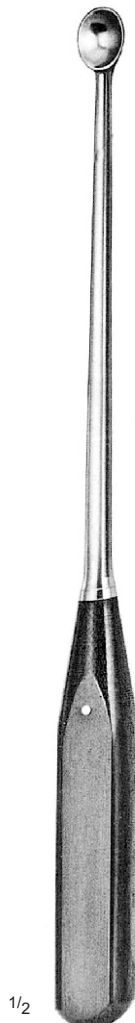

BRUNS
21-370-64 – 21-370-96
27 cm / 10 $\frac{3}{4}$ "









All handels from
artificial wood



BRUNS
21-370-50 – 21-370-54
17 cm / 6 $\frac{3}{4}$ "





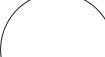



Bone Currettes



2mm  Fig. # 0000 21-371-40	3mm  Fig. # 000 21-371-30	4mm  Fig. # 00 21-371-20
5mm  Fig. # 0 21-371-10	6mm  Fig. # 1 21-371-01	8mm  Fig. # 2 21-371-02
10mm  Fig. # 3 21-371-03	12mm  Fig. # 4 21-371-04	13mm  Fig. # 5 21-371-05
14mm  Fig. # 6 21-371-06		











BRUNS
21-371-40 – 32-371-06
17 cm / 6 3/4"



2mm  21-372-40 Fig. # 0000	3mm  21-372-30 Fig. # 000	4mm  21-372-20 Fig. # 00
4.5mm  21-372-10 Fig. # 0	5mm  21-372-01 Fig. # 1	6mm  21-372-02 Fig. # 2
7mm  21-372-03 Fig. # 3	8mm  21-372-04 Fig. # 4	9mm  21-372-05 Fig. # 5



SPRATT
21-372-40 – 21-372-05
17 cm / 6 3/4"



3mm  21-374-40 Fig. # 0000	3.7mm  21-374-30 Fig. # 000	4.5mm  21-374-20 Fig. # 00
5.2mm  21-374-10 Fig. # 0	6.8mm  21-374-01 Fig. # 1	8.5mm  21-374-02 Fig. # 2
10mm  21-374-03 Fig. # 3	11.5mm  21-374-04 Fig. # 4	13.0mm  21-374-05 Fig. # 5
14.5mm  21-374-06 Fig. # 6		

VOLKMANN
21-374-40 – 21-374-06
17 cm / 6 3/4"



3 mm 
4 mm 
5 mm 

Bushe
21-376-03 — 21-376-05
25 cm / 9 7/8"

Bone Curettes

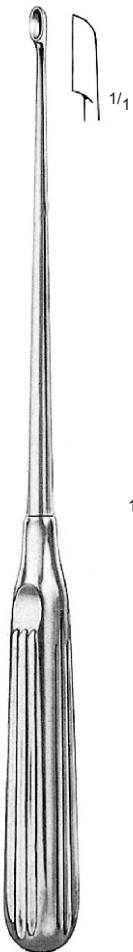

BRUNS-VOLKMANN
21-375-40 – 21-377-06
23 cm / 9"



21-375-40 – 21-376-56



21-377-40 – 21-377-06

○
21-375-40
21-376-40
21-377-40
Fig. # 0000

○
21-375-30
21-376-30
21-377-30
Fig. # 000

○
21-375-20
21-376-20
21-377-20
Fig. # 00

○
21-375-10
21-376-10
21-377-10
Fig. # 0

○
21-375-01
21-376-01
21-377-01
Fig. # 1

1/1 ○
21-375-02
21-376-02
21-377-02
Fig. # 2

○
21-375-03
21-376-03
21-377-03
Fig. # 3

○
21-375-04
21-376-04
21-377-04
Fig. # 4

○
21-375-05
21-376-05
21-377-05
Fig. # 5

○
21-375-06
21-376-06
21-377-06
Fig. # 6



VOLKMANN
21-378-13 - 21-378-17



21-378-13
13 cm / 5"



21-378-14
14 cm / 5 1/2"



21-378-17
17 cm / 6 3/4"



WILLIGER
21-379-10 – 21-379-12
13.5 cm / 5 1/4"

21-379-10

21-379-11

21-379-11

21-379-12

21-379-12

21-379-12



21-380-01
Fig # 1



21-380-02
Fig # 2



21-380-03
Fig # 3



VOLKMANN
21-380-01 – 21-380-03
22 cm / 8 3/4"

Bone Rongeurs

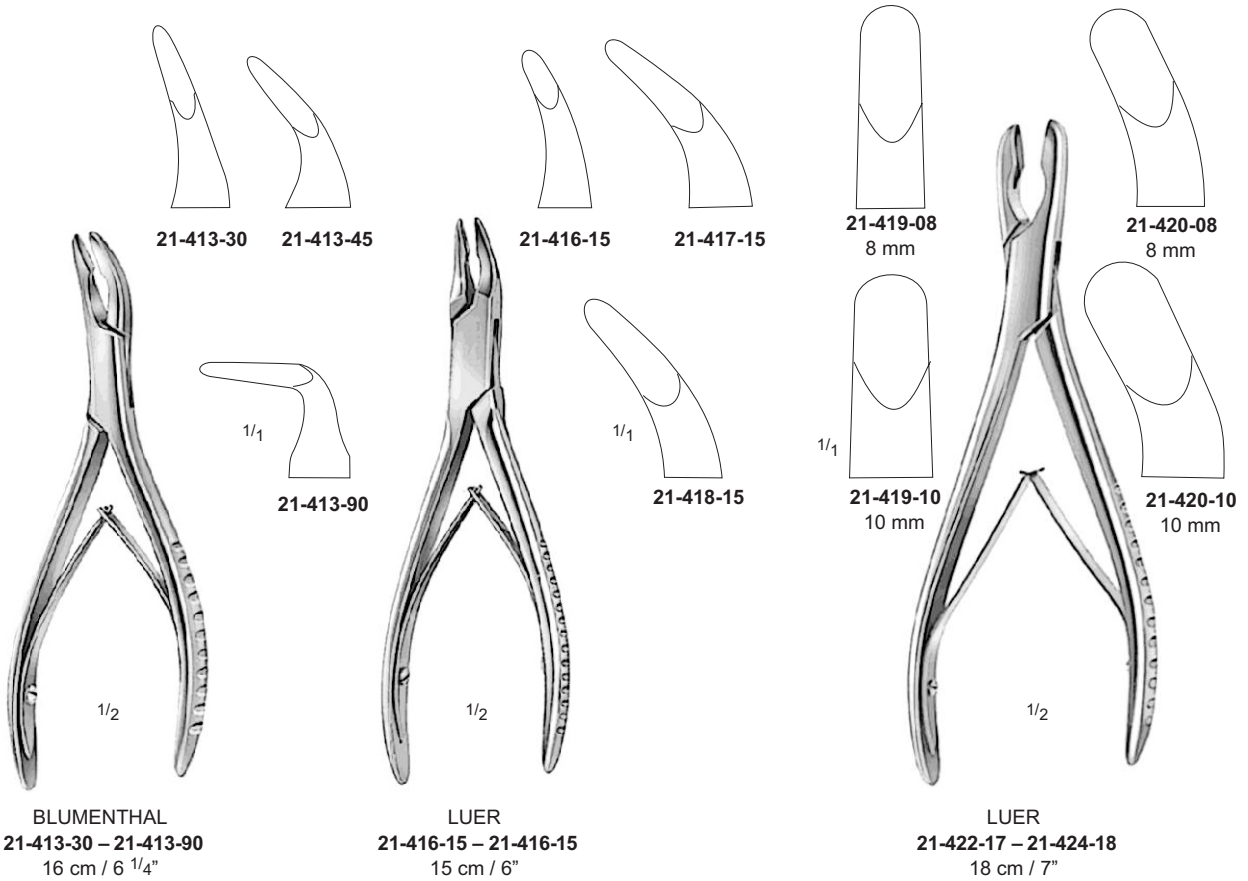
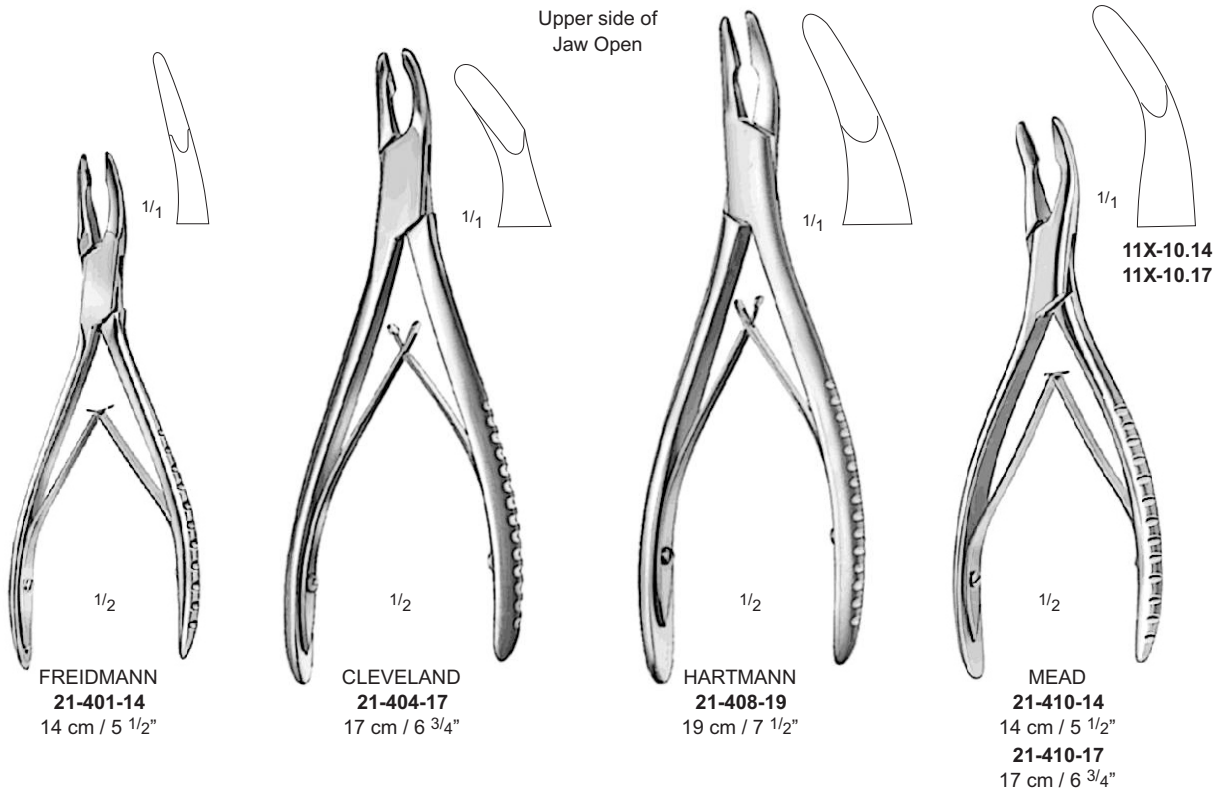

Bone Rongeurs

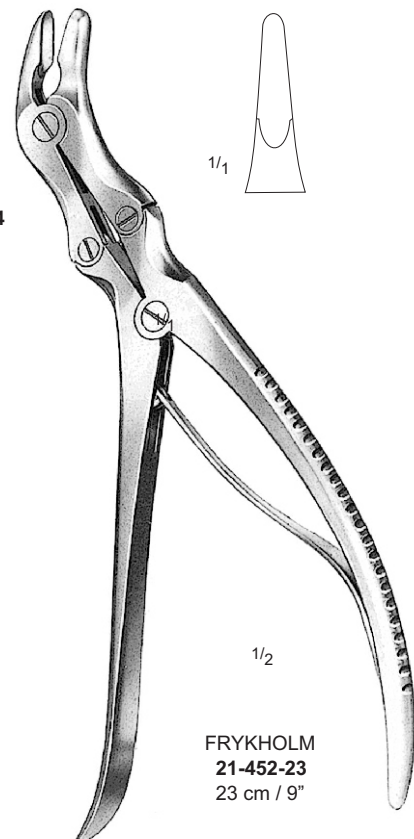
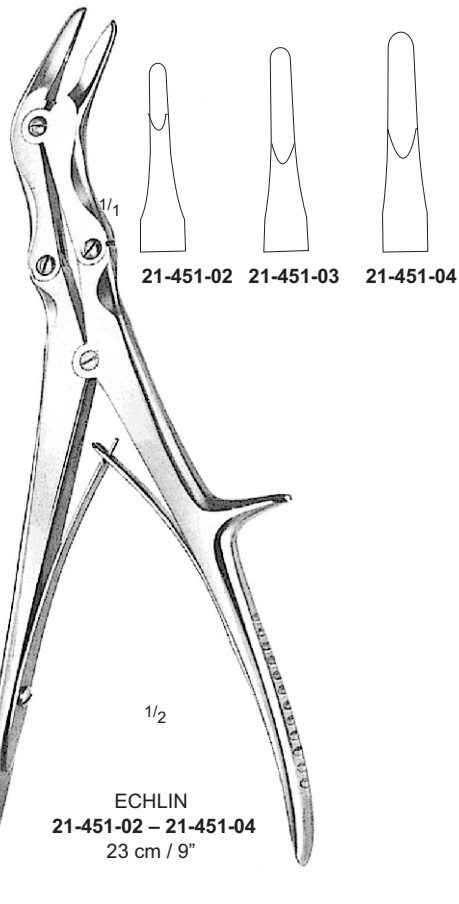
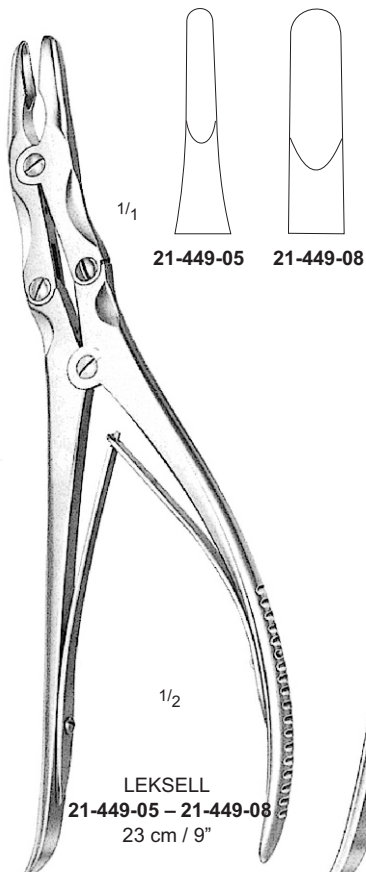
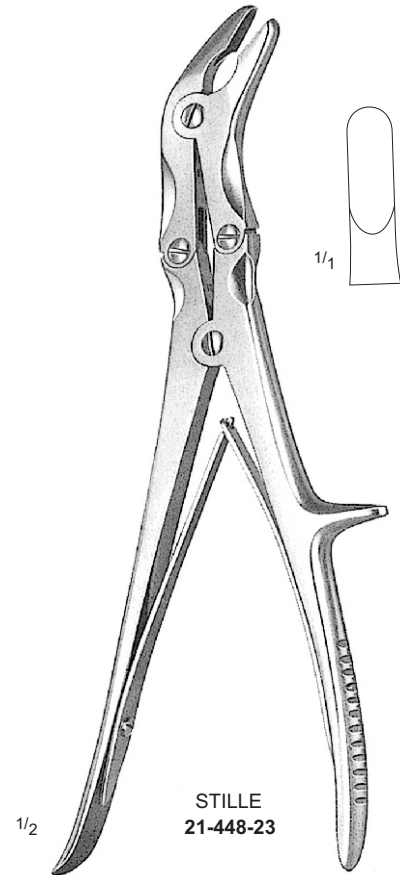
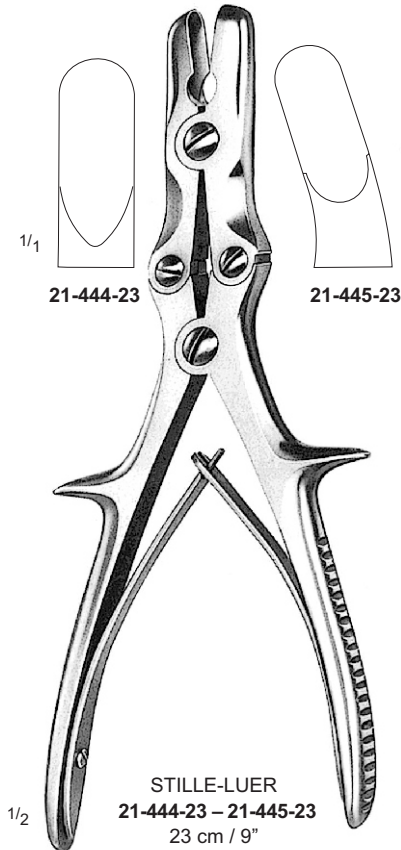
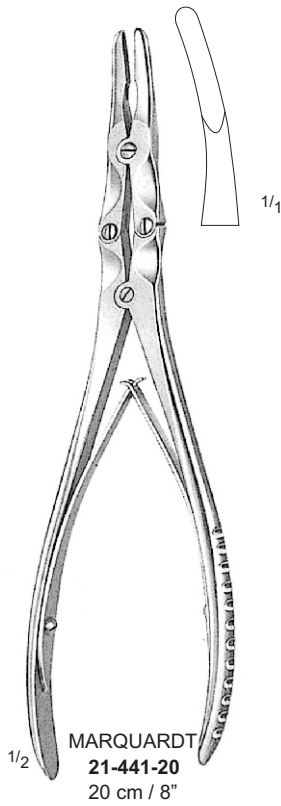

Bone Rongeurs

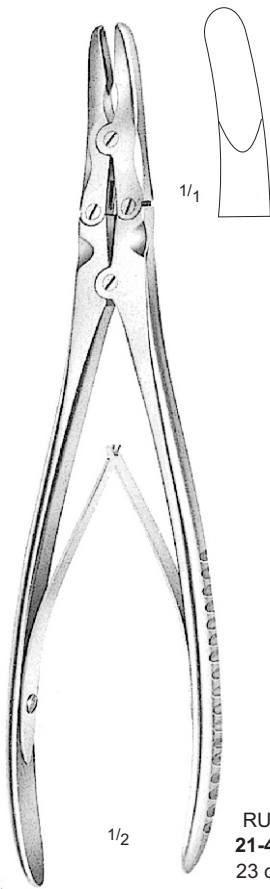

RUSKIN
 21-426-33
 23 cm / 9"

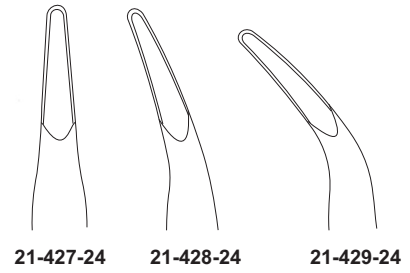
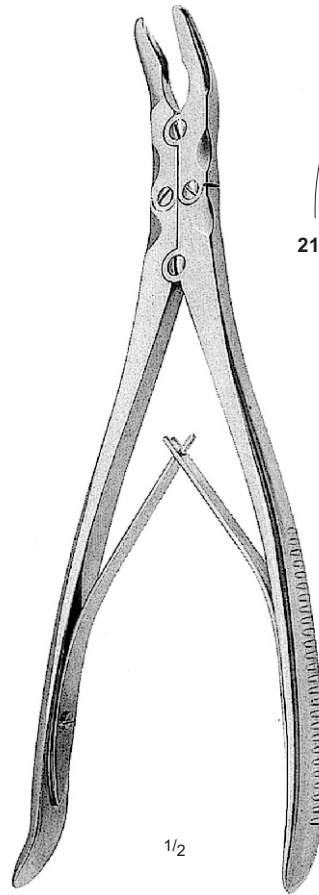

SMITH PETERSON
 21-427-24 – 21-429-24
 24 cm / 9 1/2"

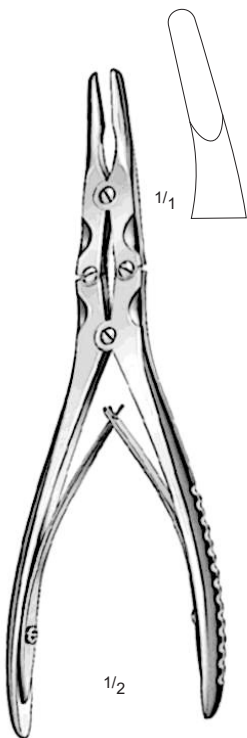

ZAUFAL-JANSEN
 21-430-18
 18 cm / 7"

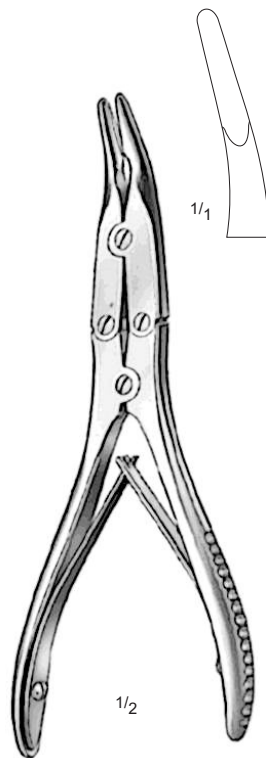

BEYER
 21-031-18
 18 cm / 7"

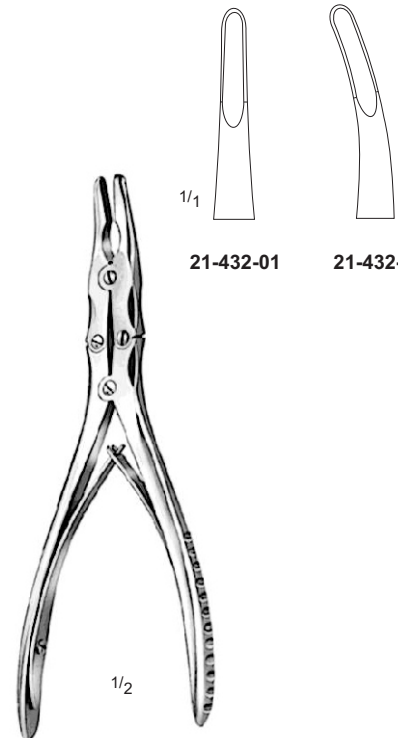

BOHLER
 21-432-01 – 121-432-02
 15 cm / 6"

Bone Rongeurs

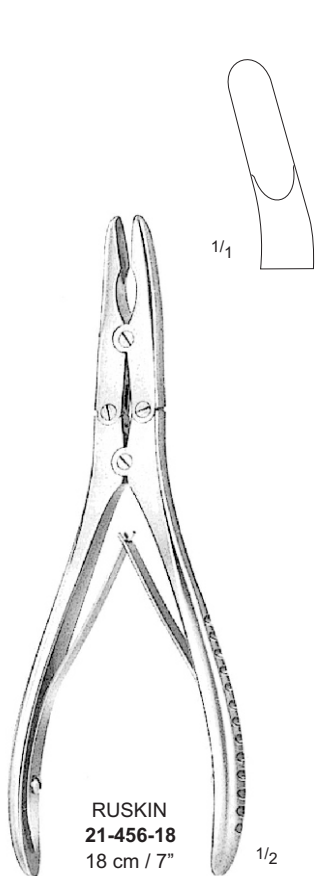

RUSKIN
21-456-18
 18 cm / 7"

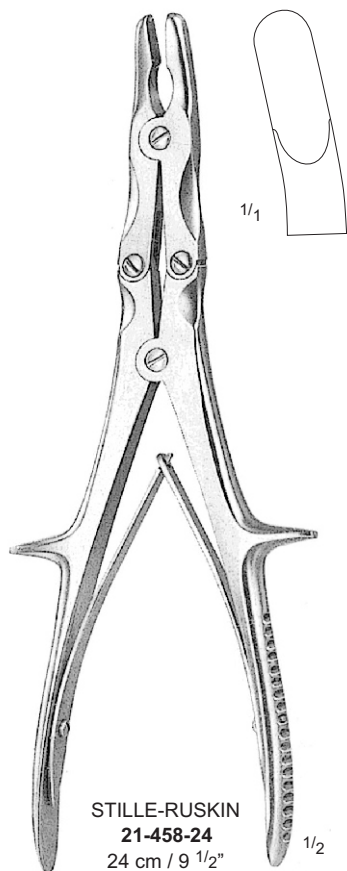

STILLE-RUSKIN
21-458-24
 24 cm / 9 1/2"

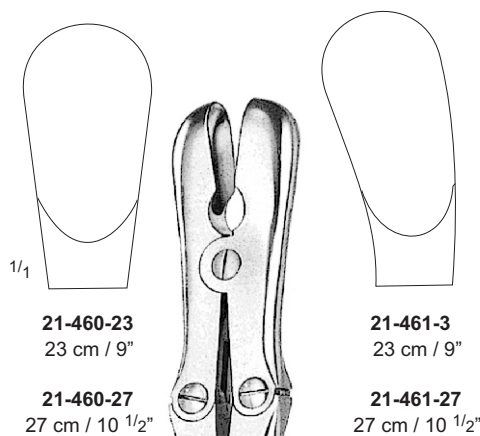

21-460-23
 23 cm / 9"

21-461-3
 23 cm / 9"

21-460-27
 27 cm / 10 1/2"

21-461-27
 27 cm / 10 1/2"

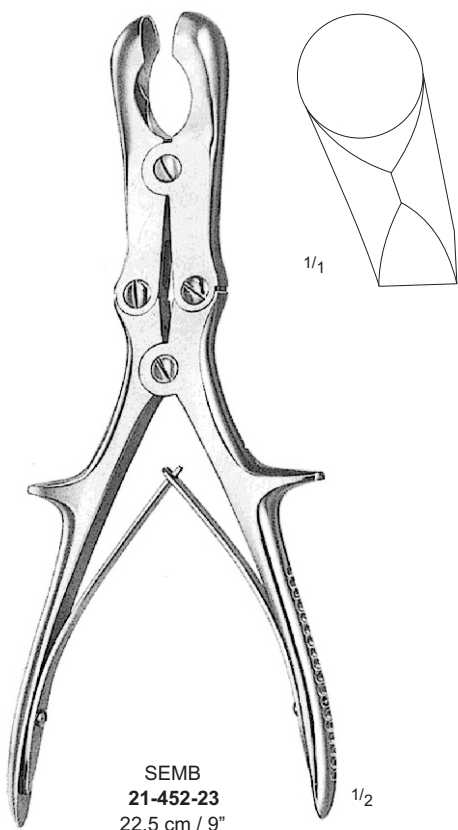

SEMB
21-452-23
 22.5 cm / 9"

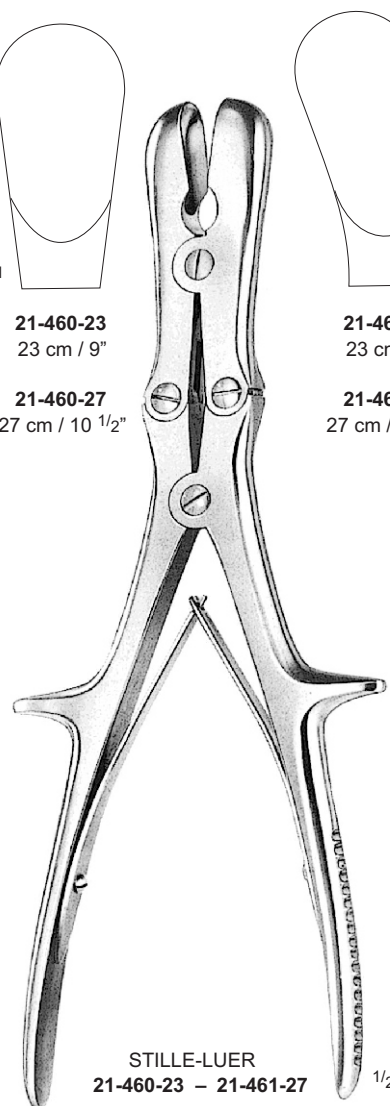

STILLE-LUER
21-460-23 - 21-461-27