

# Cardiovascular

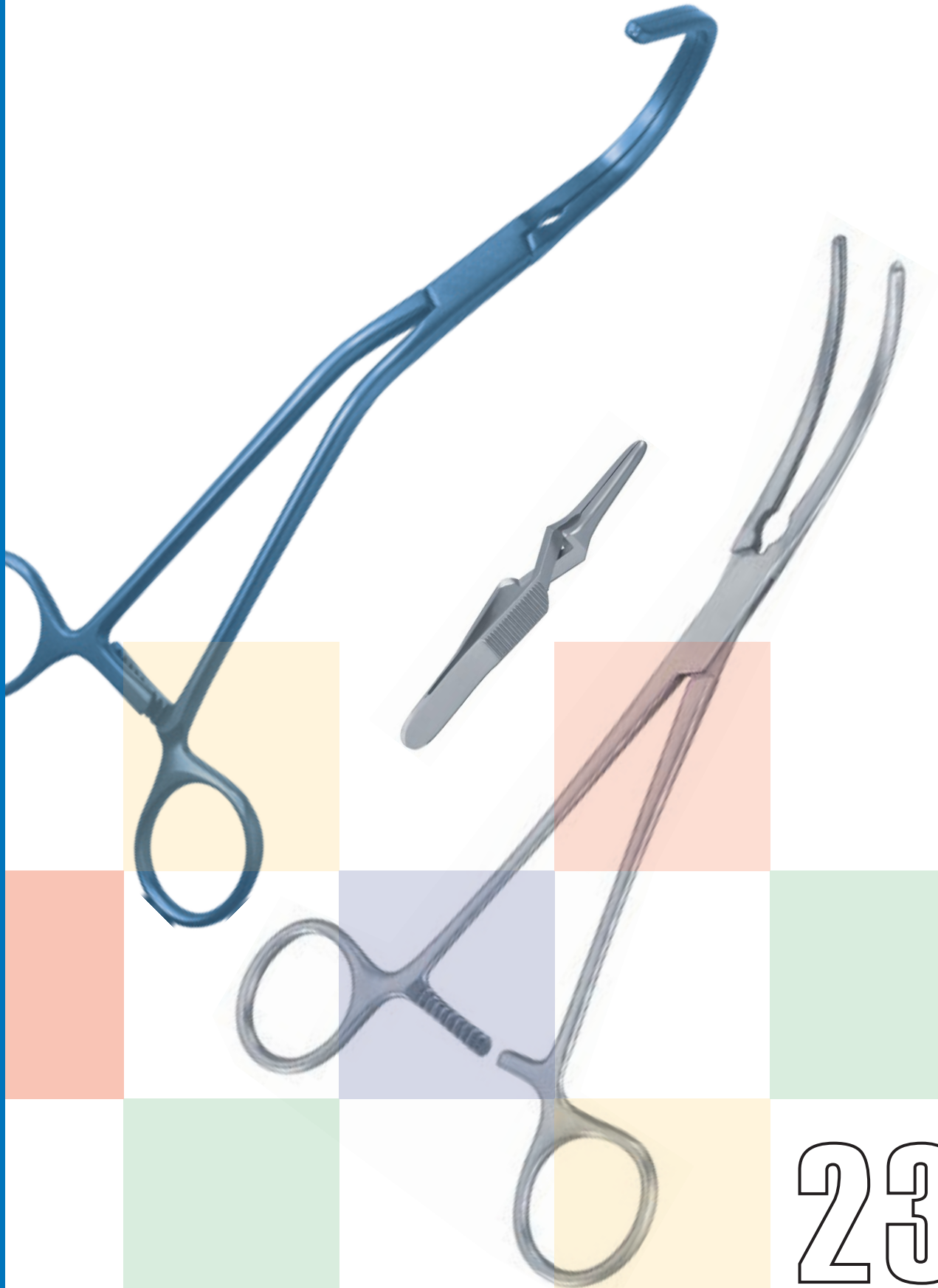

Atraumatic Bulldog Clamps

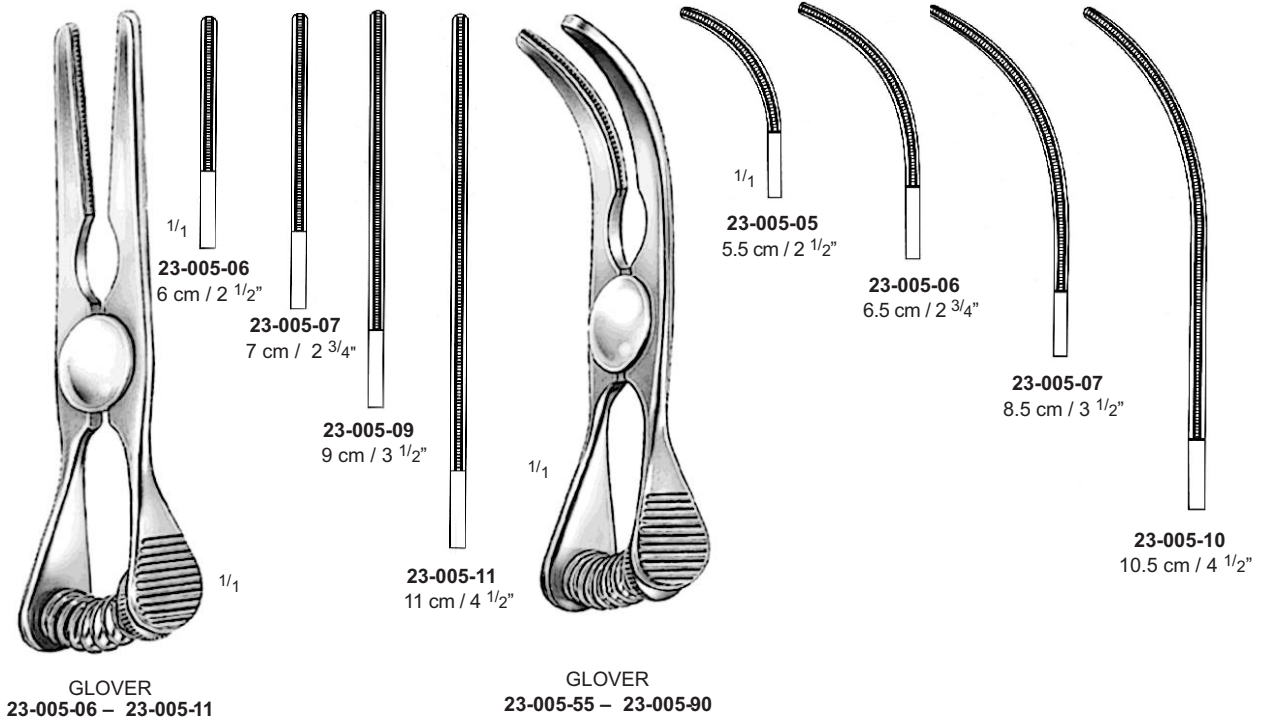
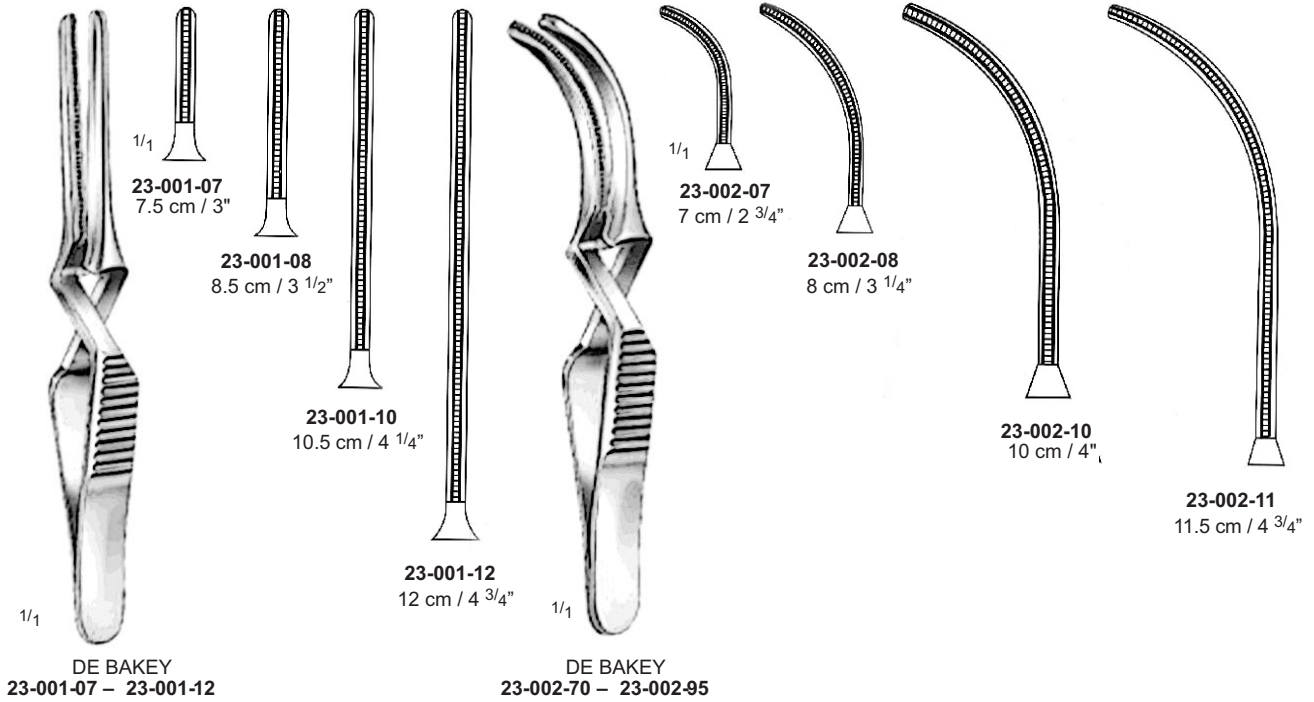

Atraumatic Cardiovascular Forceps

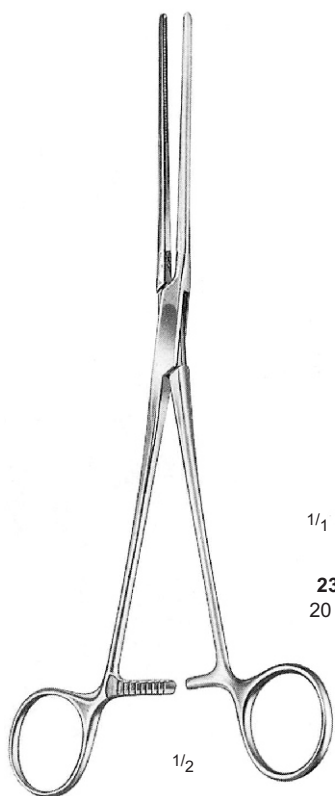

POTTS  
 23-006-21 – 23-006-22



23-006-21  
 20 cm / 8"

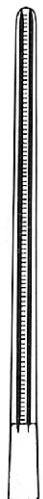

23-006-22  
 22 cm / 8 3/4"

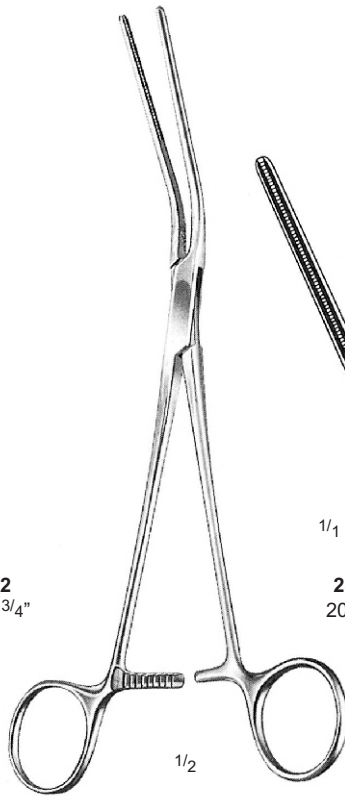

POTTS  
 23-007-20 – 23-007-22



23-007-21  
 20 cm / 8"

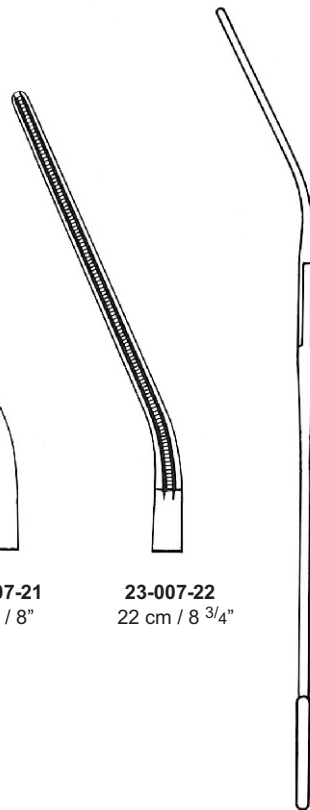

23-007-22  
 22 cm / 8 3/4"

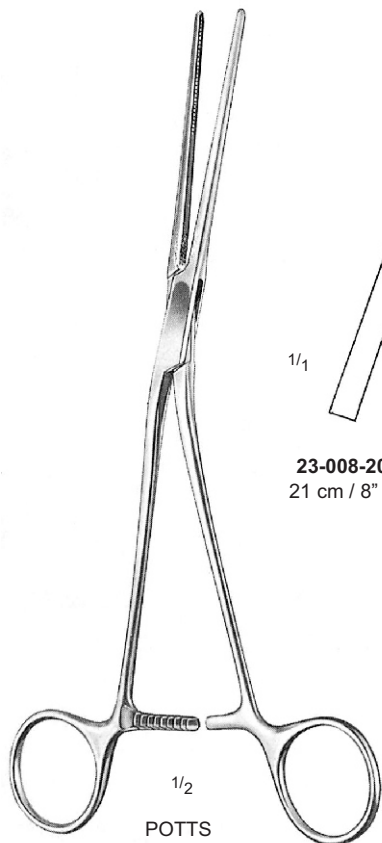

POTTS  
 23-008-20 – 23-008-22

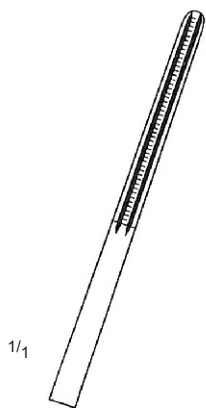

23-008-20  
 21 cm / 8"

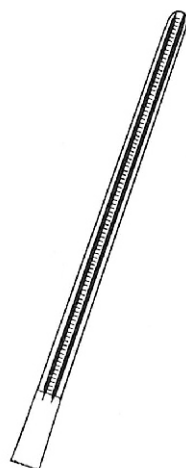

23-008-22  
 22 cm / 8"

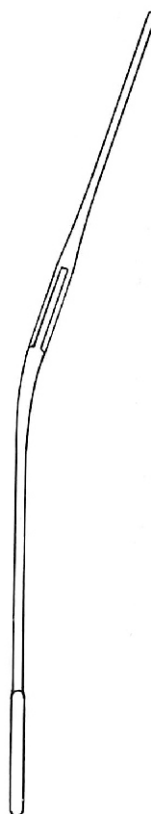

Atraumatic Cardiovascular Forceps

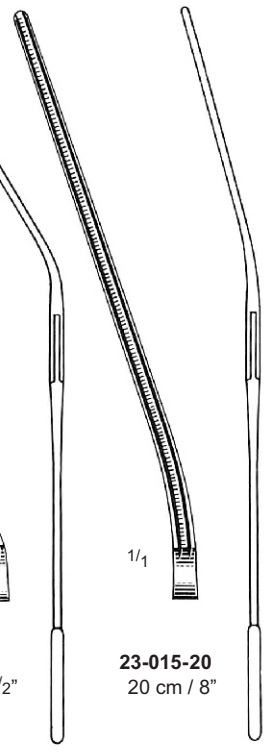
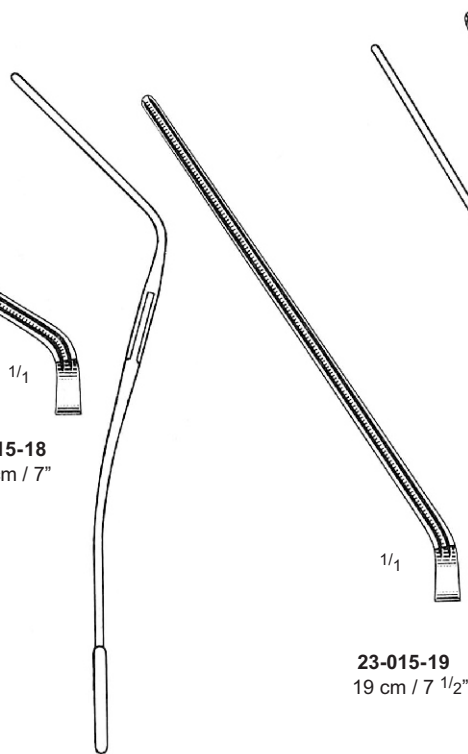
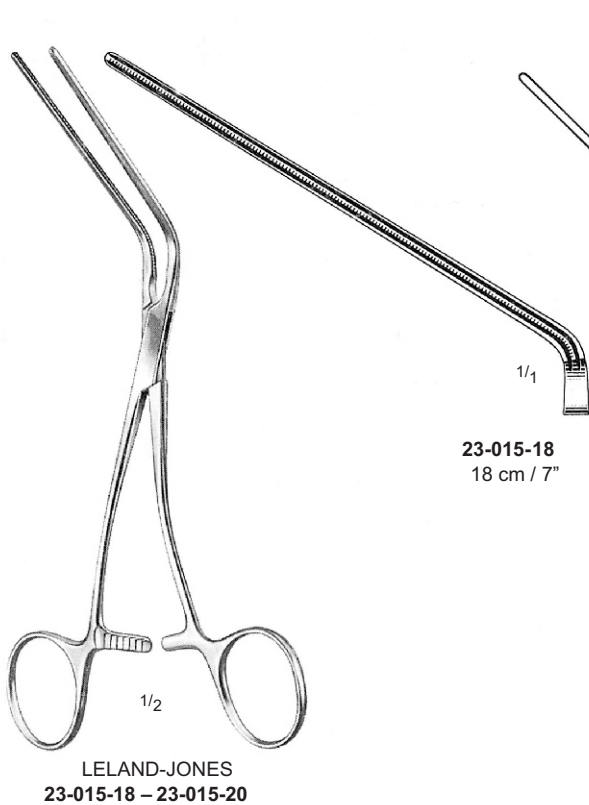
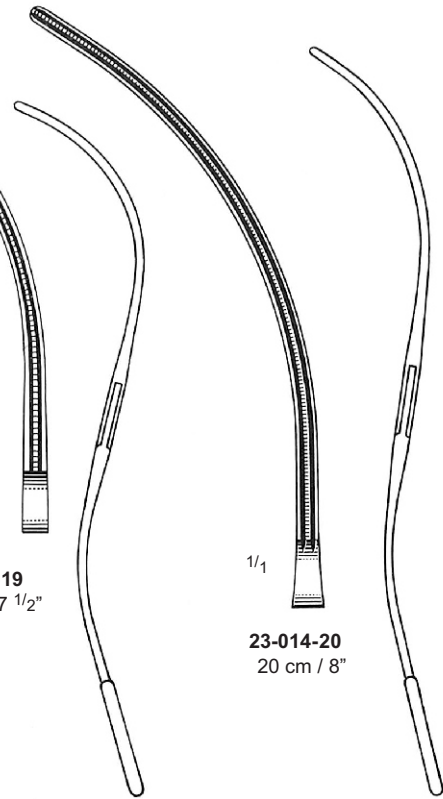
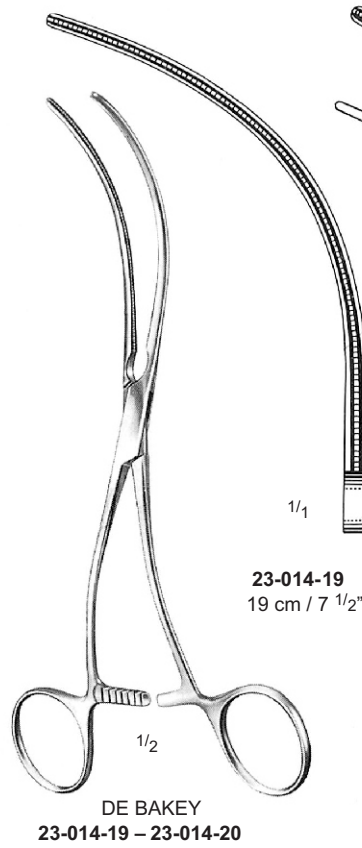
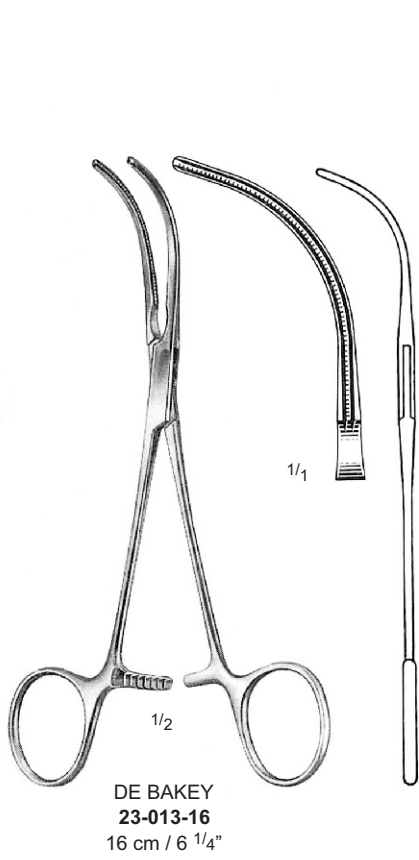

Atraumatic Cardiovascular Forceps

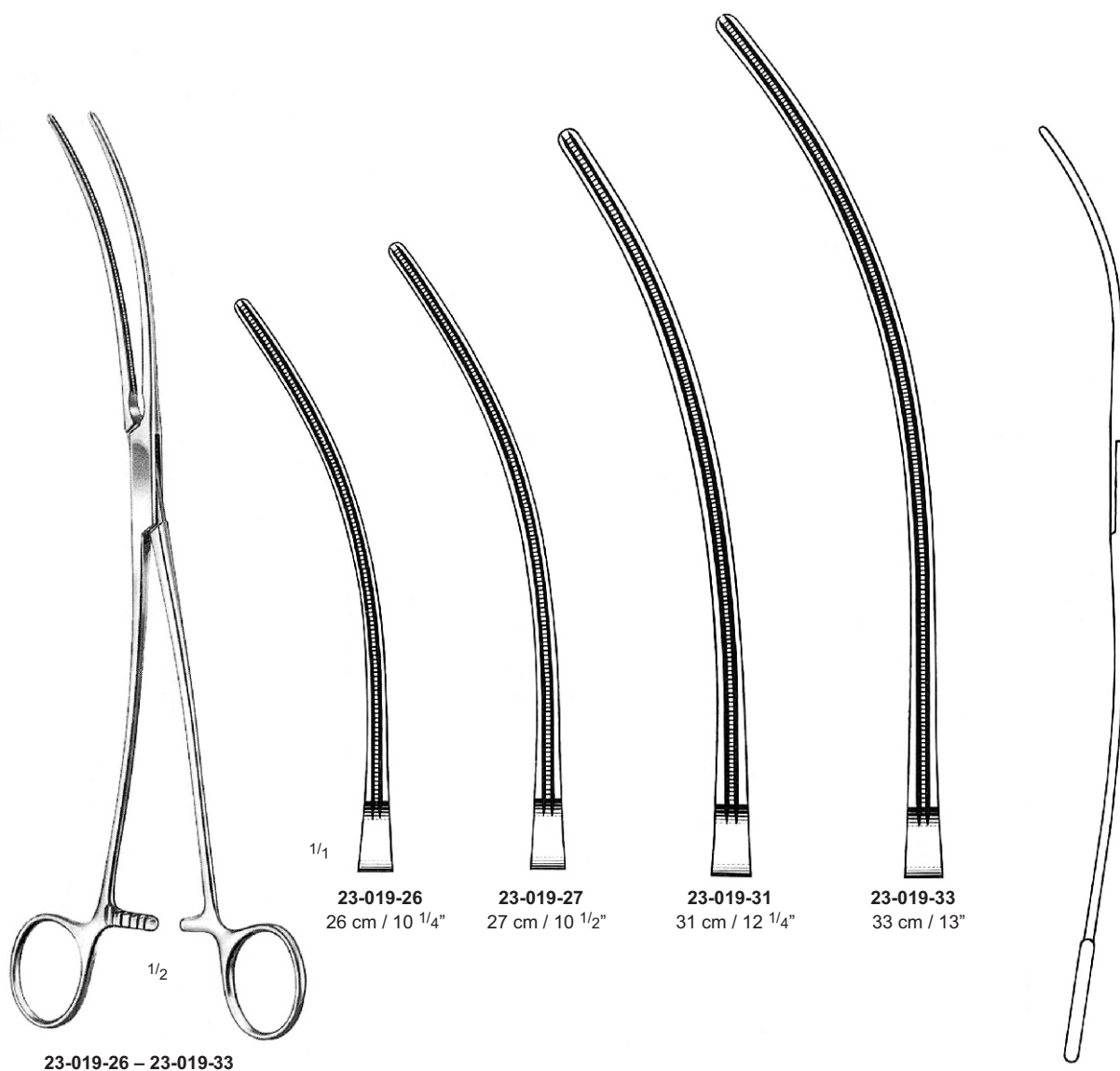

013-19.26 – 013-19.33 Aortic Aneurysm Clamps

Atraumatic Cardiovascular Forceps

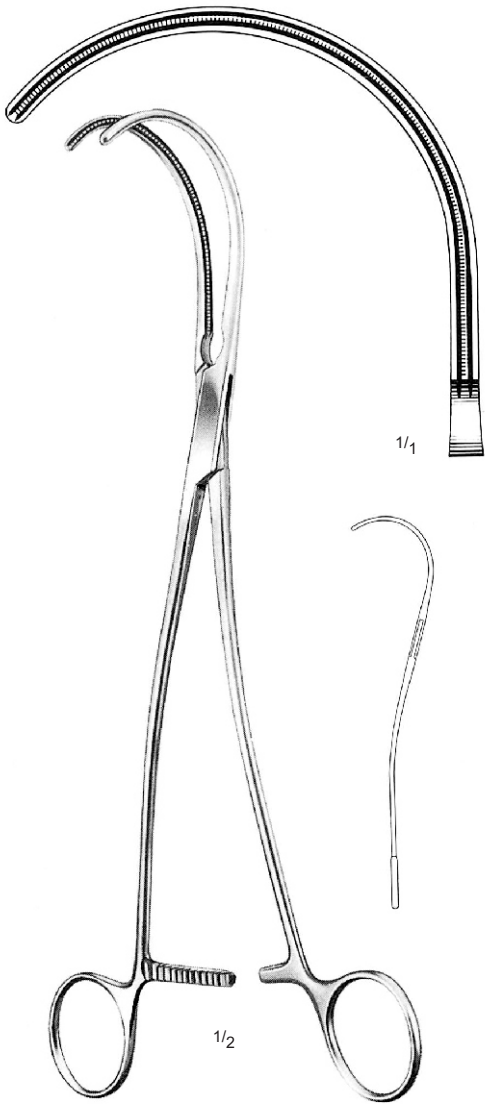

DE BAKEY  
 23-025-26  
 26 cm / 10 1/4"



SATINSKY  
 23-028-20 – 23-028-27

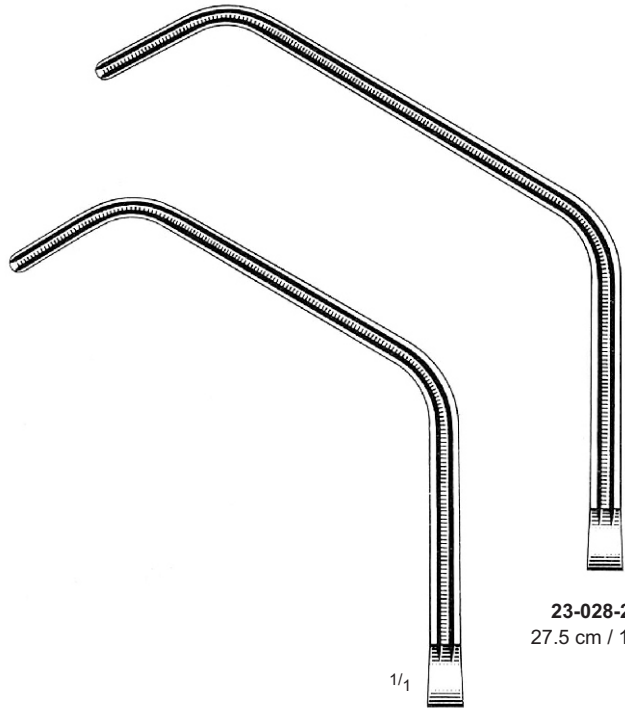

23-028-26  
 26.5 cm / 10 1/2"

23-028-27  
 27.5 cm / 10 3/4"

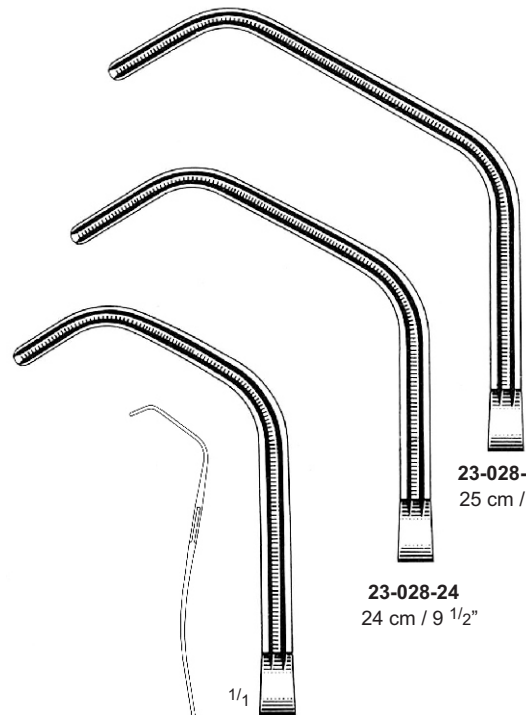

23-028-24  
 24 cm / 9 1/2"

23-028-25  
 25 cm / 10"

23-028-20  
 20.5 cm / 8 1/4"

Atraumatic Cardiovascular Forceps

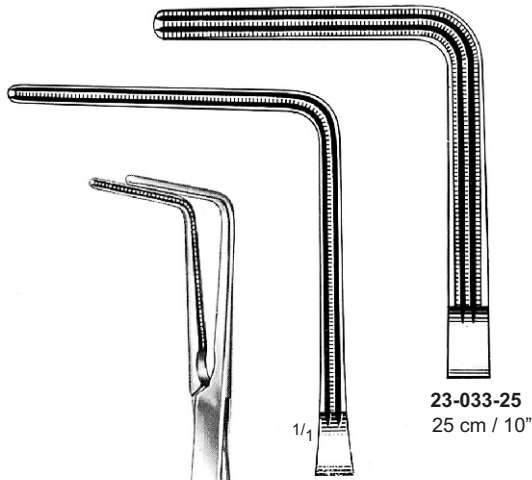

23-033-23  
 23 cm / 9"

23-033-25  
 25 cm / 10"

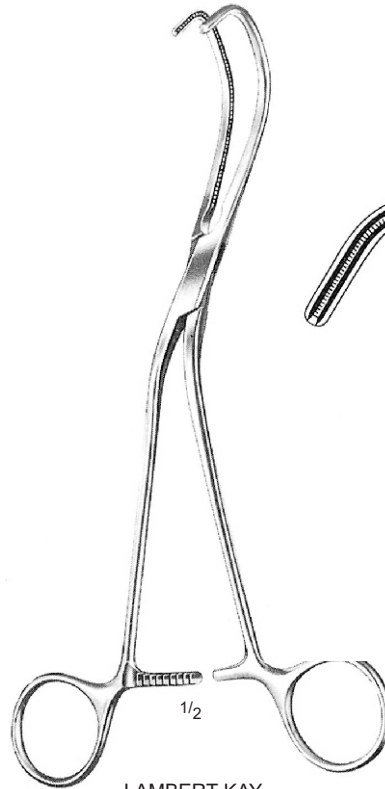

LAMBERT-KAY  
 23-035-21  
 21 cm / 8 1/4"

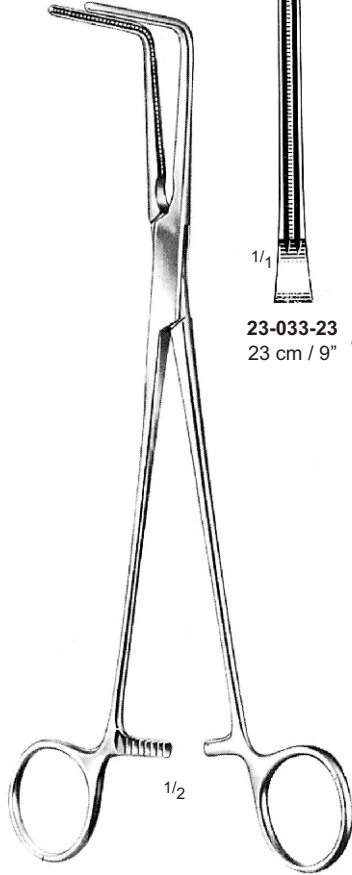

LEES  
 23-033-23 – 23-033-25

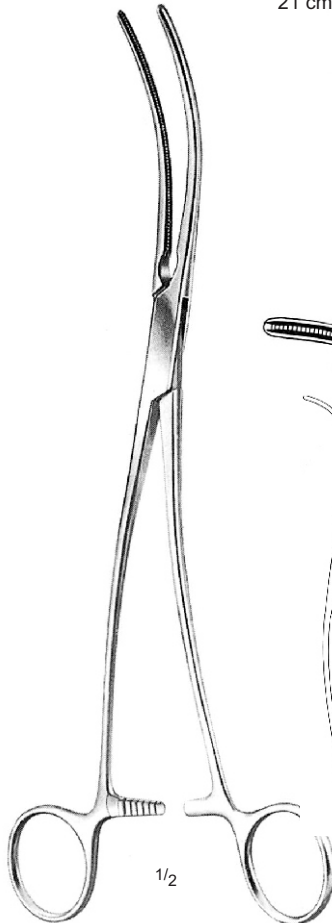

DE BAKEY  
 23-038-23 – 23-038-25

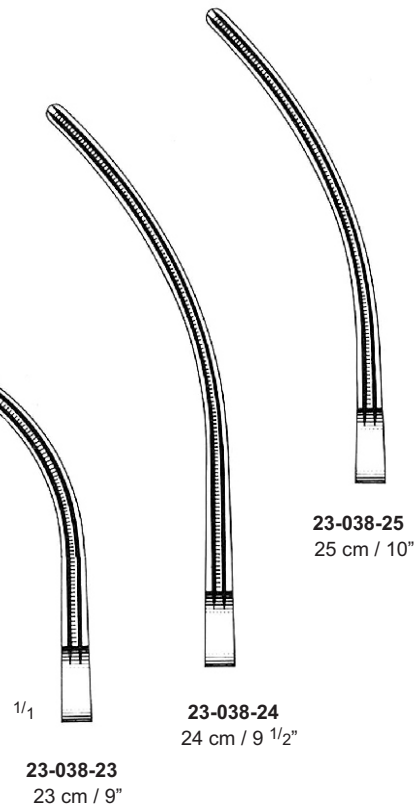

23-038-23  
 23 cm / 9"

23-038-24  
 24 cm / 9 1/2"

23-038-25  
 25 cm / 10"

23-033-23 – 23-033-25 – Bronchus Clamps  
 23-038-23 – 23-038-25 – Aortic Anenrysm / Iliac Artery Clamps

Atraumatic Cardiovascular Forceps

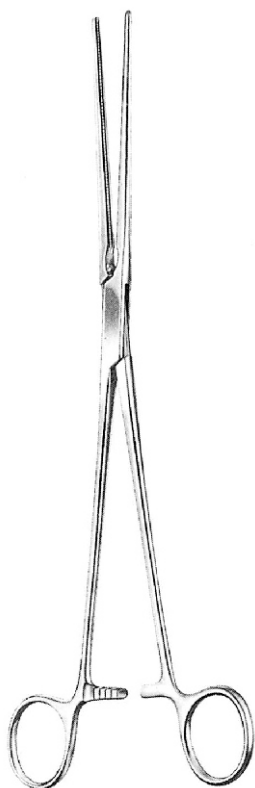

23-039-21 – 23-039-31

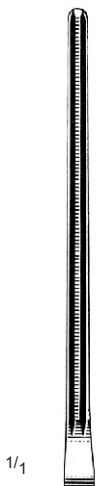

1/1

23-039-21  
 21.5 cm / 8 1/2"



23-039-23  
 23 cm / 9"



23-039-27  
 27 cm / 10 1/2"



23-039-31  
 31.5 cm / 12 1/2"

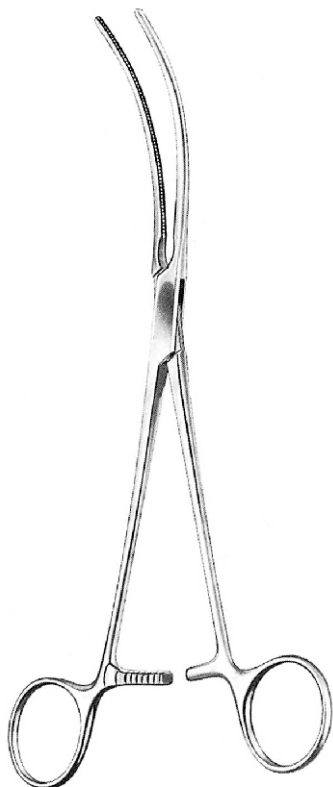

23-040-21 – 23-040-31

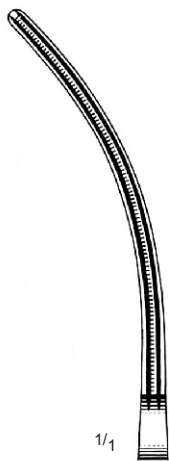

1/1

23-040-21  
 21.5 cm / 8 1/2"

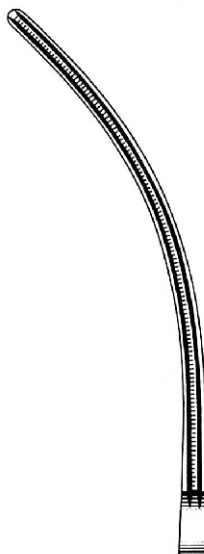

23-040-23  
 23 cm / 9"

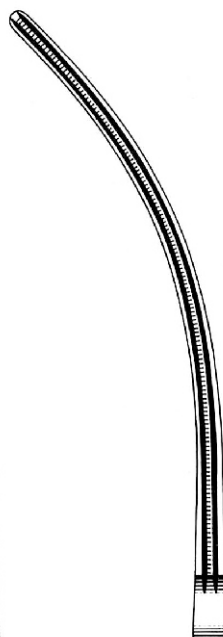

23-040-27  
 27 cm / 10 1/2"

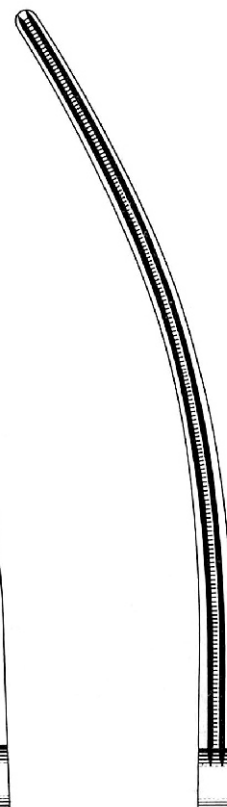

23-040-31  
 31.5 cm / 12 1/2"

23-040-21 – 23-040-31 Coarctation Clamps



Atraumatic Cardiovascular Forceps



DE BAKEY  
 23-041-18 – 23-041-27

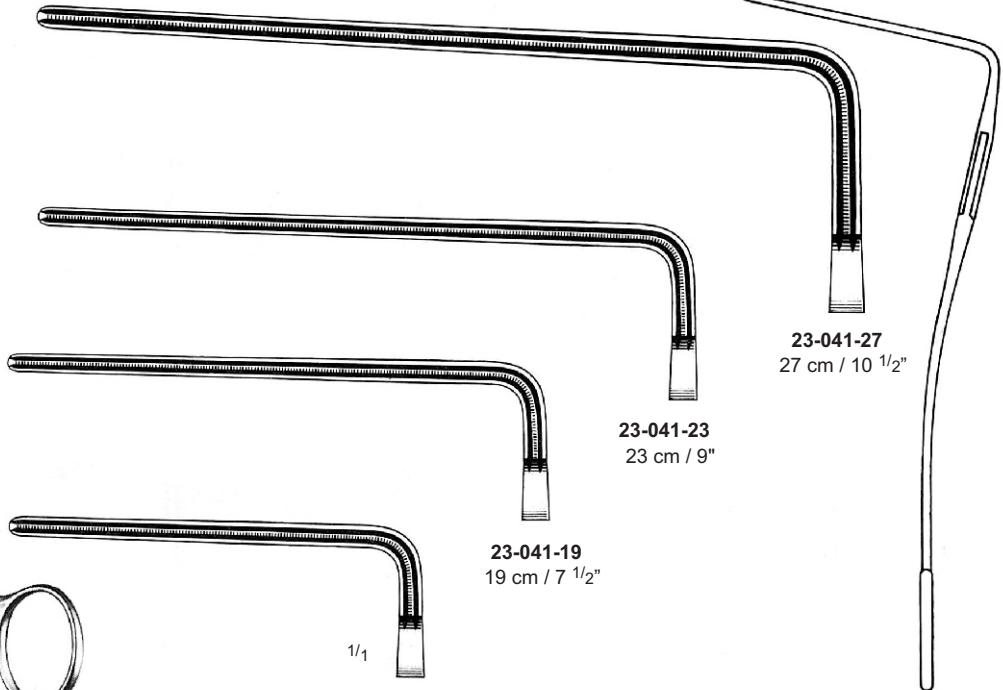

1/1

23-041-19  
 19 cm / 7 1/2"

23-041-23  
 23 cm / 9"

23-041-27  
 27 cm / 10 1/2"

23-041-18  
 18 cm / 7"

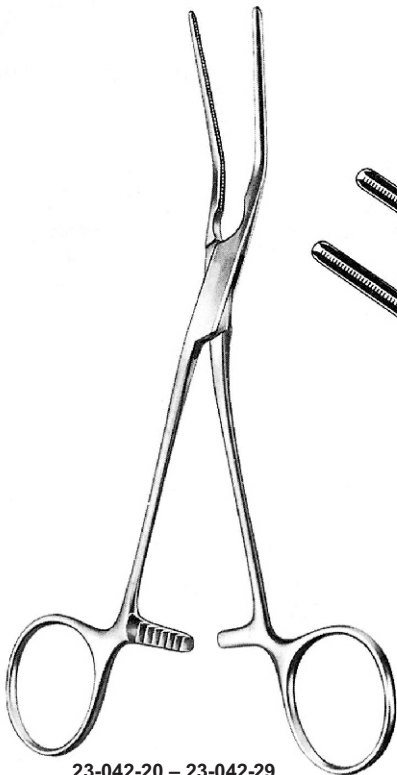

23-042-20 – 23-042-29

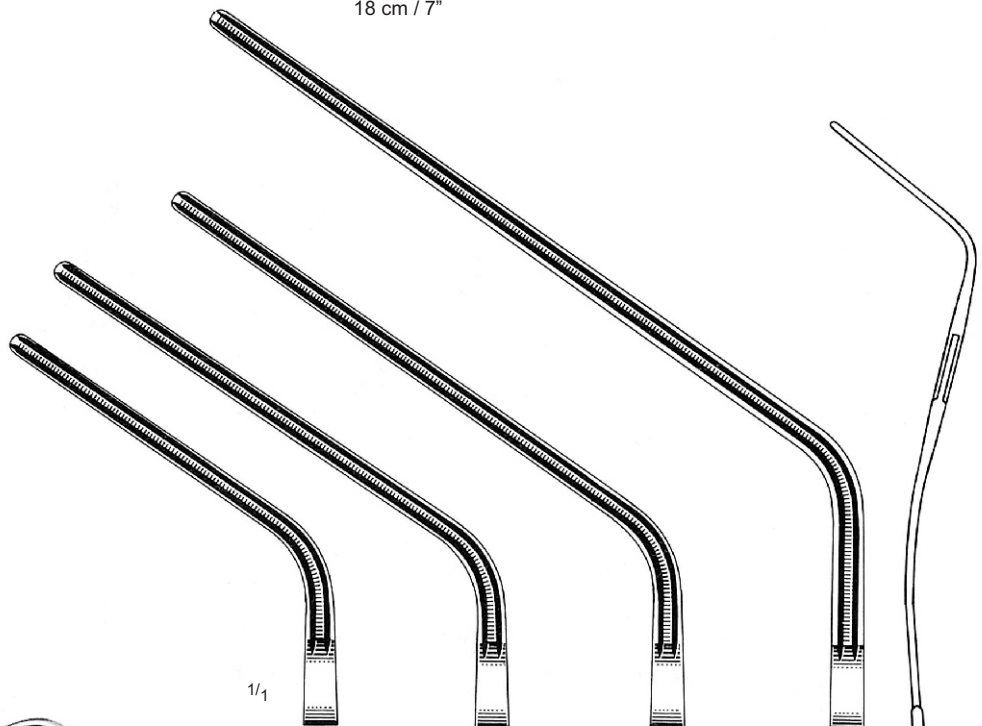

1/1

23-042-20  
 20 cm / 8"

23-042-21  
 21 cm / 8 1/4"

23-042-25  
 25 cm / 10"

23-042-29  
 29 cm / 11 3/4"

23-042-20 – 23-042-29 – Multi Purpose Clamps

Atraumatic Cardiovascular Forceps

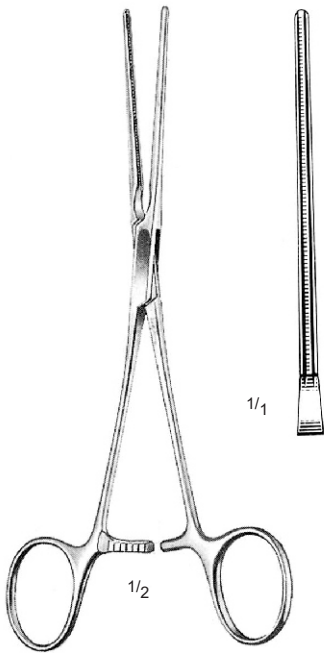

DE BAKEY  
 23-047-17  
 17 cm / 6 3/4"

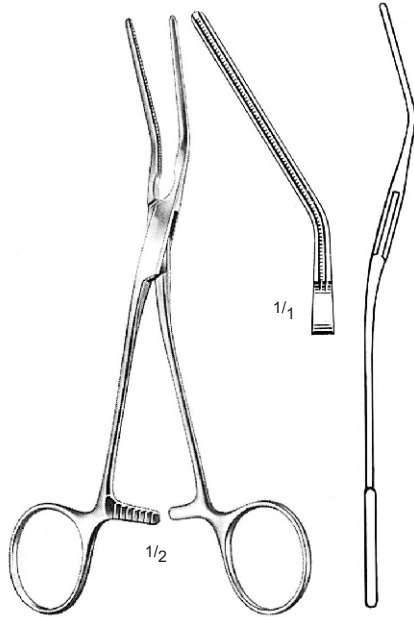

DE BAKEY  
 23-047-16  
 16 cm / 6 1/4"

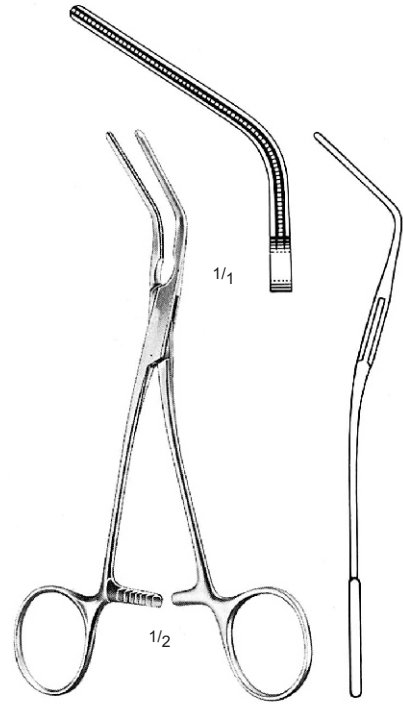

DE BAKEY  
 23-048-15  
 15 cm / 6"

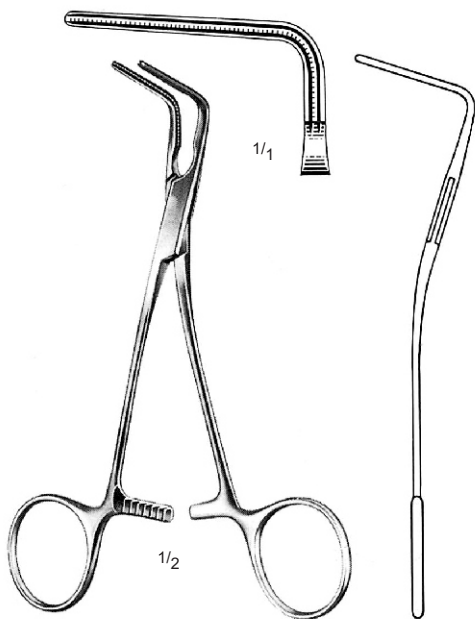

DE BAKEY  
 23-050-15  
 15 cm / 6"

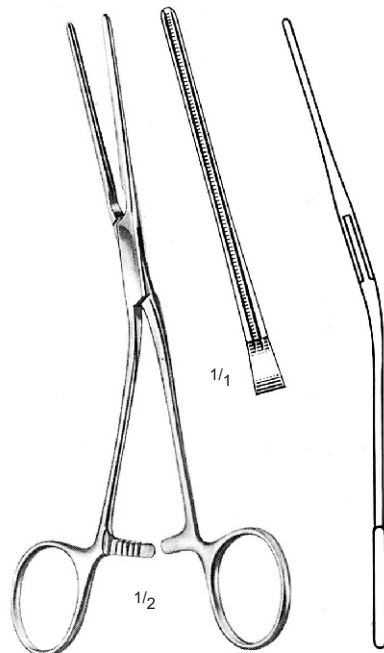

DE BAKEY  
 23-051-17  
 17 cm / 6 3/4"

Atraumatic Cardiovascular Forceps

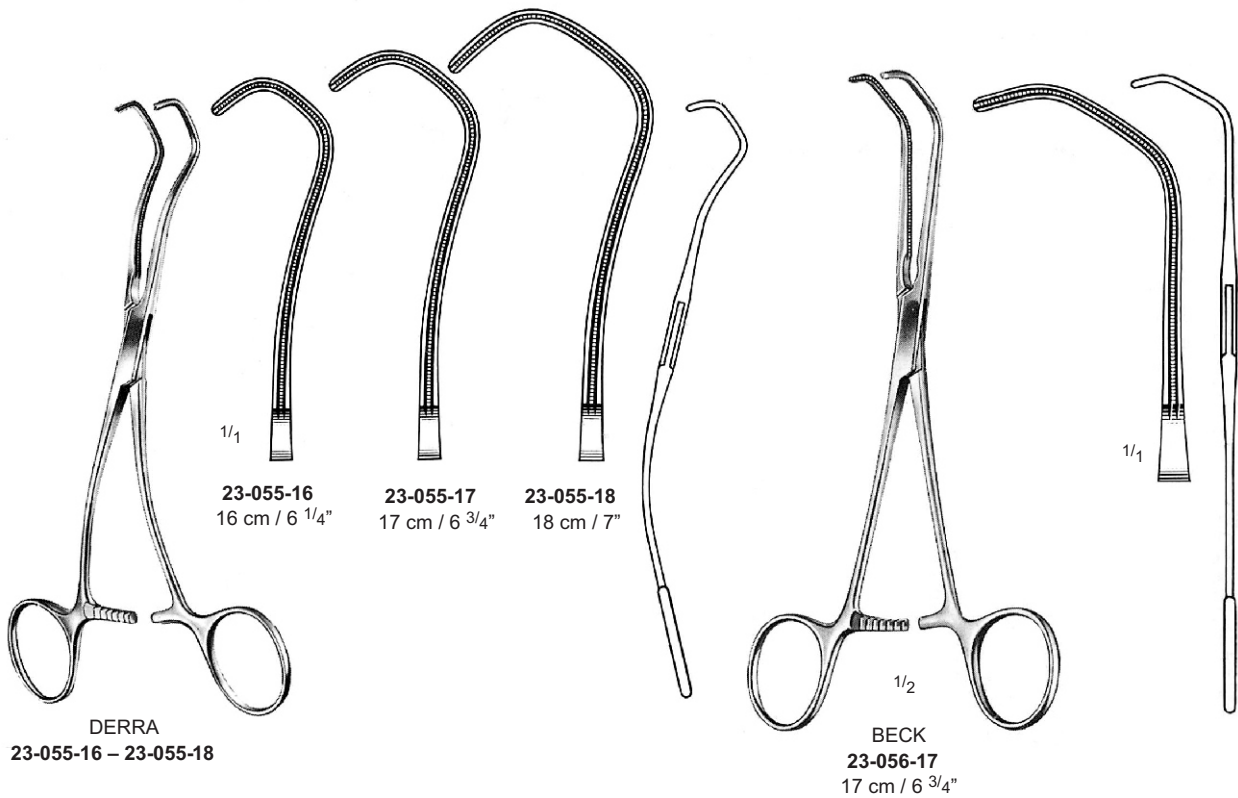
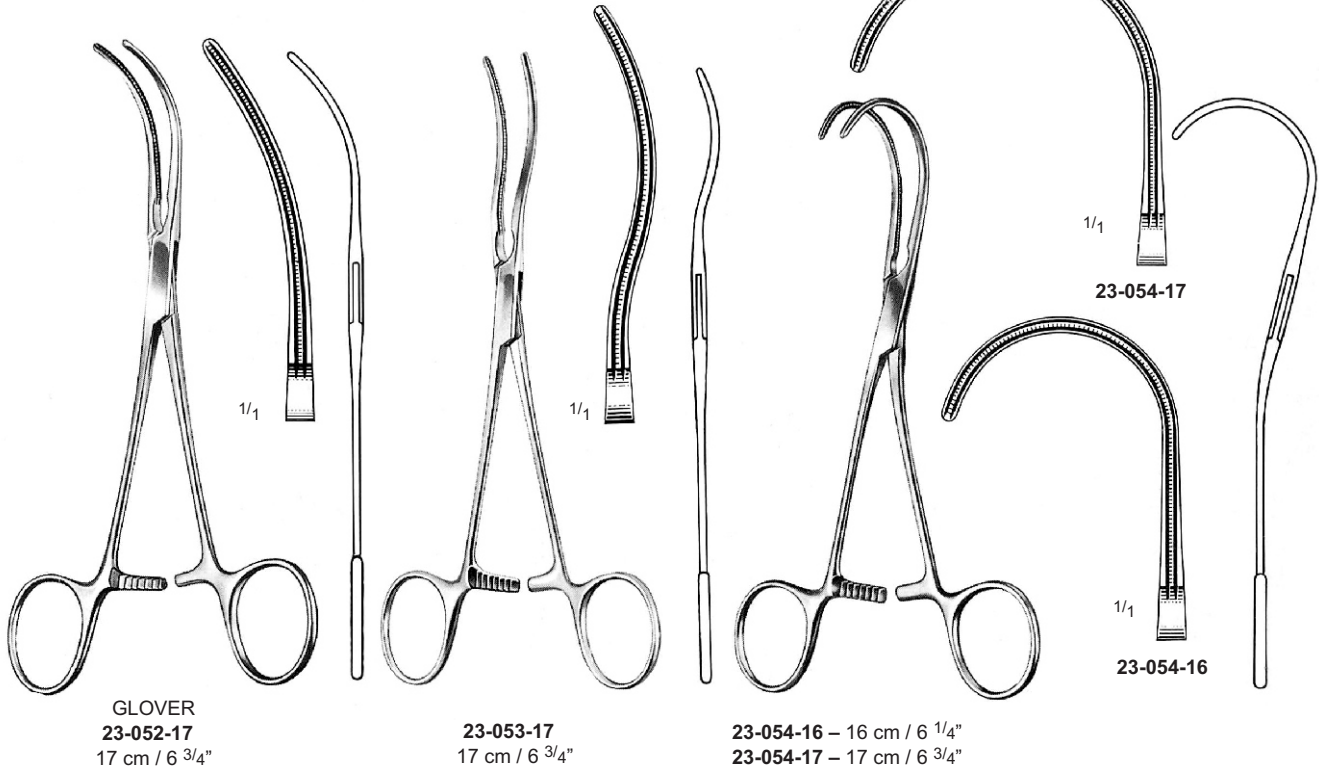

Atraumatic Bulldog Clamps

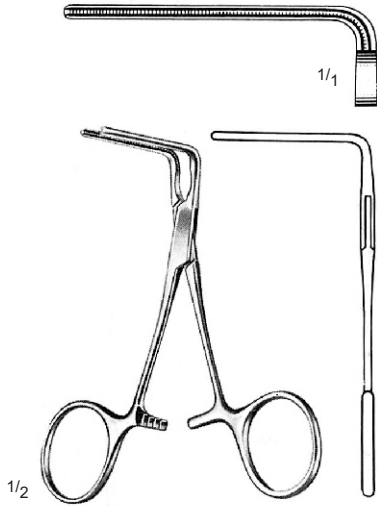

DE BAKEY  
 23-057-10  
 10 cm / 4"

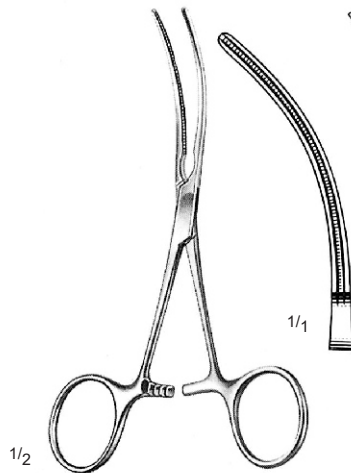

DE BAKEY  
 23-058-11  
 11 cm / 4 1/4"

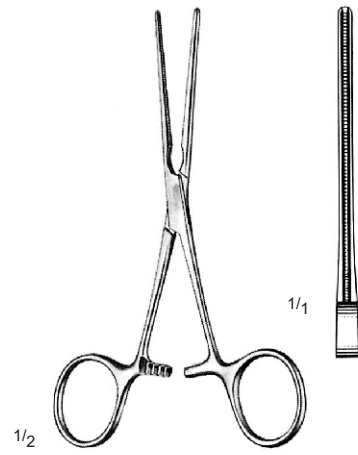

DE BAKEY  
 23-059-12  
 12 cm / 4 3/4"

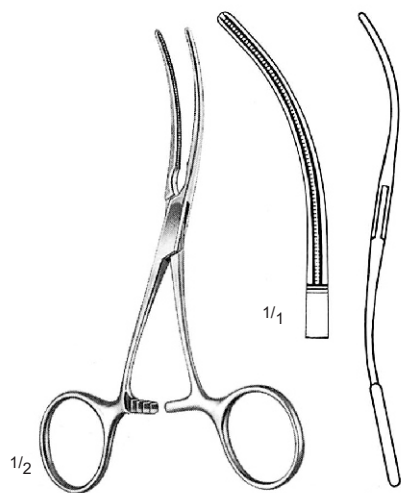

DE BAKEY  
 23-060-12  
 12 cm / 4 3/4"

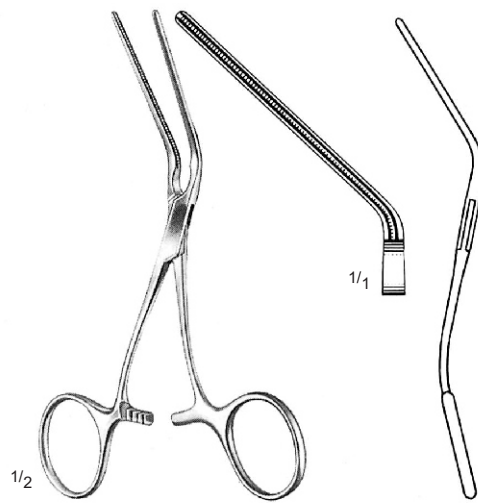

DE BAKEY  
 23-061-13  
 13 cm / 5"

Vascular Dilators

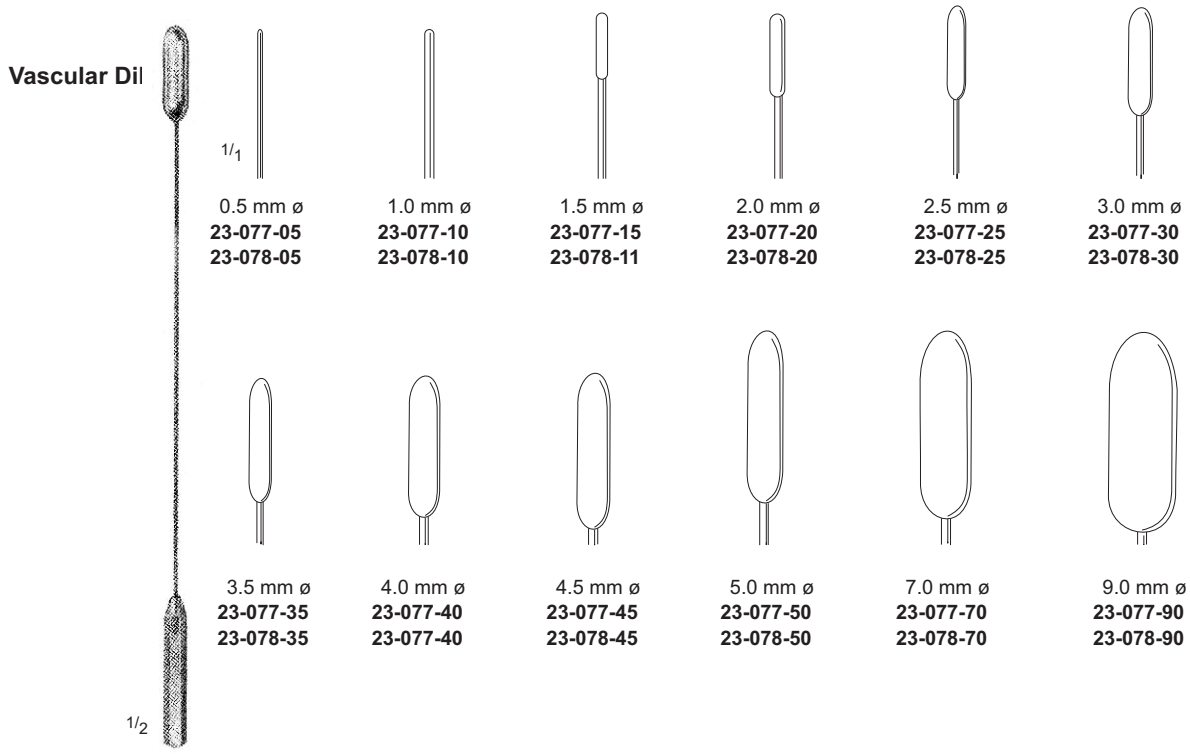

DE BAKEY  
23-077-05 – 23-077-90 = 19 cm / 7 1/2"  
23-078-05 – 23-078-90 = 35 cm / 14"



GARRETT  
14 cm / 5 1/2"  
23-079-90  
Set of 9 pieces from  
23-079-10 to 23-079-50

23-079-10	ø 1,0 mm
23-079-15	ø 1,5 mm
23-079-20	ø 2,0 mm
23-079-25	ø 2,5 mm
23-079-30	ø 3,0 mm
23-079-35	ø 3,5 mm
23-079-40	ø 4,0 mm
23-079-45	ø 4,5 mm
23-079-50	ø 5,0 mm



GARRETT  
21 cm / 8 1/4"  
23-080-90  
Set of 9 pieces from  
23-080-10 to 23-080-50

23-080-10	ø 1,0 mm
23-080-15	ø 1,5 mm
23-080-20	ø 2,0 mm
23-080-25	ø 2,5 mm
23-080-30	ø 3,0 mm
23-080-35	ø 3,5 mm
23-080-40	ø 4,0 mm
23-080-45	ø 4,5 mm
23-080-50	ø 5,0 mm

Aorta Dilators

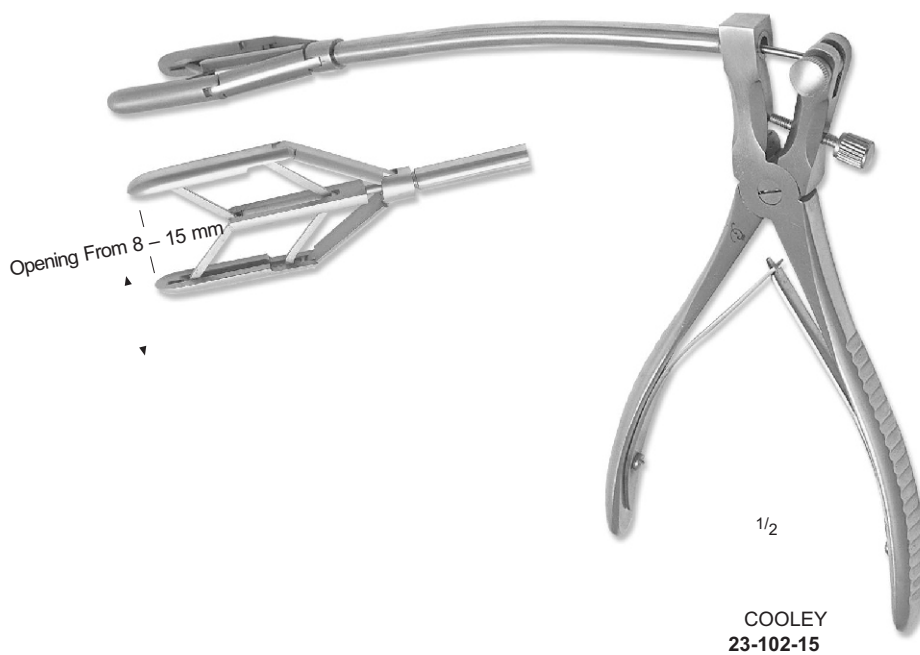
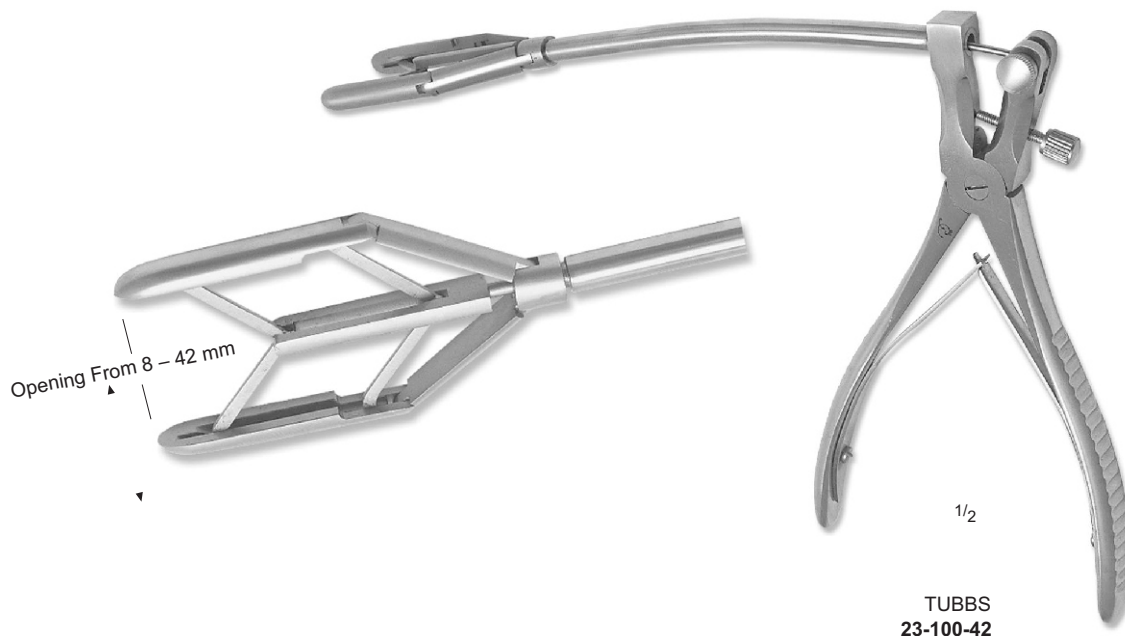

Vascular Scissors, with Tungsten Carbide T/C Inserts

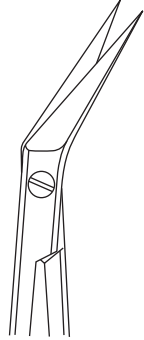

23-083-25  
25°

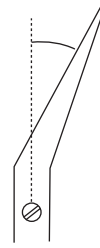

23-084-25  
25°

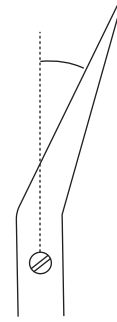

23-085-25  
25°

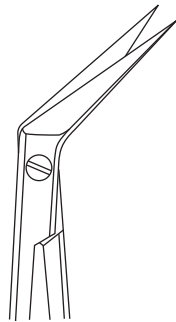

23-083-45  
45°

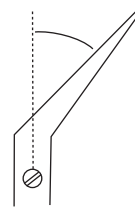

23-084-45  
45°

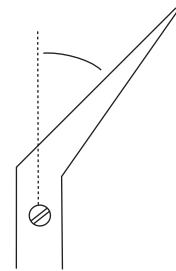

023-085-45  
45°

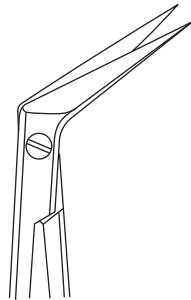

23-083-60  
60°

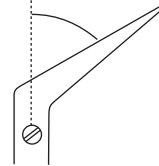

23-084-60  
60°

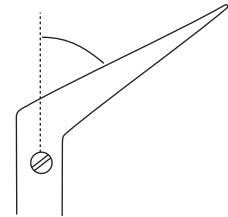

23-085-60  
60°

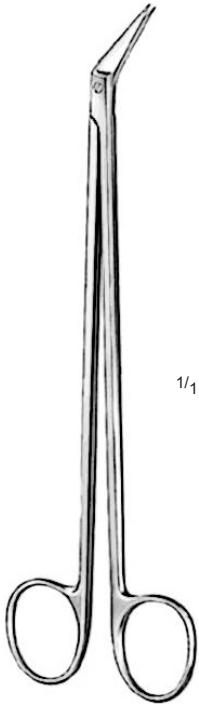

POTTS SMITH  
 23-083-25 – 23-083-60  
 19 cm / 7 1/2"

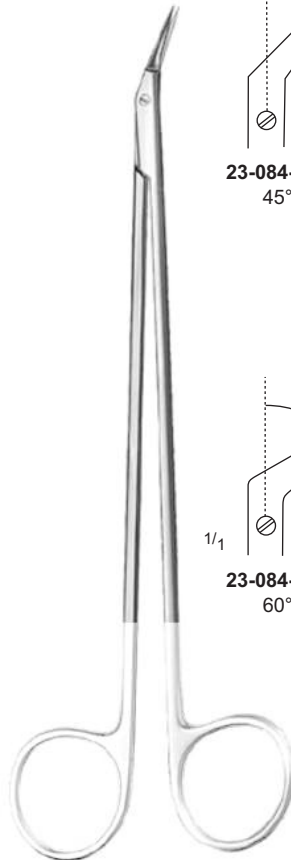

POTTS SMITH, T/C  
 23-084-25 – 23-084-60  
 19 cm / 7 1/2"

23-085-25 23-085-60  
 23 cm / 9"

Vascular Scissors



**23-087-32**  
 18 cm / 7"  
 25°

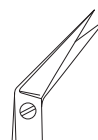

**23-087-34**  
 18 cm / 7"  
 45°

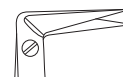

**23-087-39**  
 17 cm / 6 3/4"  
 90°

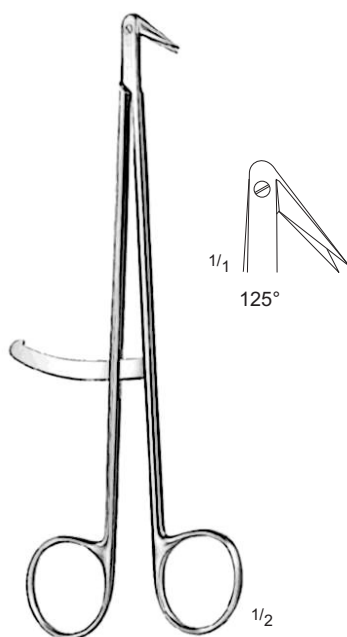

**DIETRICH**  
**23-085-41**  
 18 cm / 7"

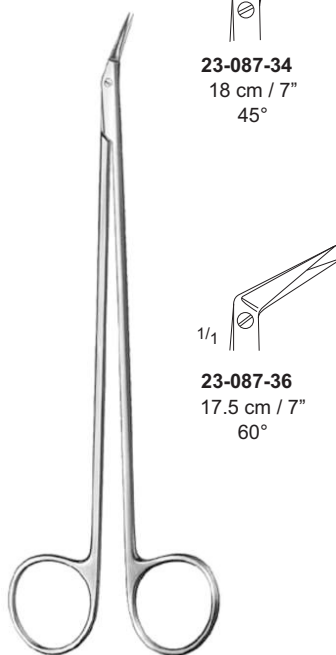

**DIETRICH**  
**23-087-32 – 23-087-40**

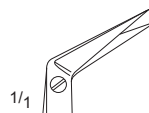

**23-087-36**  
 17.5 cm / 7"  
 60°

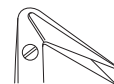

**23-087-40**  
 17 cm / 6 3/4"  
 125°