

Ear Instruments



Ear Polypus Snares, Tuning Forks



1/2
KRAUSE
24-007-16



1/2
KRUSE-VOSS
24-008-16



1/2
HARTMAN
24-011-00
C-128

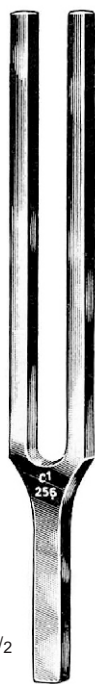

1/2
HARTMAN
24-011-01
C¹ - 256



1/2
HARTMAN
24-011-02
C² - 512



1/2
HARTMAN
24-011-03
C³ - 1024



1/2
HARTMAN
24-011-04
C⁴ - 2048



1/2
HARTMAN
24-011-05
C⁵ - 4096

Tuning Forks

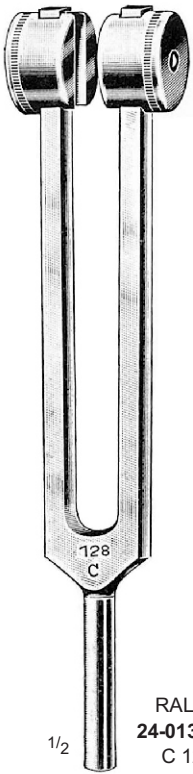

RALKS
24-013-28
C 128

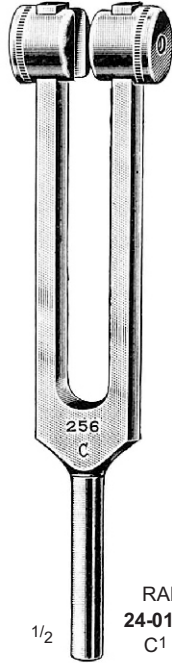

RALKS
24-013-56
C1 256

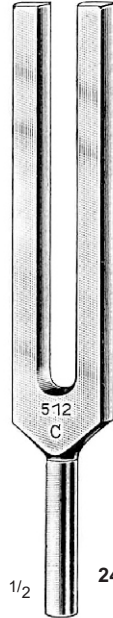

RALKS
24-013-02
C2 512

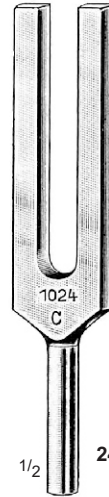

RALKS
24-013-03
C3 1024



RALKS
24-013-04
C4 2048



LUCAE
24-018-10
C 128

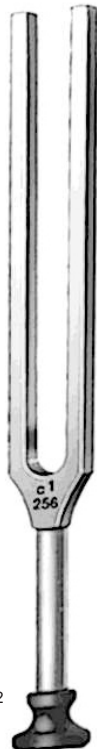

LUCAE
24-018-01
C1 256



LUCAE
24-018-02
C2 512



LUCAE
24-018-03
C3 1024



LUCAE
24-018-04
C4 2048



LUCAE
24-018-05
C5 4096

Ear Specula

○ ø 3 mm
24-028-00
 Fig. 0

○ ø 4 mm
24-028-01
 Fig. 1

1/1 ○ ø 5 mm
24-028-04
 Fig. 2

○ ø 4 mm
24-029-01
 Fig. 1

○ ø 5 mm
24-029-02
 Fig. 2

○ ø 6.0 mm
24-029-03
 Fig. 3

1/1 ○ ø 7.5 mm
24-029-05
 Fig. 4



HARTMAN
 (For Children)
24-028-07
 Set of 3 (FIG 0,1,2)



HARTMAN
 (For Adults)
24-028-03 Set of 3 (Fig 2,3,4)
24-028-04 Set of 4 (Fig 1,2,3,4)

○ ø 4.5 mm
24-032-01
 Fig. 1

○ ø 5.5 mm
24-032-02
 Fig. 2

○ ø 6.5 mm
24-032-03
 Fig. 3

1/1 ○ ø 7.5 mm
24-032-04
 Fig. 4

○ ø 5.5 mm
24-034-01

○ ø 6.5 mm
24-034-02

○ ø 7.5 mm
24-034-03

○ ø 8.5 mm
24-034-04

○ ø 9.5 mm
24-034-05

○ ø 10.5 mm
24-034-06

1/1 ○ ø 11.5 mm
24-034-07



TOYNBEE
 (For Adults)
24-032-11 Set of 3 (Fig 2,3,4)
24-032-14 Set of 4 (Fig 1,2,3,4)



FARRIOR
 (Black)
24-034-01 – 24-034-07

Otoscopes PIKALITE, Ophthalmoscope



Complete Set in leather case
with 2 spare specula



24-041-01



24-041-02



24-041-05

Punche Forceps, Currettes, Elevators

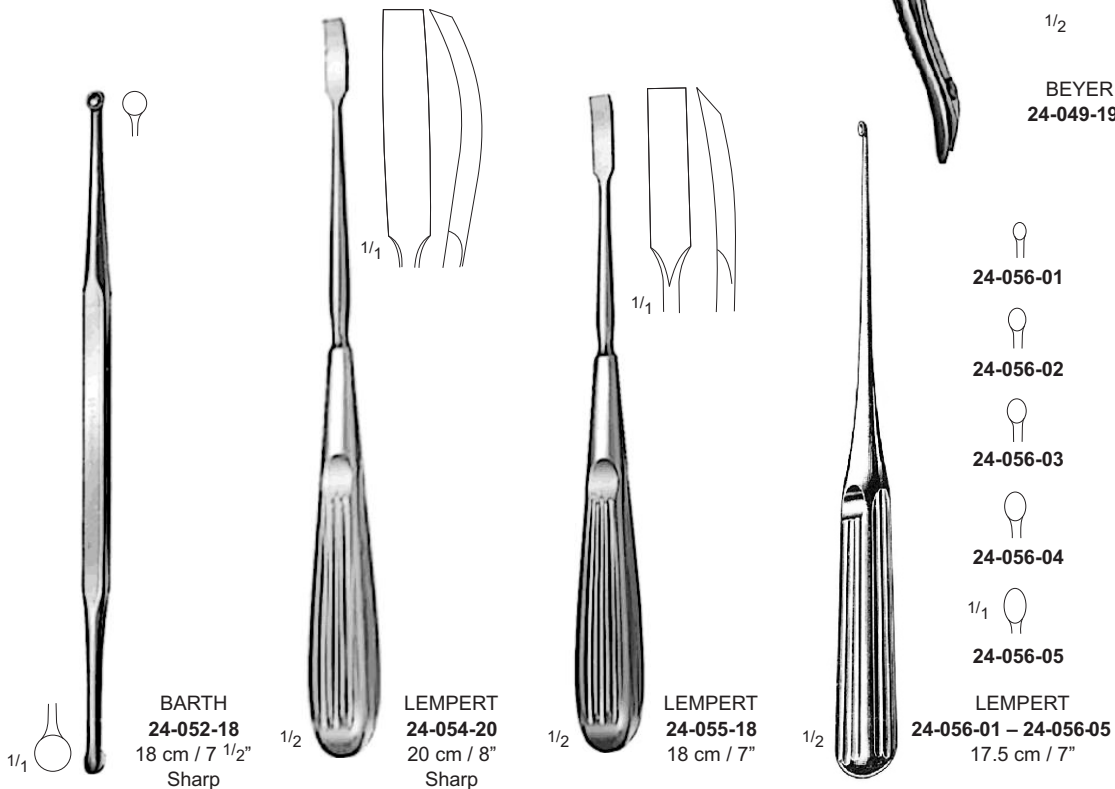
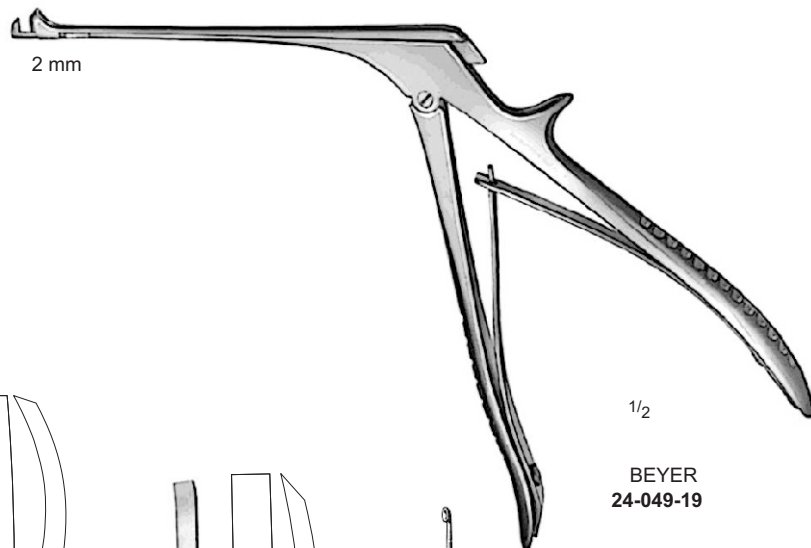
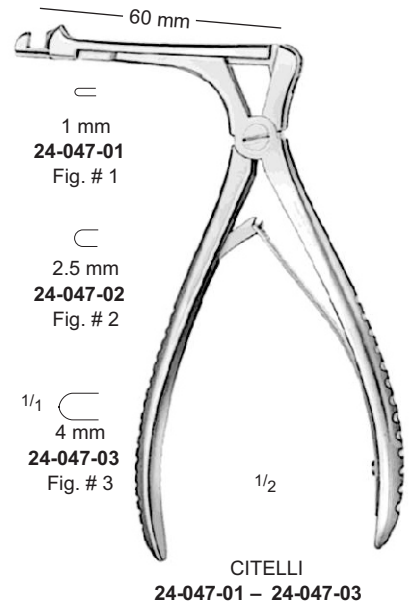
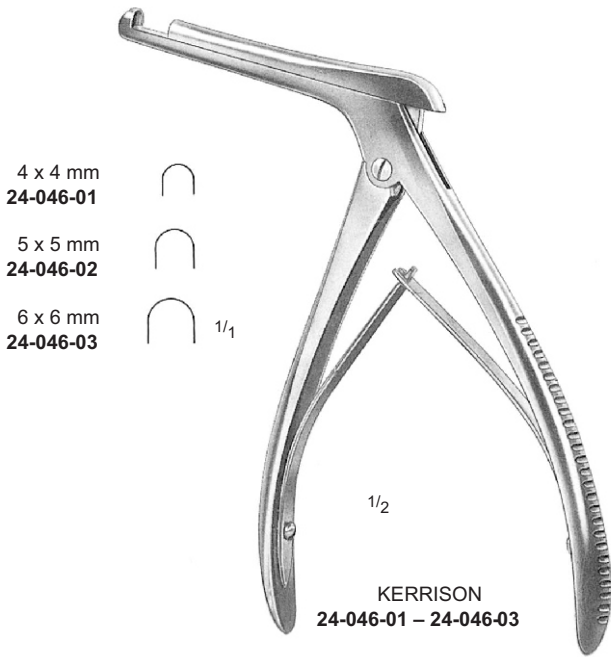

Eustachian Catheters, Ear Syringe, Ear Curettes

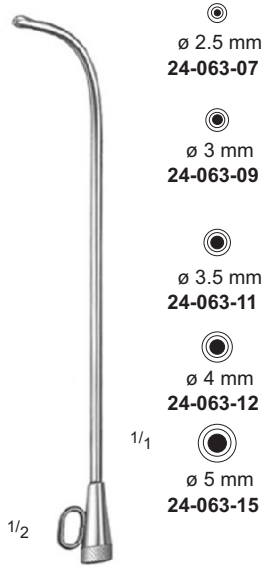

⊙
 ø 2.5 mm
 24-063-07

⊙
 ø 3 mm
 24-063-09

⊙
 ø 3.5 mm
 24-063-11

⊙
 ø 4 mm
 24-063-12

1/1
 ⊙
 ø 5 mm
 24-063-15

HARTMANN
 24-063-07 – 24-063-15
 14 cm / 5 1/2"

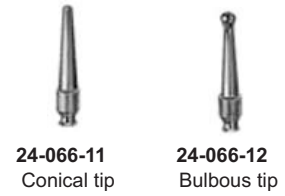

24-066-11
 Conical tip

24-066-12
 Bulbous tip



24-066-10
 Shield

24-066-02 = 50 ml
 24-066-04 = 100 ml
 Ear Syringe Complete with
 1 bulbous and 1 conical tip
 and 1 protective shield.



Sharp



Blunt



BUCK
 24-070-00 – 24-071-03
 16.5 cm / 6 1/2"

Ear Loops, Hooks

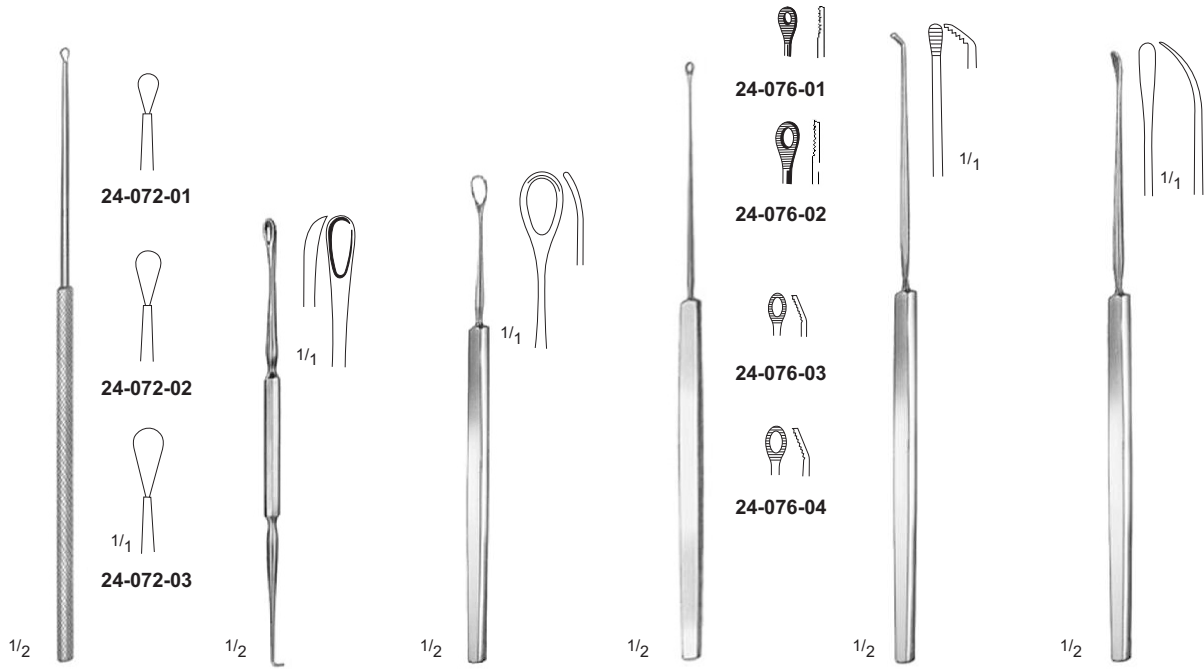

24-072-01

24-072-02

24-072-03

24-076-01

24-076-02

24-076-03

24-076-04

BILLEAU
 24-072-10 – 24-072-30
 16.5 cm / 6 1/4"

GROSS
 24-073-12
 12 cm / 4 3/4"
 Blunt

LANGENBECK
 24-075-13
 13 cm / 5 1/4"

SHAPLEIGH
 24-076-01 – 24-076-04
 13 cm / 5 1/4"

MOLDENHAUER
 24-077-16
 16.5 cm / 6 1/2"

ZAUFAL
 24-078-16
 16 cm / 6 1/4"

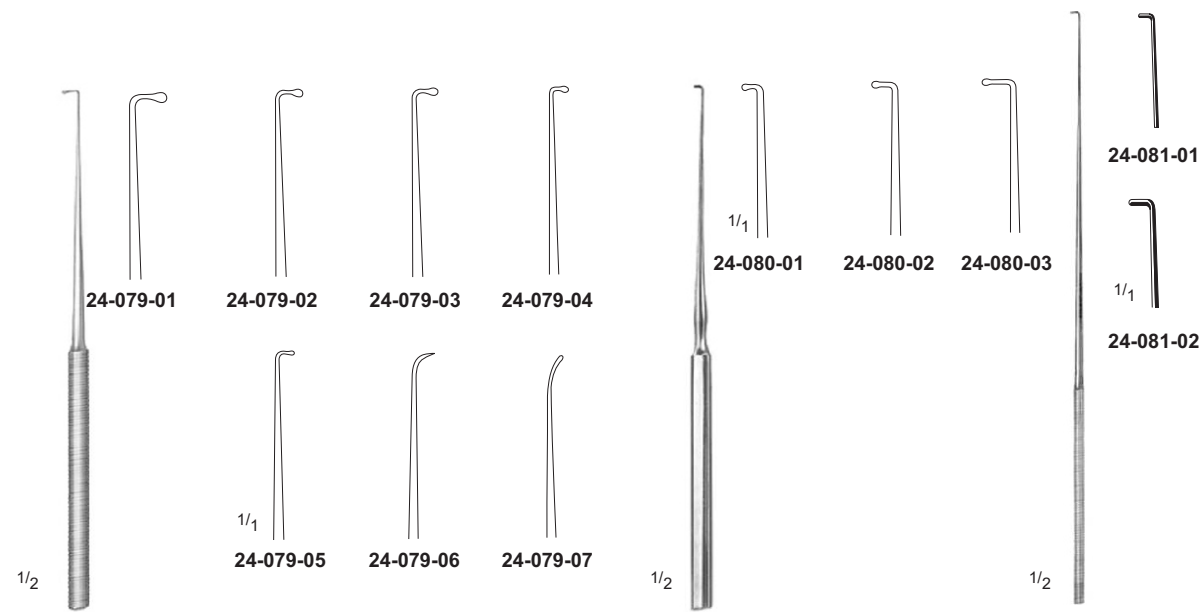

24-079-01

24-079-02

24-079-03

24-079-04

24-079-05

24-079-06

24-079-07

24-080-01

24-080-02

24-080-03

24-081-01

24-081-02

WAGENER
 24-079-01 – 24-079-07
 16.5 cm / 6 1/2"

LUCAE
 24-080-01 – 24-080-03
 14 cm / 5 1/2"

DAY
 24-081-01 – 24-081-02
 16 cm / 6 1/4"

Paracentesis Needles, Ear Dressing Forceps

Vertical Needle

Horizontal Needle

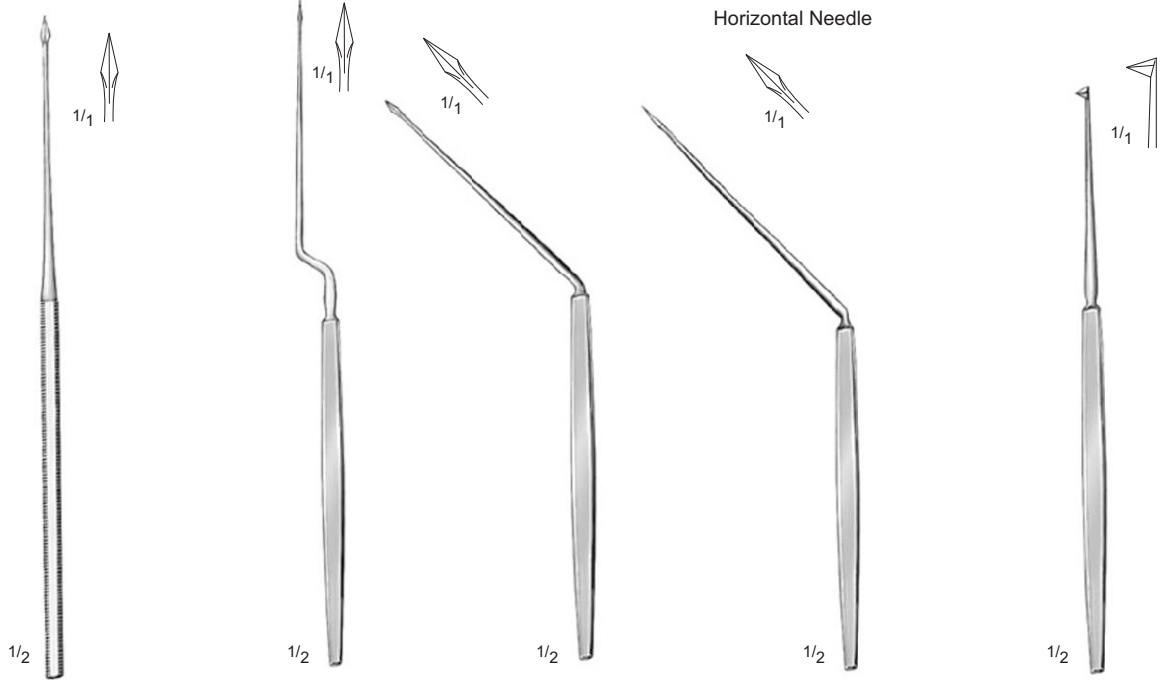

POLITZER
24-082-16
 16 cm / 6 1/4"

POLITZER
24-083-18
 18 cm / 7 1/4"

POLITZER
24-084-16
 16.5 cm / 6 1/2"

POLITZER
24-085-16
 16.5 cm / 6 1/2"

POLITZER
24-086-16
 16 cm / 6 1/4"

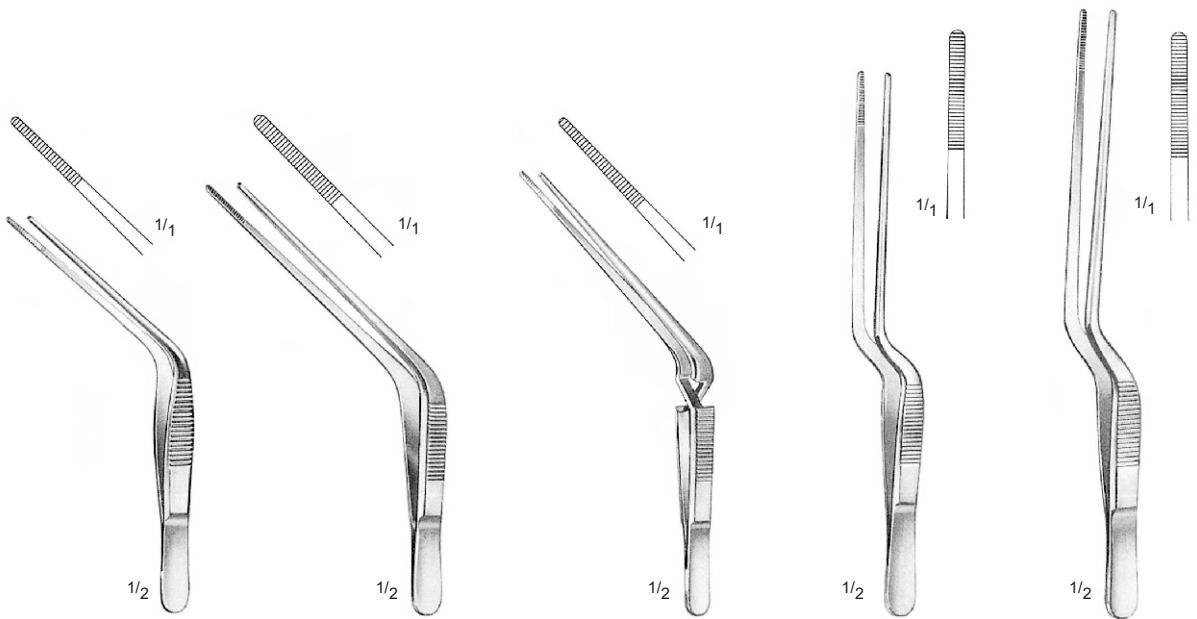

TROELTSCH (WILDE)
24-093-11
 11 cm / 4 1/2"

TROELTSCH (WILDE)
24-094-12
 12 cm / 4 3/4"

TROELTSCH (WILDE)
24-095-13
 13 cm / 5"

LUCAE
24-095-14
 14 cm / 5 1/2"

JANSEN
24-096-16
 16 cm / 6 1/4"

Ear Polypus Forceps, Foreign Body Levers



HARTMANN
 24-100-85
 8.5 cm / 3 1/2"

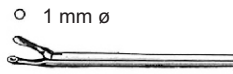

WULLSTEIN
 24-101-20
 8.5 cm / 3 1/2"

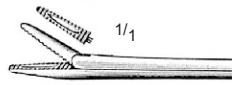

HARTMANN
 24-103-08 = 8.5 cm / 3 1/2"
 24-103-16 = 12 cm / 4 3/4"
 24-103-17 = 14 cm / 5 1/2"
 24-103-16 = 16 cm / 6 1/2"

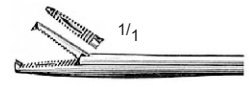

HARTMANN
 24-104-08 = 8.5 cm / 3 1/2"

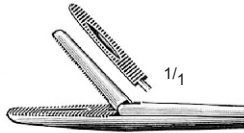

HARTMANN-NOYES
 24-110-09
 9 cm / 3 1/2"

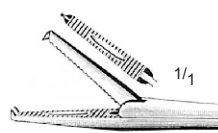

HARTMANN-NOVES
 24-111-09
 9 cm / 3 1/2"



HARTMANN-WEINGARTNER
 24-112-85
 8.5 cm / 3 1/2"

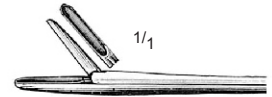

HARTMANN
 24-113-08
 8.5 cm / 3 1/2"

- 2.0 mm Ø
- 2.5 mm Ø
- 3 mm Ø



HARTMANN-WULLSTEIN
 24-115-01 = 2.0 mm Ø
 24-115-02 = 2.5 mm Ø
 24-115-03 = 3.0 mm Ø

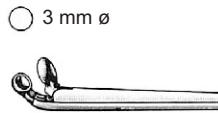

HARTMANN
 24-117-08
 8.5 cm / 3 1/2"



STRUEMPEL
 24-120-08
 8.5 cm / 3 1/2"



STRUYCKEN
 24-121-08
 8.5 cm / 3 1/2"

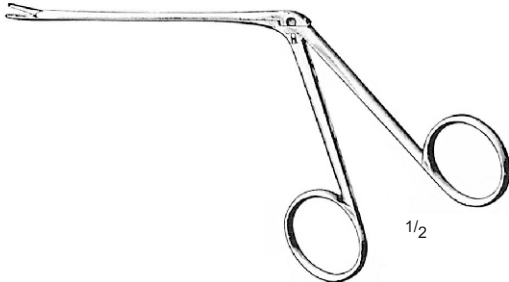

24-100-85 – 24-125-08

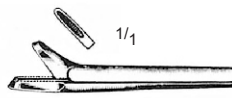

STRUYCKEN
 24-123-08
 8.5 cm / 3 1/2"

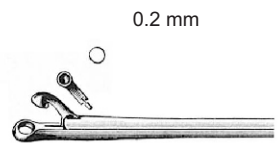

HARTMANN-HOFFMANN
 24-125-08
 8.5 cm / 3 1/2"

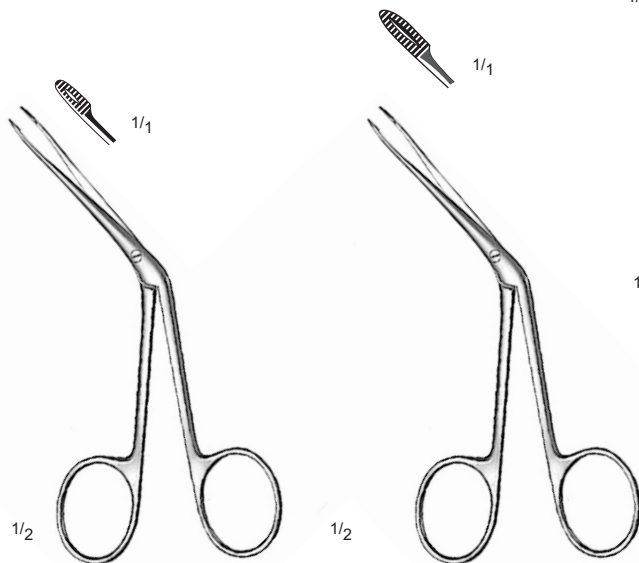

HARTMANN
 24-105-12
 Delicate
 12 cm / 4 3/4"

HARTMANN
 24-105-14
 Standard
 14 cm / 5 1/2"

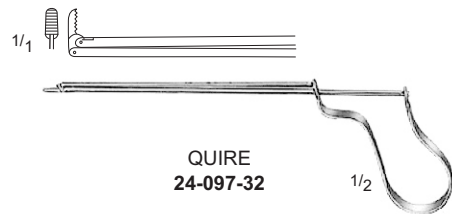

QUIRE
 24-097-32

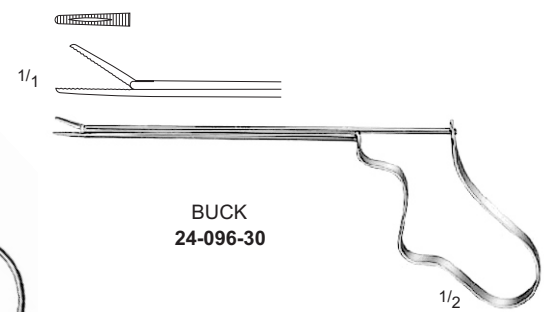

BUCK
 24-096-30

Micro Ear Forceps

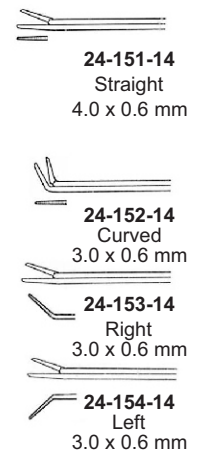
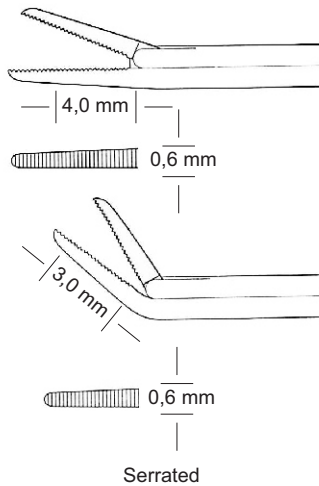
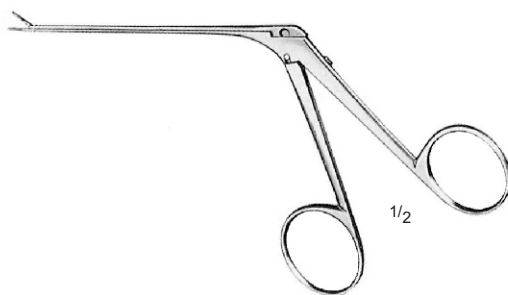
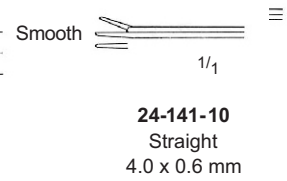
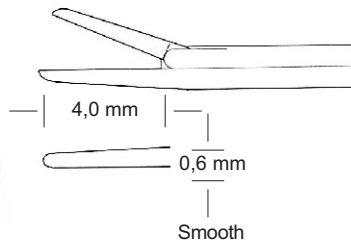
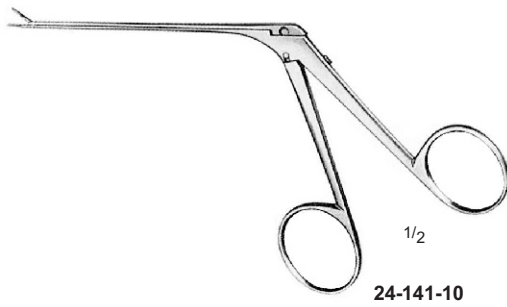
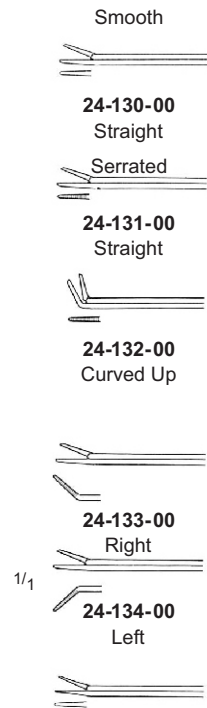
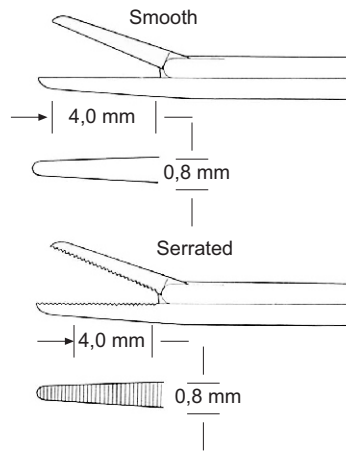
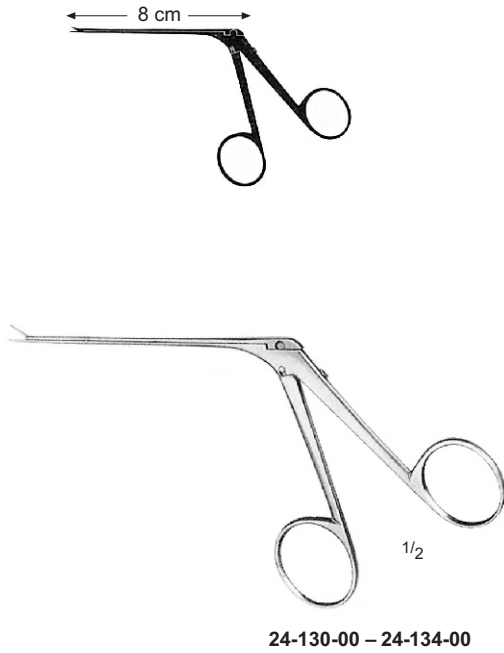

HARTMANN
 24-141-12
 Delicate
 12 cm / 4 3/4"

HARTMANN
 24-151-14 - 24-154-14
 Standard
 14 cm / 5 1/2"

Micro Ear Scissors

