

NASAL

Instruments





KRAUS
31-007-06
26 cm / 10 1/4"

KRAUS VOSS
31-008-26
26 cm / 10 1/4"



EICKEN-KILLIAN
31-001-14
14 cm / 5 1/2"



SIEBENMANN
31-002-15 = ø 1.5 mm
31-002-17 = ø 1.7 mm
31-002-20 = ø 2.0 mm
31-002-25 = ø 2.5 mm
31-002-30 = ø 3.0 mm



31-009-03 – 0.3 mm ø
31-009-40 – 0.4 mm ø
Coil / 10 metre



31-010-03
0.3 mm ø
Package / 100

Dressing and Polypus Forceps

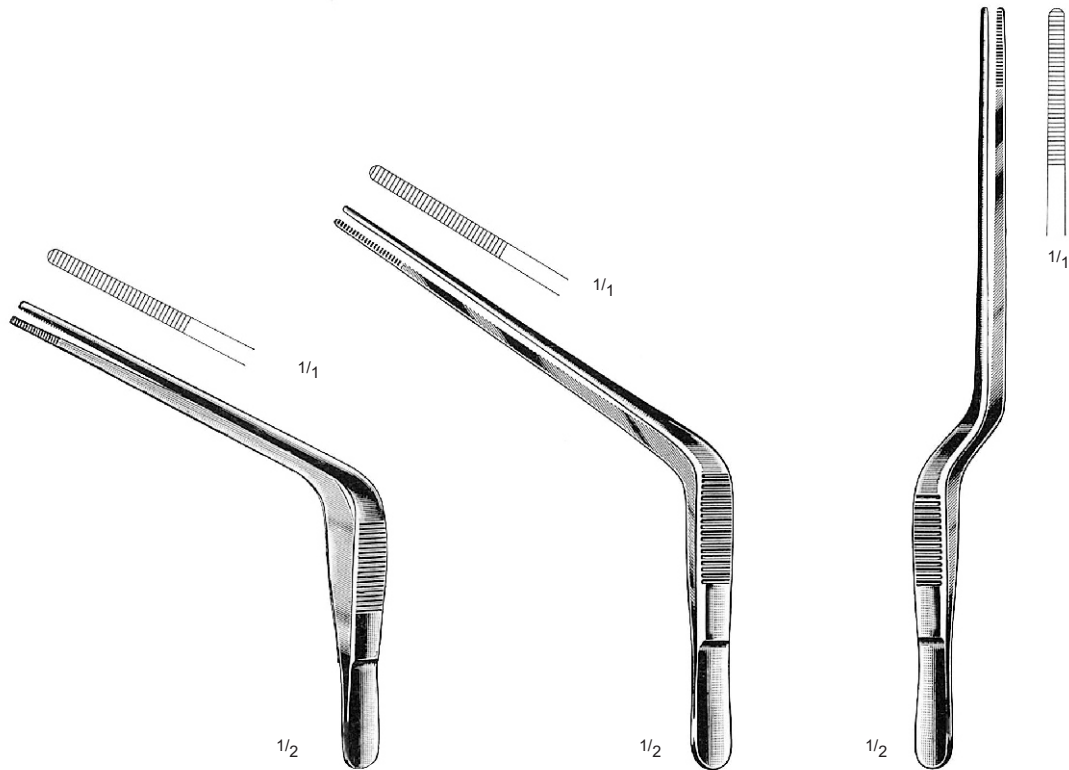

TROELTSCH
 31-101-15
 15 cm / 6"

TROELTSCH
 31-102-18
 18 cm / 7"

GRUENWALD (JANSEN)
 31-103-20
 20 cm / 8"

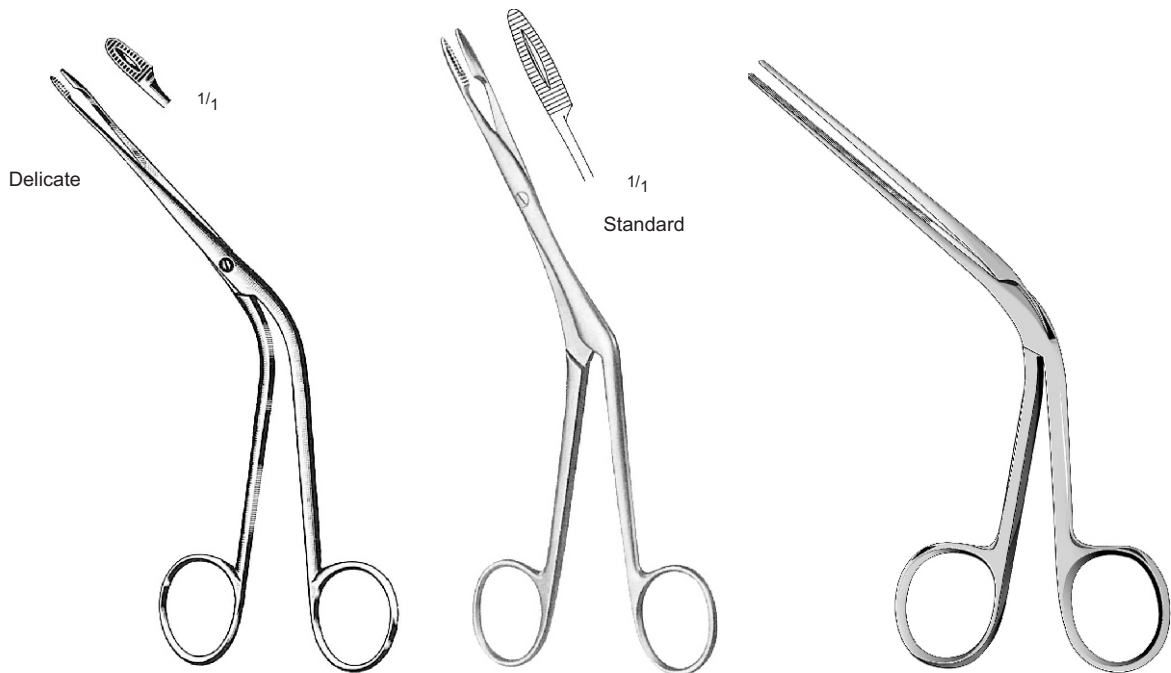

HARTMANN
 31-104-16
 16 cm / 6 1/4"

HARTMANN
 31-105-20
 20 cm / 8"

TILLEY
 31-107-17
 17 cm / 6 3/4"

Nasal Specula

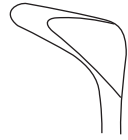
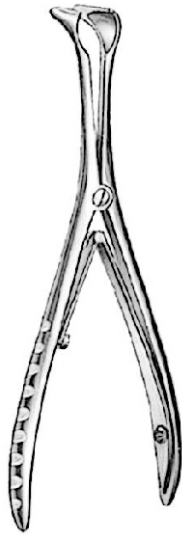

16 mm Blade

TIECK-HALLE
31-109-13
13.5 cm / 5 1/4"

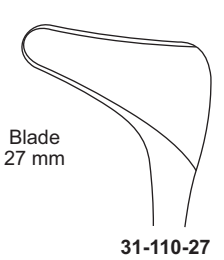

Blade
27 mm

31-110-27

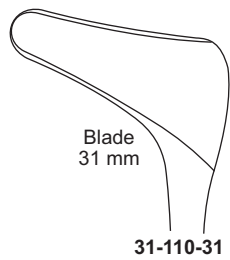

Blade
31 mm

31-110-31

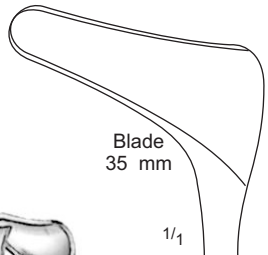

Blade
35 mm

1/1

31-110-35

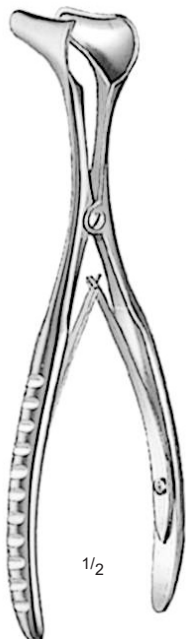

1/2

HARTMANN-HALLE
31-110-27 – 31-110-31
15 cm / 6"



31-111-85
3
85 mm

31-111-75
3
75 mm

31-111-50
2
50 mm

1/1

31-111-35
1
35 mm



1/2

COTTLE
31-111-35 – 31-111-85
15 cm / 6"

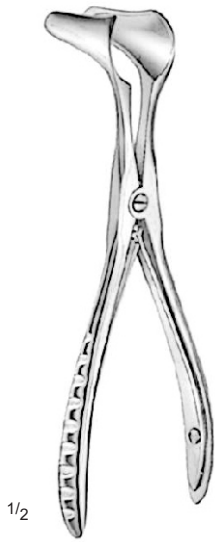

1/2
KILLIAN
31-114-35 – 31-114-90
 14 cm / 5 1/2"

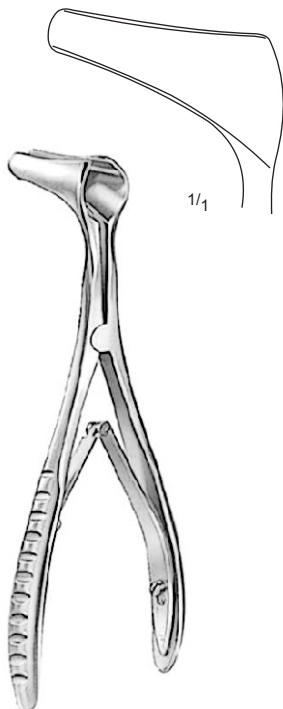
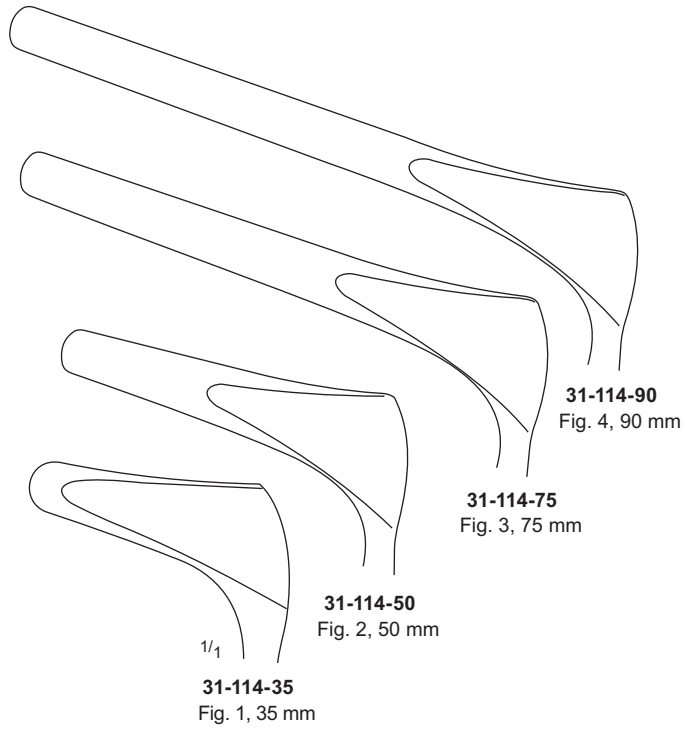

1/1
VIENNA PATTERN
31-116-16
 15 cm / 6"

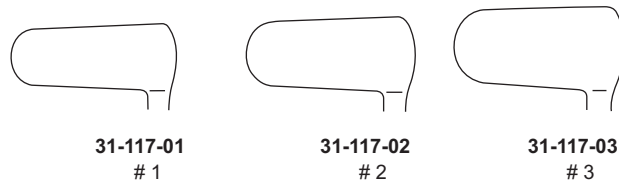

Nasal Scissors, Septum Knives, Septum Elevators

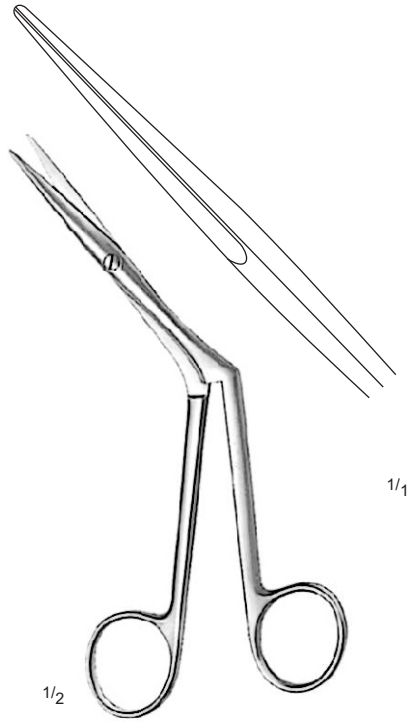

HEYMANN-KNIGHT
31-117-18
18 cm / 7"

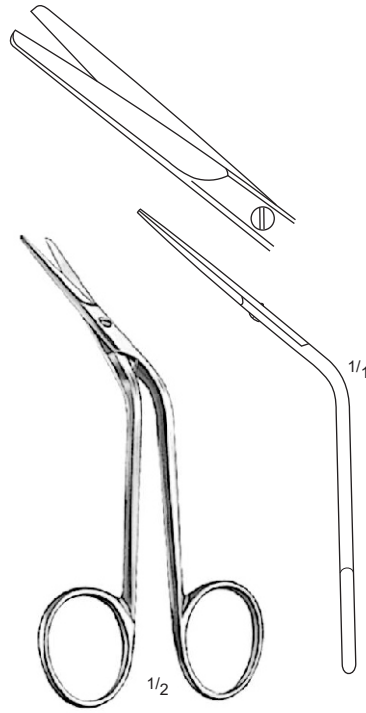

FOMON
31-150-15
15 cm / 6"

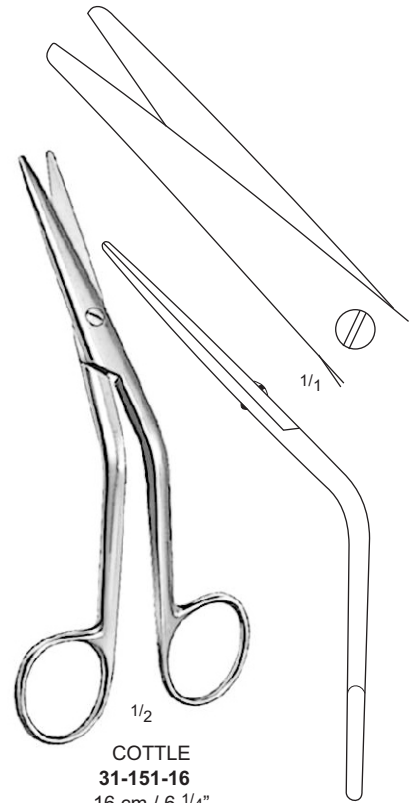

COTTLE
31-151-16
16 cm / 6 1/4"



BLALENGER
31-121-03 — 31-121-05
20 cm / 8"



31-121-03
31-122-03
3.0 mm

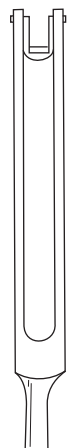

31-121-04
31-122-04
4.0 mm



31-121-05
31-122-05
5.0 mm

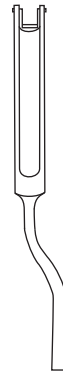

BLALENGER
Bayonet Shape
31-122-03 — 31-122-05
20 cm / 8"



FREER
31-128-21
21 cm / 8 1/4"



Septum Elevators, Compression Forceps

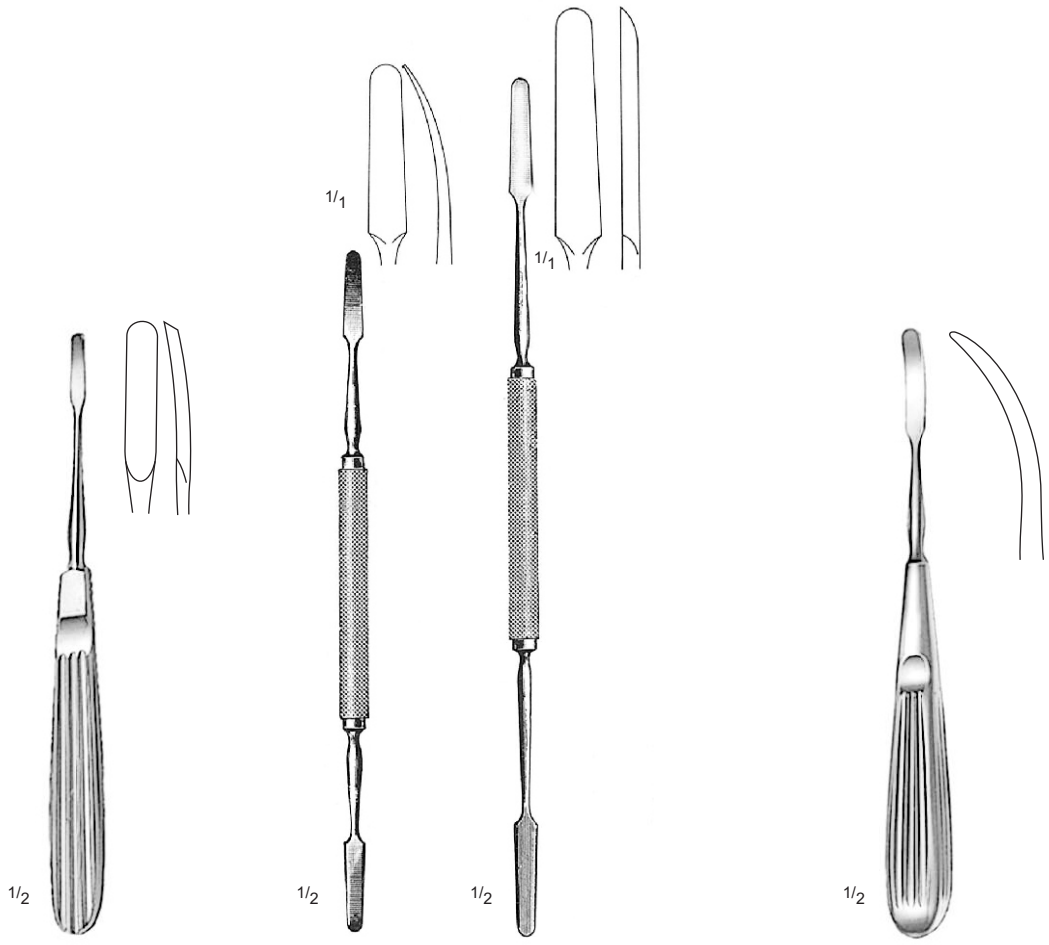

JOSEPH
31-033-16
16 cm / 6 1/4"

KILLIAN
31-034-18
18 cm / 7"

KILLIAN
31-034-22
22 cm / 8 3/4"

JOSEPH
31-035-16
16 cm / 6 1/4"

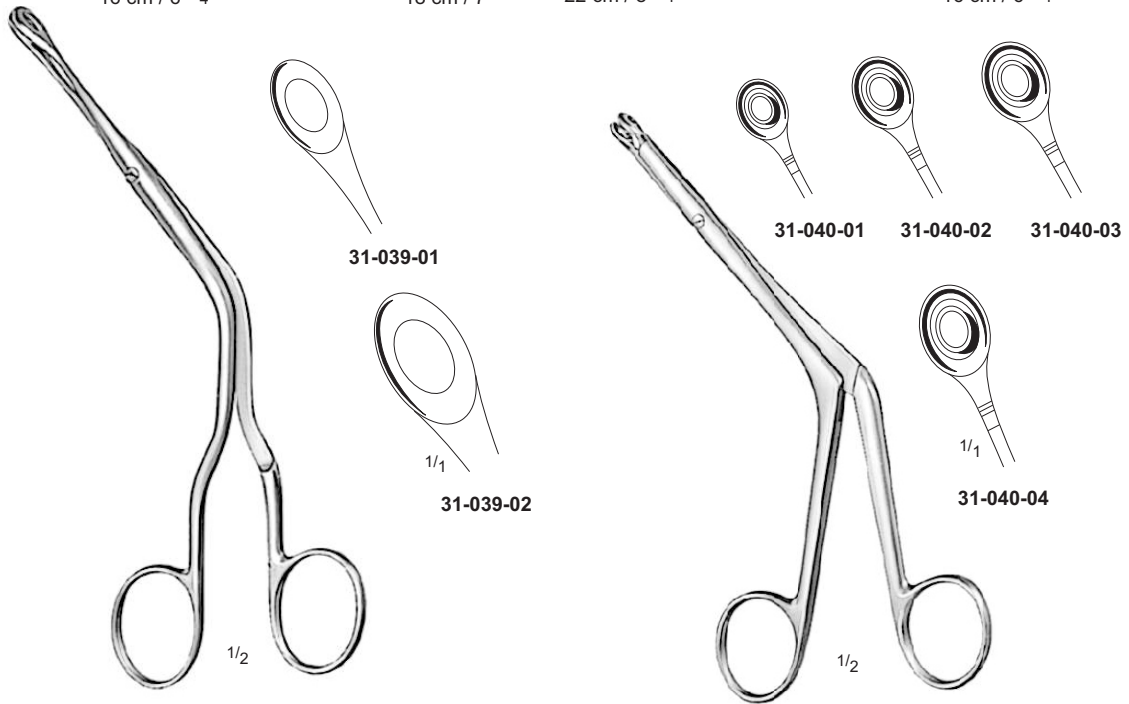

LUC
31-039-21 – 31-039-22
20 cm / 8"

BRUENINGS
31-040-01 – 31-040-04
19 cm / 7 1/2"

Nasal Cutting Forceps

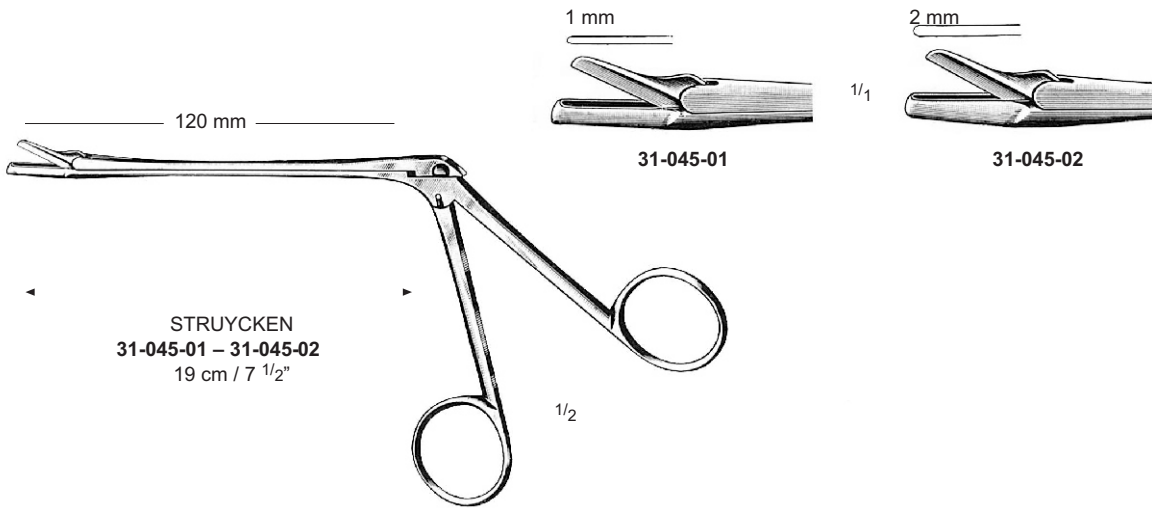
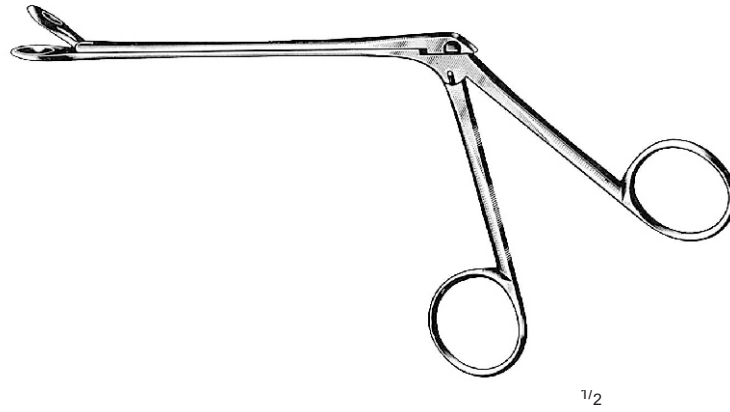

HARTMAN
31-042-05 – 31-042-11
19 cm / 7 1/2"

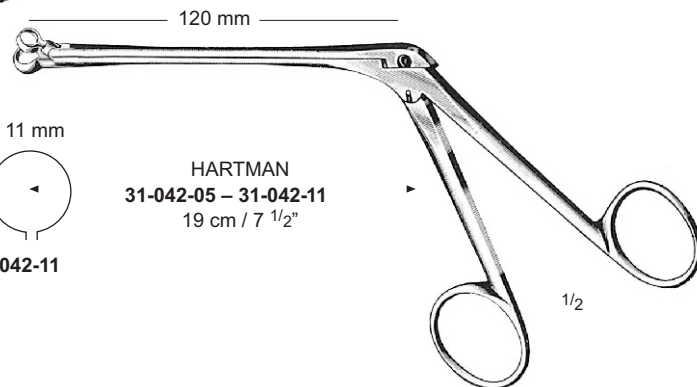

Septum Compression Forceps, Punch Forceps, Rhinoplastic Instruments



JANSEN MIDDLETON
31-049-19
19 cm / 7 1/2"

- 3 mm
31-065-03
- 4 mm
31-065-04
- 5 mm
31-065-05
- 6 mm
31-065-06



KERRISON
31-065-03 - 31-065-06
20 cm / 8"



FOMON
31-101-15
15 cm / 6"



JOSEPH
31-108-15
15 cm / 6"



CONVERSE
31-109-12
12 cm / 4 3/4"

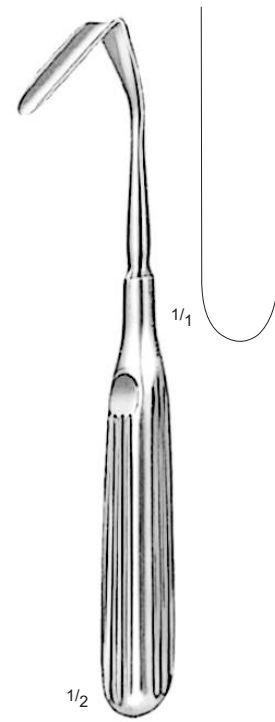

AUFRICHT
31-110-19
19 cm / 7 1/2"

Rhinoplastic Instruments

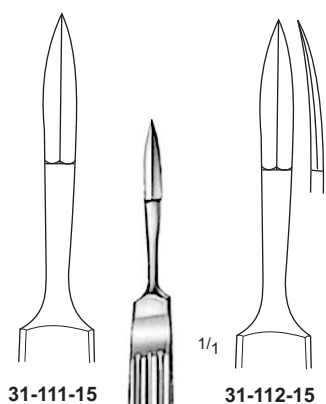

31-111-15

31-112-15

1/2

JOSEPH
31-111-15 – 31-112-15
15 cm / 6 1/4"



JOSEPH
31-113-16
15 cm / 6 1/4"

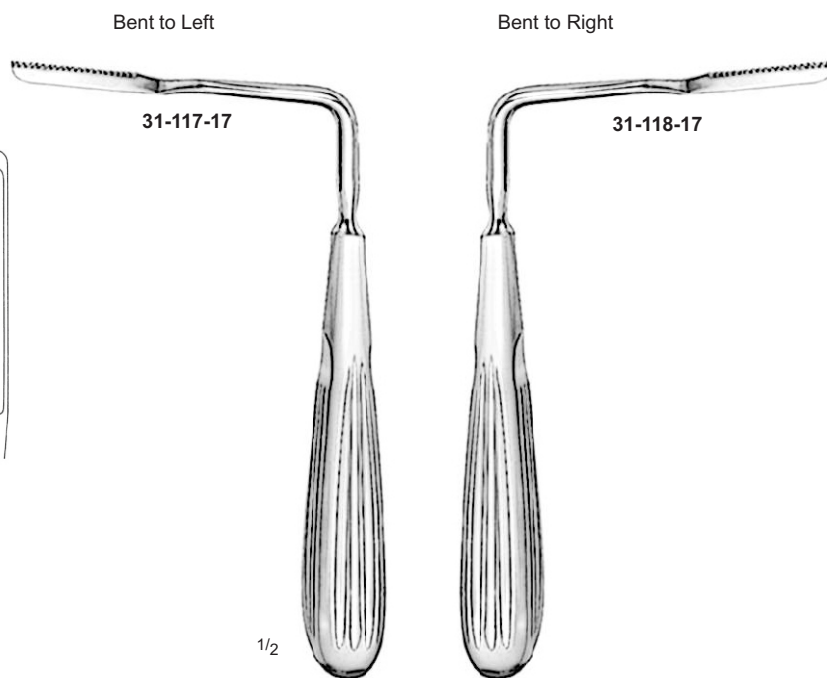

Bent to Left

31-117-17

Bent to Right

31-118-17

1/2

JOSEPH
31-117-17 – 31-118-17
17 cm / 6 3/4"

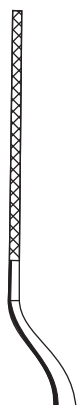

31-119-01

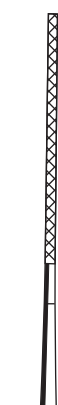

31-119-02

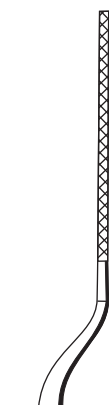

31-119-03

1/2

JOSEPH
31-119-01 – 31-119-03
19 cm / 7 1/2"

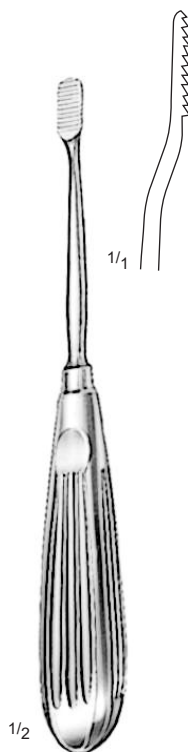

1/2

LEWIS
31-124-26
18 cm / 7"



1/1



1/2

AUFRICHT
31-125-21 – 31-126-21
21 cm / 8 1/4"

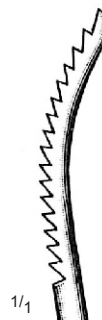

1/1

31-125-21

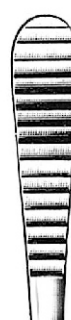

1/1

31-126-21

Rhinoplastic Instruments

