

MOUTH & THROAT

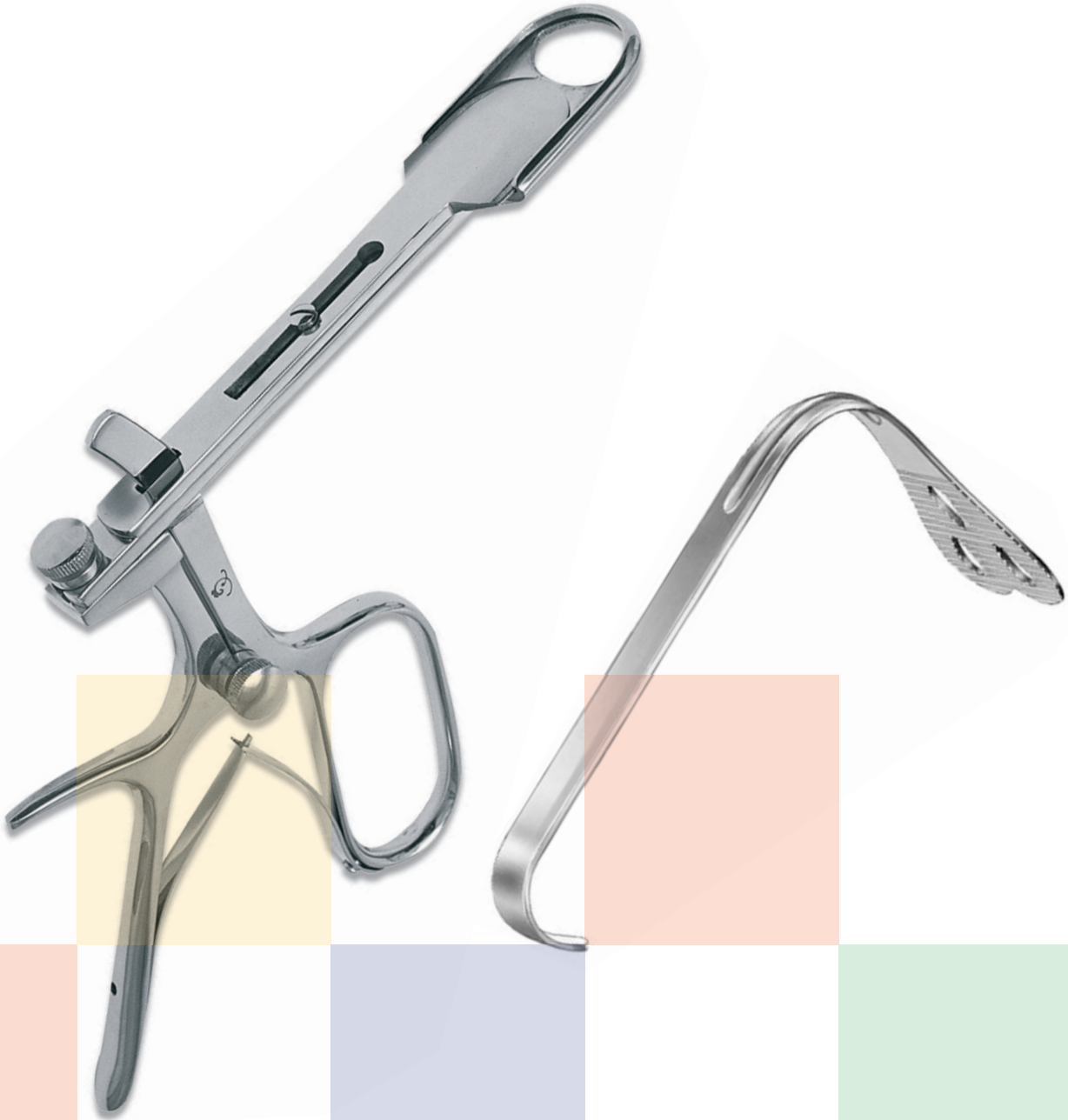

Tonsil Snares, Punch Forceps

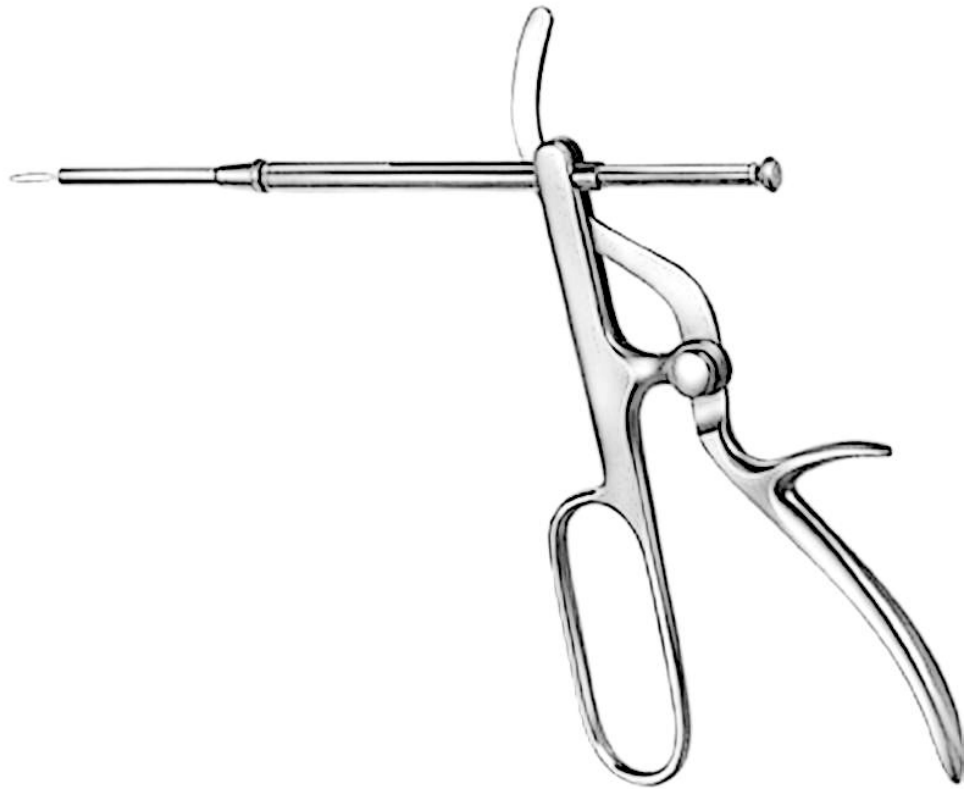

EVES
 32-007-28
 28 cm / 11"

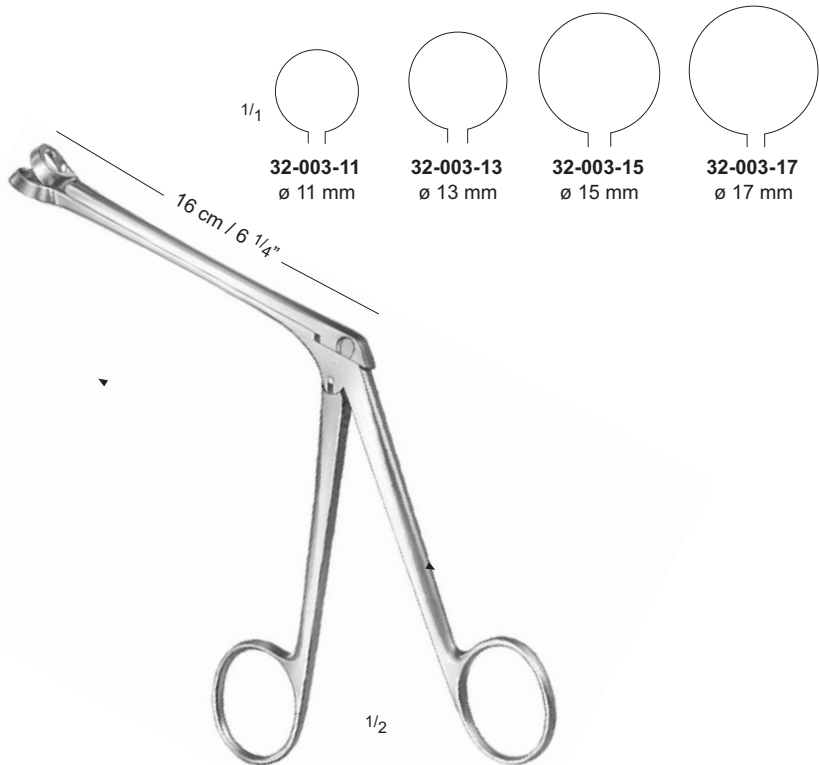

32-003-11
 ø 11 mm

32-003-13
 ø 13 mm

32-003-15
 ø 15 mm

32-003-17
 ø 17 mm

HARTMANN
 32-003-11 – 32-003-17

Tonsil Seizing Forceps, Scissors, Enucleators, Retractors

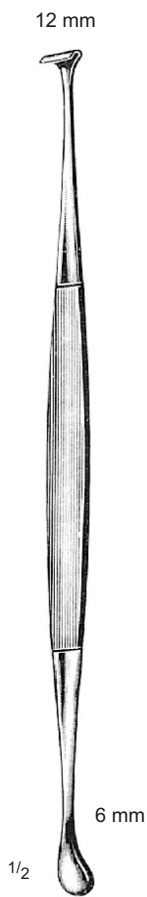
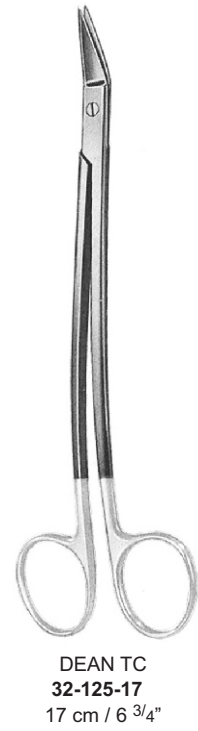
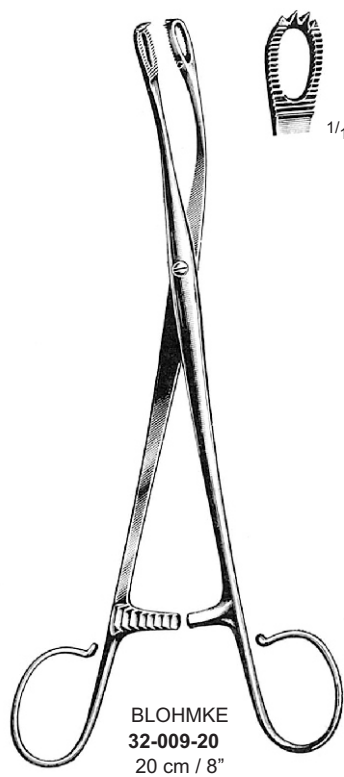
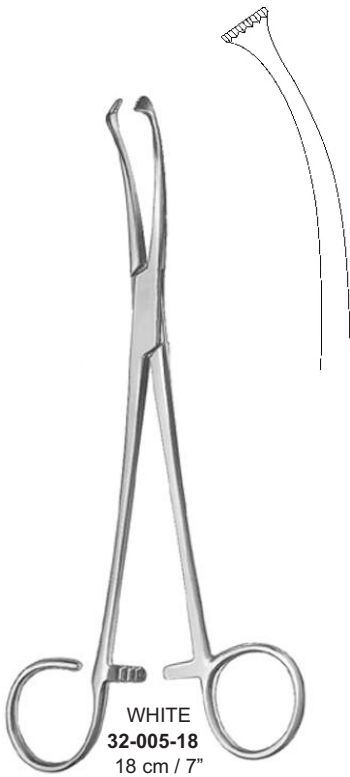

HURD
 32-017-22
 22.5 cm / 9"

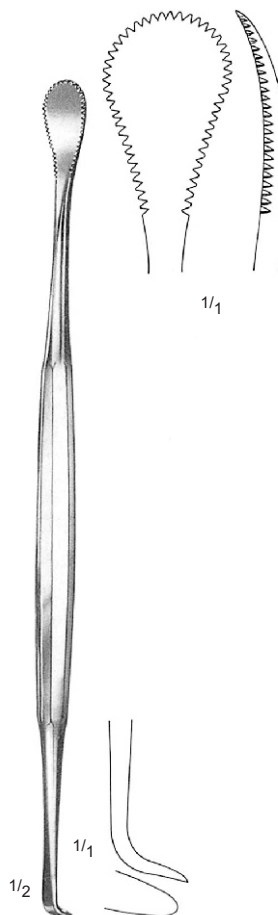

HENKE
 32-018-23
 23 cm / 9"

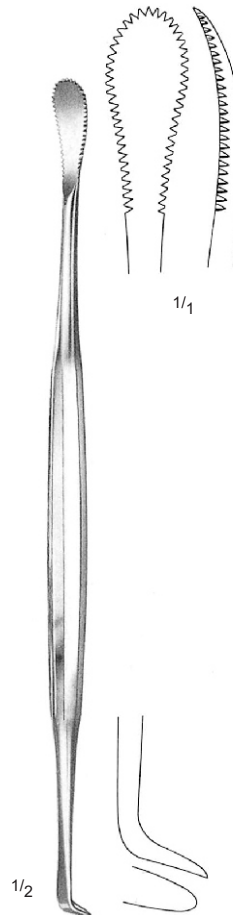

HENKE
 32-019-23
 23 cm / 9"

Tonsillectomy Forceps

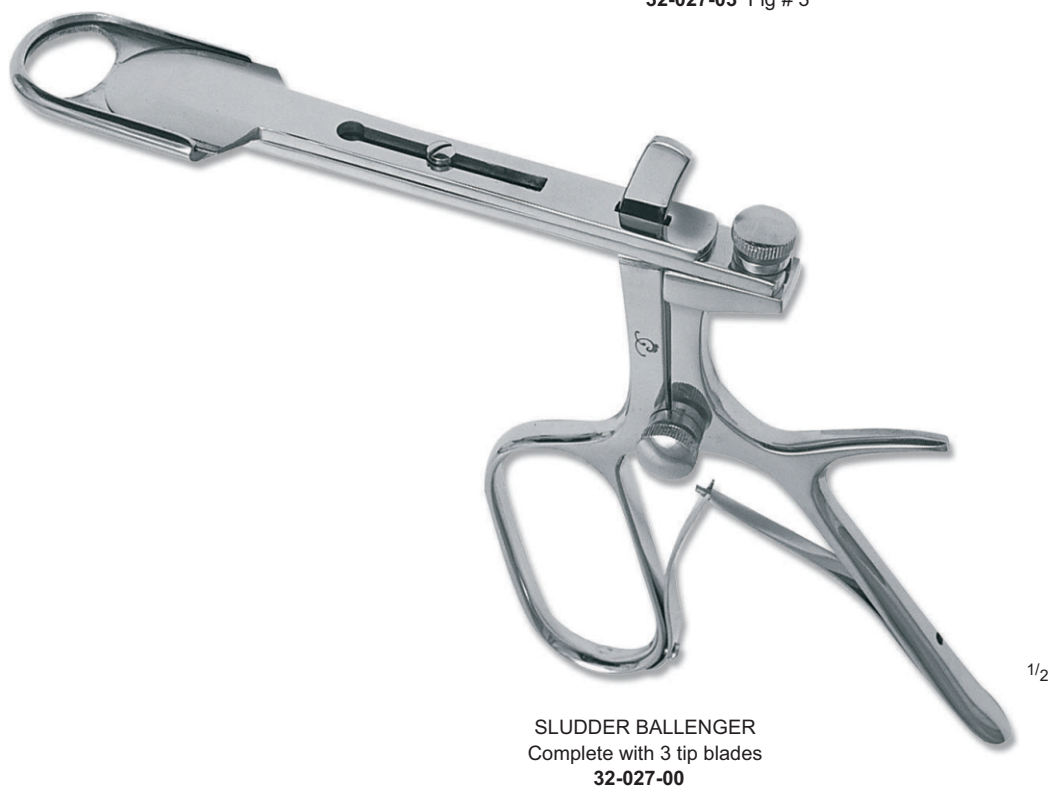
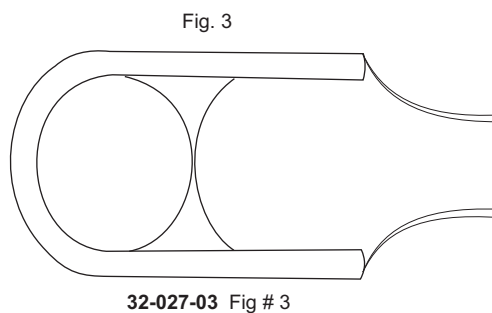
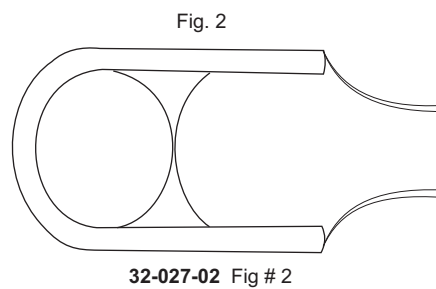
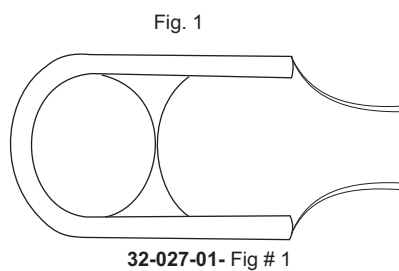

Laryngeal Mirrors, Adenoid Currettes

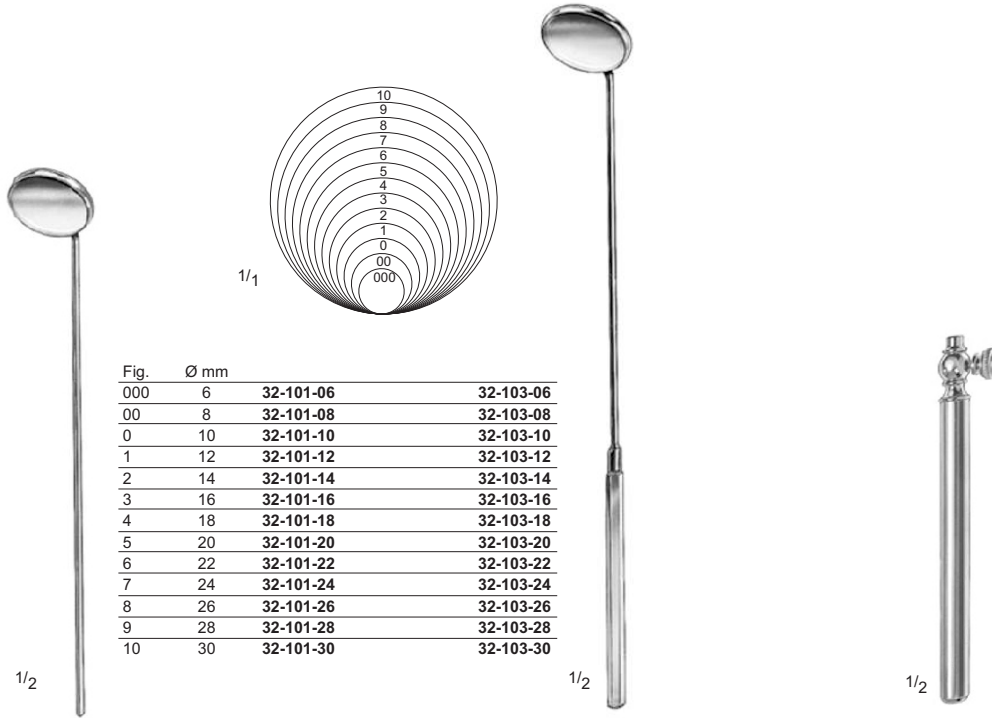
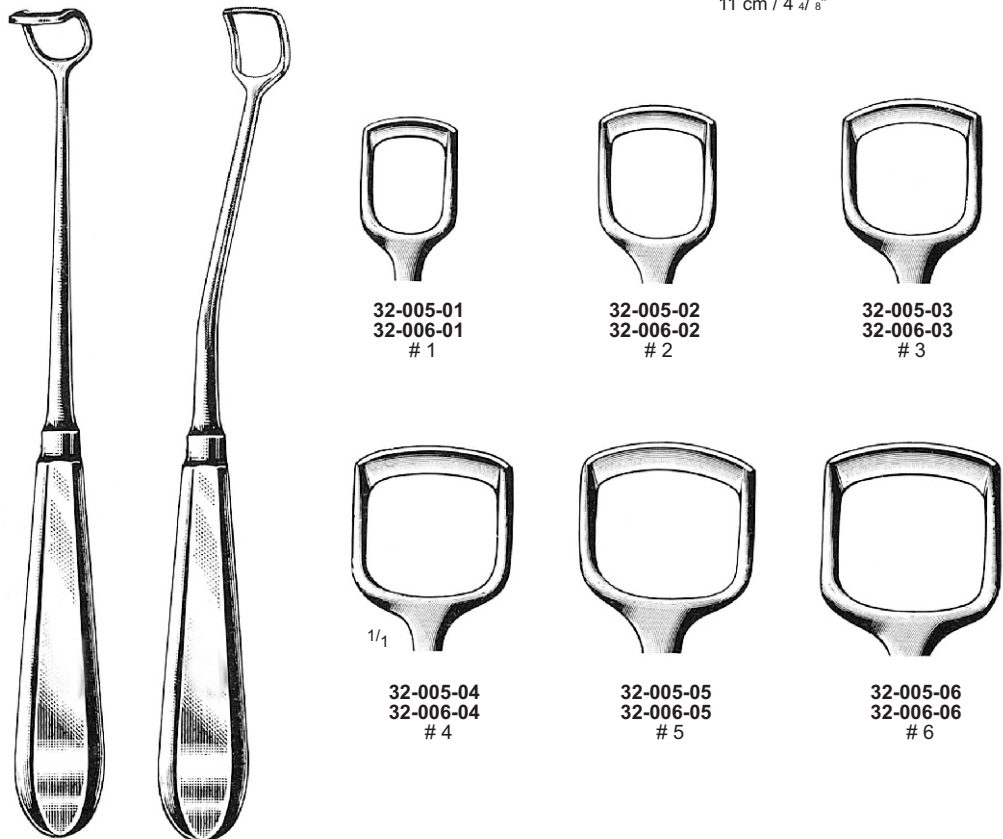

Fig.	Ø mm		
000	6	32-101-06	32-103-06
00	8	32-101-08	32-103-08
0	10	32-101-10	32-103-10
1	12	32-101-12	32-103-12
2	14	32-101-14	32-103-14
3	16	32-101-16	32-103-16
4	18	32-101-18	32-103-18
5	20	32-101-20	32-103-20
6	22	32-101-22	32-103-22
7	24	32-101-24	32-103-24
8	26	32-101-26	32-103-26
9	28	32-101-28	32-103-28
10	30	32-101-30	32-103-30

Laryngeal Mirror without Handle
32-101-01 – 32-101-30
 12 cm / 4 3/4"

Laryngeal Mirror with Handle
32-103-06 – 32-103-30
 22 cm / 8 3/4"

32-100-00
 Handle for Laryngeal Mirror
 with adjustable Screw
 11 cm / 4 1/8"



BECKMAN
32-005-11 – 32-005-16
 22 cm / 8 3/4"

BECKMAN
32-006-01 – 32-006-06
 22 cm / 8 3/4"

Tracheal Tubes, Dilators, Retractors



CHEVALIER-JACKSON
 32-033-04 – 32-034-13

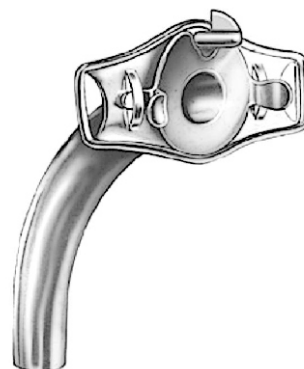

LUER
 32-035-04 – 32-036-13

Fig	mm ø	German Silver	Silver Plated	German Silver	Silver Plated
0	4	32-033-04	32-034-04	32-035-04	32-036-04
1	5	32-033-05	32-034-05	32-035-05	32-036-05
2	6	32-033-06	32-034-06	32-035-06	32-036-06
3	7	32-033-07	32-034-07	32-035-07	32-036-07
4	8	32-033-08	32-034-08	32-035-08	32-036-08
5	9	32-033-09	32-034-09	32-035-09	32-036-09
6	10	32-033-10	32-034-10	32-035-10	32-036-10
7	11	32-033-11	32-034-11	32-035-11	32-036-11
8	12	32-033-12	32-034-12	32-035-12	32-036-12
9	13	32-033-13	32-034-13	32-035-13	32-036-13

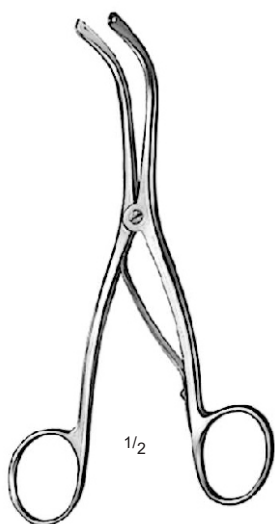

TROUSSEAU
 32-136-14
 14 cm / 5 1/2"

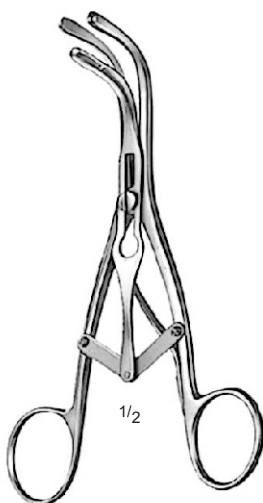

LABORDE
 32-137-14
 14 cm / 5 1/2"



LUKENS
 32-141-17
 17 cm / 6 3/4"



JACKSON
 32-142-17
 17 cm / 6 3/4"

Mouth Gags

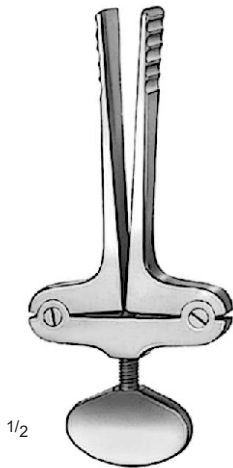

HEISTER
32-205-05
13 cm / 5"

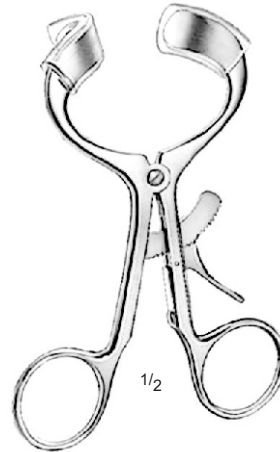

MOLT
32-211-10 – 10 cm / 4"
32-211-13 – 13 cm / 5"
32-211-15 – 15 cm / 6"



JENNINGS
32-221-09 – 9 cm / 3 1/2"
32-221-11 – 11 cm / 4 1/2"
32-221-13 – 13 cm / 5"
32-221-15 – 15 cm / 6"

Mouth Gags

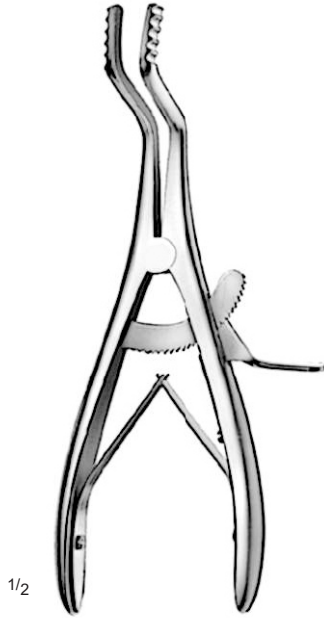

ROSER - KONIG
32-113-16 – 16 cm / 6 1/4"
32-113-20 – 20 cm / 8"

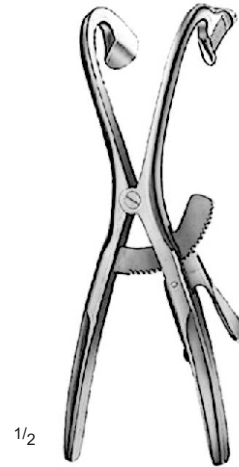

DENHART
32-114-13
13 cm / 5"

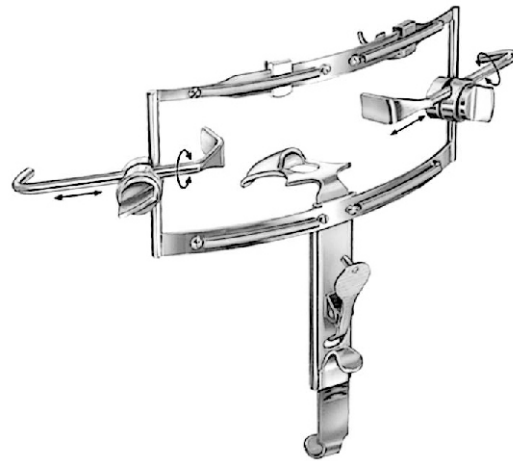

Tongue Depressors



1/2

TOBOLD
32-251-14
 14 cm / 5 1/2"



1/2

HARTMANN
32-252-15
 15 cm / 6"



1/2

WIEDER
32-253-14 – 32-12532-15



32-102-21
 14 cm / 5 1/2"

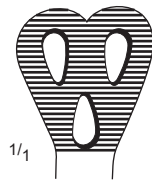

1/1

32-102-22
 15 cm / 6"



1/2

32-261-14 – 14 cm / 5 1/2"
 Stainless Steel

20 mm

23 mm



1/2

STERNBERG
32-264-15
 14.5 cm / 5 3/4"



1/2

BRUENING
32-271-19
 19 cm / 7 1/2"

14 mm

18 mm